

CITES Identification Guide – Turtles & Tortoises

CITES辨識圖鑑—龜類

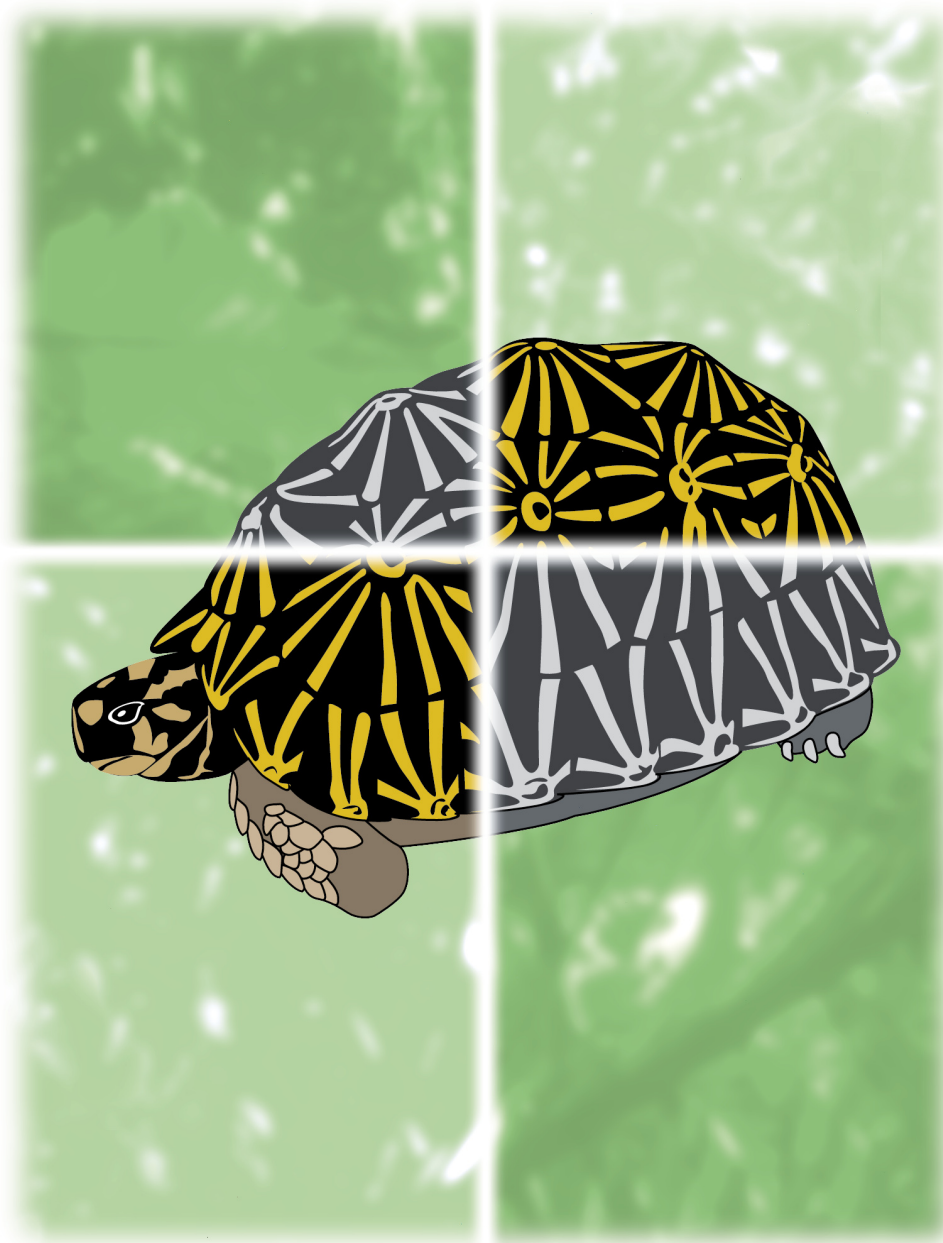

TRAFFIC EAST ASIA-TAIPEI
台北野生物貿易調查委員會

CITES Identification Guide – Turtles & Tortoises

CITES辨識圖鑑—龜類

自民國七十八年野生動物保育法公布施行以來，我國推展野生動物保育的工作已有明顯的進展。舉凡保護區的劃定、棲地的保護、物種的保育，乃至市場的管理與國際貿易的管制等，在在說明我國執行保育工作之成果已有長足之進步；而對於未來中長程保育目標之規劃，亦已逐步完成且漸具規模。

然而保育類野生動物種類繁多，在保育法執行上倍顯困難，尤其物種之辨識更為落實執法工作之主要關鍵所在，龜類物種鑑定指南，有助於龜類物種之辨識並落實其保育。為此，本會特將此等鑑定辨識手冊之編印，列入年度工作之優先辦理項目。並獲知加拿大所編行出版之華約（CITES）附錄龜類物種鑑定指南別具特色，特委請東亞野生物貿易調委員會，經向加方相關單位商得授權後，由台北野生物貿易調查委員會編譯成書。全書不僅蒐錄全球數百餘種龜類物種資料，並著墨其亞種與產製品，其內容豐富、設計新穎，摒除過去一貫以動物之各項生物特徵做為分類基礎之方式，而改以生動有趣之圖繪表現動物重要外型特徵更為本書特色。

期望執法人員參閱本書簡單之介紹與切要之說明指引後，能輕易查閱並迅速辨識物種是否列入保育，係為本書編譯之重要目的。此外，也希望本次中譯本之發行除對於未來其他辨識教材或手冊之編排、設計有所突破外，並提供我國相關單位作為執法上參考，以落實並執行野生動物保育法。

行政院農業委員會
主任委員

謹識

中華民國八十八年
十二月



TRAFFIC EAST ASIA-TAIPEI
台北野生物貿易調查委員會

CITES辨識圖鑑—龜類

中文譯本

辨識CITES管制龜類物種的圖鑑



原創意：依凡·拉夫爾 (Yvan Lafleur)

加拿大環境部執法單位野生動植物組主任

研究、概念、製作：理查·夏綠蒂 (Richard Charette) 加拿大環境部執法單位

嘉勒哥 (Flor Amparo Leyva Gallegos) 墨西哥生物學家

插圖：瓊斯 (Ziggy Jones)、渥依 (Urs Woy)、馬拉巴爾 (Tamara Maliepaard)

設計：馬拉巴爾 (Tamara Maliepaard)

攝影：庫柏 (Ernest Cooper)、格來翰 (Ron Graham) 加拿大環境部

科學顧問：依文森博士 (Dr. John B. Iverson) Earlham學院

中文版編譯：陳添喜、陳揚文、曾詩琴



A project of Environment Canada and TRAFFIC East Asia

編譯：台北野生物貿易調查委員會

印行：行政院農業委員會



IUCN
The World Conservation Union



Introduction

紫色頁介紹

解釋如何使用本圖鑑。

?

目錄

前言	ii
原序	iii
序	iv
譯者序.....	v
致謝	vi
如何使用本圖鑑	
給海關與執行華盛頓公約(CITES)相關人員的訊息.....	?-1
什麼是CITES?.....	?-2
本圖鑑內容所包括的物種.....	?-2
如何確認CITES許可證上所記載龜類物種.....	?-3
如何確認CITES許可證是否有效.....	?-4
如何鑑識未附有CITES許可證的龜類物種.....	?-5
辨識程序的範例介紹.....	?-6
顏色標籤的目的.....	?-11
綠色檢索頁的目的.....	?-12
敘述頁的目的.....	?-13
部分器官、產製品圖標所代表的意義.....	?-14
物種所屬科名之方塊區內容.....	?-15
橘色參考頁的目的.....	?-16
附錄A的內容.....	?-17
附錄B的內容.....	?-18
圖標所代表的意義.....	?-19
尺寸大小.....	?-20
綠色檢索頁	
檢索頁使用的形態特徵.....	1
物種辨識檢索.....	5
部位及產製品.....	11
腹甲特徵辨識檢索.....	13
藍色敘述頁 較易辨識的物種.....	2
黃色敘述頁 較難辨識的物種.....	2
橘色參考頁	
需由專家鑑定的物種.....	1
本圖鑑未列入的物種.....	2
附錄A.....	A-1
附錄B.....	B-1
附錄C.....	C-1

前言

加拿大政府於1975年7月3日簽署成為瀕臨絕種野生動植物國際貿易公約（即華盛頓公約，簡稱CITES）的會員國之一。到目前為止，已有超過140個國家簽署加入華盛頓公約的會員國，而此公約之目的在藉由對野生動植物的貿易管制，來保護大部分受到生存威脅的物種。

在簽署華盛頓公約之後，加拿大政府即委由環境部執行野生物貿易的管制工作，並與政府其他相關部門密切合作。此外，於1992年12月公布的野生動植物保護及國際與省間貿易管制法案（Wild Animal and Plant Protection and Regulation of International and Interprovincial Trade Act），已使加拿大政府在基於華盛頓公約架構下，有極顯著的成效。

於1994年，加拿大環境部出版了「CITES辨識圖鑑－鳥類」一書，隨即於1995年繼續印行了「CITES辨識圖鑑－鱷魚」。由於這些重要資料的發行，得以協助負責執行CITES的加拿大及其他國家相關人員辨識鳥類及鱷魚物種的工作，使這些物種的貿易能更有效地受到管制。

此次這冊新的圖鑑主要在協助針對龜類動物的鑑定工作。過去人類長期將龜類動物當成寵物飼養並利用其各項產製品，而這些物種的生存極易受到威脅，大規模的貿易現象，已使部分種類中的許多族群已消失殆盡。與已出版的鳥類圖鑑一樣，本圖鑑的內容不僅包括CITES保護名錄中的物種，並有在不久的將來亦可能被列入名錄的種類。

加拿大政府於1992年12月簽署了「生物多樣性公約」之後，即盡最大努力以保護全球的生物多樣性。在此，極為榮幸能出版「CITES辨識圖鑑－龜類」提供其他決心保護這些物種的國家參考。

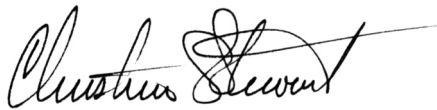

克里斯汀·史都華
加拿大環境部部長

原序

瀕臨絕種野生動植物國際貿易公約（The Convention on International Trade in Endangered Species of Wild Fauna and Flora，簡稱CITES，又稱華盛頓公約），對共同生存在地球上的加拿大人與野生動植物皆具影響。每當有新國家簽署加入CITES締約國，保護野生動物的國際力量將更為壯大。

CITES締約國將賦與一些應盡的義務與責任，締約國需指定一個包括管理機構、科學機構及防偽單位等組織的行政系統，以積極參與公約的落實與執行。

為落實CITES的目標，必須涉及許多的工作任務，包括相關許可證的簽署與確認、物品的檢驗、動物活體的照料、易壞產製品的適當保存等，皆需要夠資格人員的實際參與。目前並無任何一個CITES締約國有統籌分配相關人力與經濟資源的專責機構，來確保嚴格管制各國間的貿易活動，各CITES相關行政管理機構皆需與其他機構相互配合，才能達到CITES的真正目標，在不同的責任區域內，履行公約精神以及其規範。

這些機構人員常會覺得自己的專業訓練不夠，他們認為最好將CITES的執行工作留給相關專家。其實，大多數負責CITES執行工作的人員，如海關、警察、保育官員或是動植物產製品檢驗人員，皆能夠完成辨識標本以及查驗許可證等重要的任務。

加拿大環境部已發展出一系列不需經過專業訓練，就容易上手的辨識圖鑑，主要是為了協助第一線的執法人員，有效控制受管制物品的進出口。

這本龜類圖鑑是與墨西哥(PROFEPA)的同事合作完成，群策群力，始完成這本高品質的鑑定工具。

我希望這本圖鑑能激勵您致力於取締野生動物非法交易，保護備受國際貿易威脅的野生動植物物種。



依凡·拉夫爾
加拿大環境部執法單位野生動植物組主任



序

人類文明自十九世紀進入工業文明，雖然帶給部分人類前所未有的幸福，同樣地帶來災禍，尤其以無限制的濫用自然資源，不僅人類已經開始自食惡果，更造成地球物種的大滅絕。人類是地球自然生態的一環，自然無法離開完全孤立於地球自然生態體系；如何永續地使用自然資源、維護生物的多樣性，毫無疑問是人類文明由二十世紀進入二十一世紀的最重要課題。

地球上的各種物種構成自然資源的主體，要能永續地使用，必須先能對自然物種資源有所認識。在現今運輸發達地球村的時代，任何一國的保育執法官員都有可能面對來自世界各地的動植物物種，而且也會有必須判斷是否為保育類物種的機會；然而面對芸芸眾多物種，即使受過生物學科訓練者，亦有難以判別辨識的情況發生。加拿大政府有鑑於此，特別設計一系列CITES辨識圖鑑，該系列圖鑑，以使用者的實用導向為出發點，不僅簡化了繁瑣的鑑定流程，也在降低複雜度與保持精準度方面有相當傑出的表現，對於非生物背景的讀者或使用者有著極大的助益。圖鑑同時以中文、英文、法文、西班牙文刊行，在國際間亦有好評，廣為各國政府保育官員使用。

東亞野生物貿易調查委員會（TRAFFIC East Asia）有幸獲得加拿大政府環境部的授權，編譯CITES辨識圖鑑中文版，並在行政院農業委員會的支持下，委由台北野生物貿易調查委員會(TRAFFIC East Asia- Taipei)進行翻譯編輯中文版的工作，本龜類圖鑑繼CITES鳥類、鱷魚辨識圖鑑，已為該系列第三本圖鑑的刊行，特此再次感謝行政院農業委員會的贊助，也希望此系列圖鑑能繼續發行中文版，並希望不僅在台灣地區能發揮此圖鑑的功效，全球使用中文的保育人士亦能受惠於此圖鑑。

東亞野生物貿易調查委員會總監
苗朱迪(Judy Mills)

譯者序

龜在東方有截然兩極的待遇，一方面是長壽、吉祥的象徵，放生、祈福的對象，另一方面由於其溫馴的性質，成為被食用、豢養的對象，由於龜類動物長久以來與人類關係密切，成為捕獵的對象，加上其棲息地的破壞，許多的龜類物種已面臨瀕臨絕種的命運，而被列入CITES的保護管制，以現有龜類動物大約有270種，要由其中分辨出瀕危物種，對於一般執法人員確實為一大難題，因此一個實用的辨識參考工具書是極為急迫的。且此參考工具書不僅可供政府相關人員執法所用，亦可提供與龜類動物相關行業，如中藥材進口商、水族（寵物）相關業者等，避免交易瀕危物種或遵守相關法律的規範。

本龜類圖鑑為加國政府出版的「CITES辨識圖鑑」系列叢書中的第三本中文譯本，其檢索方式以便利實用為原則。就如同第一本CITES辨識圖鑑—鳥類，為了從9,000多種鳥類中，簡易快速辨識出數百種CITES附錄鳥類，鳥類圖鑑雖省略了若干形態細節上的說明，卻以色彩的系統說明，明確地達到初步的鑑識工作；本龜類圖鑑亦秉承此分類體系，以體甲上之形態特徵，歸類說明，佐以交互參考的方法，期使達到有效快速的辨識出受管制的物種。

在使用傳統中藥地區，龜板為龜類動物的主要交易形式之一，本龜類圖鑑亦針對龜板的辨識多加著墨，然而在傳統中藥市場中的龜板可能來源中，有部份種類例如印度稜背龜、眼斑沼龜是屬於CITES附錄一的物種，緬甸陸龜、凹甲陸龜、印度星龜是屬附錄二，也有許多種類不在現有的管制名錄中，為方便辨識取用之龜板物種，中文譯本亦增列附錄C—常見藥用龜板來源物種表，以縮小檢索範圍，作為參考之用。希望中文讀者在使用本圖鑑後，能夠不吝向台北野生物貿易調查委員會提出指教，使本系列圖鑑再版時得以更近完美。

陳添喜、陳楊文
Tien-Hsi Chen & Vincent Chen

致謝

I would like to extend my heartfelt thanks to Yvan Lafleur, Chief of the Wildlife Division, Office of Enforcement, Environment Canada, for having allowed us to develop this new CITES Identification Guide; to Mtro. Antonio Azuela de la Cueva, Procurador Federal de Protección Ambiental, and Lic. Víctor Ramírez Navarro, Subprocurador de Recursos Naturales de la Procuraduría Federal de Protección Ambiental (PROFEPA), for allowing Flor Amparo Leyva Gallegos to collaborate on this project; to Flor for her valuable contribution in the scientific revision of the Guide and for having accepted the challenge of spending several months away from her native country; to Dr. John B. Iverson, who kindly agreed to revise all drawings; to M. en C. Gustavo Aguirre Leon, Titular Researcher at the Institute of Ecology, A. C., for providing us with the list of common Spanish names; to Georgina Santos Barrera of the Faculty of Science of the University Autonomous of Mexico, for her support with the taxonomy; a very special recognition goes out to Tamara Maliepaard, who accepted to design and layout this new guide with her usual concern for perfection; to Ziggy Jones and Urs Woy for illustration production; to CITES Secretariat, for his assistance in promoting the CITES guides and for giving us permission to use the turtle and tortoise illustrations from the CITES manuals; to the World Customs Organization of Brussels, for its help in promoting the project; to Marcus Phipps, from TRAFFIC East Asia, and Craig Hoover for their advice on species marketed in South-East Asia; to J. Ventura, from U.S. Fish and Wildlife Service for his advice; to Ernest Cooper and Ron Graham, Environment Canada, for their outstanding photographs; and to Rita Guertin and Carmen Bigras, for their invaluable administrative support.

Richard Charette
National Coordinator, Inspections
Office of Enforcement
Environment Canada



本書得以順利印行，譯者要特別感謝行政院農委會贊助此翻譯計畫，原作者理查·夏綠蒂(Richard Charette)先生對內文的諸多指導，曾詩琴小姐在譯文、版面上的細心編輯，張文宗先生的協助印刷，以及林育正先生的美術製作。

如何使用本圖鑑

給海關與執行華盛頓公約(CITES)相關人員的訊息

由於自然棲息環境的破壞、國際寵物及其產製品貿易的盛行，目前已導致許多龜類物種面臨瀕臨絕種的危機。但貴國若能主動執行龜類動物貿易管制，將可以幫助扭轉這種趨勢。

本圖鑑的目的在協助您辨識貿易常見龜類物種，有些是受華盛頓公約（以下簡稱 CITES）所管制，但有些種類並不受管制（見 ?-2 ）。各國海關人員無不希望藉由一套簡明工具的輔助，就能辨識通關的龜類物種，本圖鑑即是為符合這種需求而設計。在使用本圖鑑前，並不需要先具備有龜鱉類有關的基本知識，僅需藉由圖鑑中的指引步驟與說明，就可以辨識目前國際貿易的常見龜類物種。

雖然內容有些差異，本圖鑑格式主要是依據已出版的「CITES辨識圖鑑—鱷魚」而編寫，大家應該已經十分熟悉這種編排方式。

本圖鑑綠色檢索頁的圖示標示出鑑別不同物種的形態特徵。首先，是比對您手邊的標本與檢索頁上所描繪的形態特徵，然後依循檢索頁的導引，查閱藍色或黃色敘述頁，即可獲得有關物種的圖示及更多相關訊息，以協助您確認辨識的物種。

本圖鑑藍色敘述頁包含最容易辨識的種類，您很容易就可辨識這些物種。此敘述頁使您的觀察能力更銳利，為進階到黃色描述頁做好準備。

黃色敘述頁的物種有時在外形上極為相似，需仔細比對標本的各种形態細節，才能辨別不同物種之間的差異。雖會有一些困難，在經過練習後，您即能正確辨識藍色頁與黃色頁所有龜鱉類物種。不論您是新手或專家，本圖鑑適用於執行華盛頓公約的相關官員。由藍色頁至黃色頁，其困難度將逐漸增加。

本圖鑑橘色頁的龜類物種需要由相關專家來鑑定；這些研究爬行動物的專家將由貴國的 CITES 相關機構來認定，以協助相關人員執行任務。

在使用本圖鑑之前，請先詳細閱讀紫色敘述頁的說明，其中將介紹辨識的步驟，然後您將開始接受辨識各種龜類的挑戰。我們確信您將輕鬆勝任這項工作。

?

什麼是CITES

瀕臨絕種野生動植物國際貿易公約〔The Convention on International Trade in Endangered Species of Wild Fauna and Flora (簡稱CITES)〕，又稱華盛頓公約，是由超過一百四十個國家所共同簽署的國際公約，其目標在管制部份野生動植物種類及其部位器官、產製品的國際貿易行為。受管制的動植物物種名錄是由每二年舉行的締約國大會所更新，此管制名錄刊載CITES動植物種名，並分為附錄一、二及三等三類附錄物種。

附錄一 (Appendix I) 是稀有或瀕危物種。禁止對這些物種進行主要為商業目的之貿易行為。因此，必須同時具備輸出國所核發的CITES輸出許可證和輸入國所核發的CITES輸入許可證才能進行國際貿易。

附錄二 (Appendix II) 目前並非稀有或瀕危物種，若沒有適當的貿易管制，這些物種亦將逐漸瀕危或稀有。須事先具備輸出國所核發之CITES輸出許可證，輸入國才能許可這些物種的輸入。

附錄三 (Appendix III) 是尚未瀕危的物種，但被要求列入附錄三的國家所管制 (國名會列在附錄三旁的括號內)。若與列名國家交易附錄三物種時，須具有輸出國所核發之CITES輸出許可證；若不與列名國家交易該物種時，依公約要求，亦須要有原產地證明或再輸出證明。

下列圖標將不斷出現在本圖鑑，請注意其含意：



附錄一、二或三物種
此類物種貿易受CITES管制，必須確認備有相關的CITES許可證



此類物種貿易不受CITES管制，不須具備CITES許可證



需暫時扣留，請專家鑑定

本圖鑑內容所包括的物種

本圖鑑中不僅包含CITES所管制的物種，並包括一些非CITES所管制但涉及商業性買賣物種，其中包括：

- 自1997年6月所生效的CITES附錄一、二及三內所有龜物種或屬；
- 某些目前並未受CITES管制的貿易物種，但這些物種可能會被管制或常與CITES物種混淆。

在無亞種存在的情形，圖示是僅以指名種來代表 (如 *Caretta caretta*)，若同一物種內有數個亞種時，圖示則以指名亞種代表 (如 *Eretmochelys imbricata imbricata*)。為辨識其他在本圖鑑沒有說明的亞種 (如 *Eretmochelys imbricata bisssa*)，您可能需諮詢專家。

所有CITES管制物種會標示  圖標，在之前已出版的圖鑑也曾經使用。

如何使用本圖鑑

如何確認CITES許可證上所記載龜類物種？

翻至附錄B（見 ?-18）對照許可證所記載的物種名稱，記下其學名（第二欄）及進一步參考的頁碼

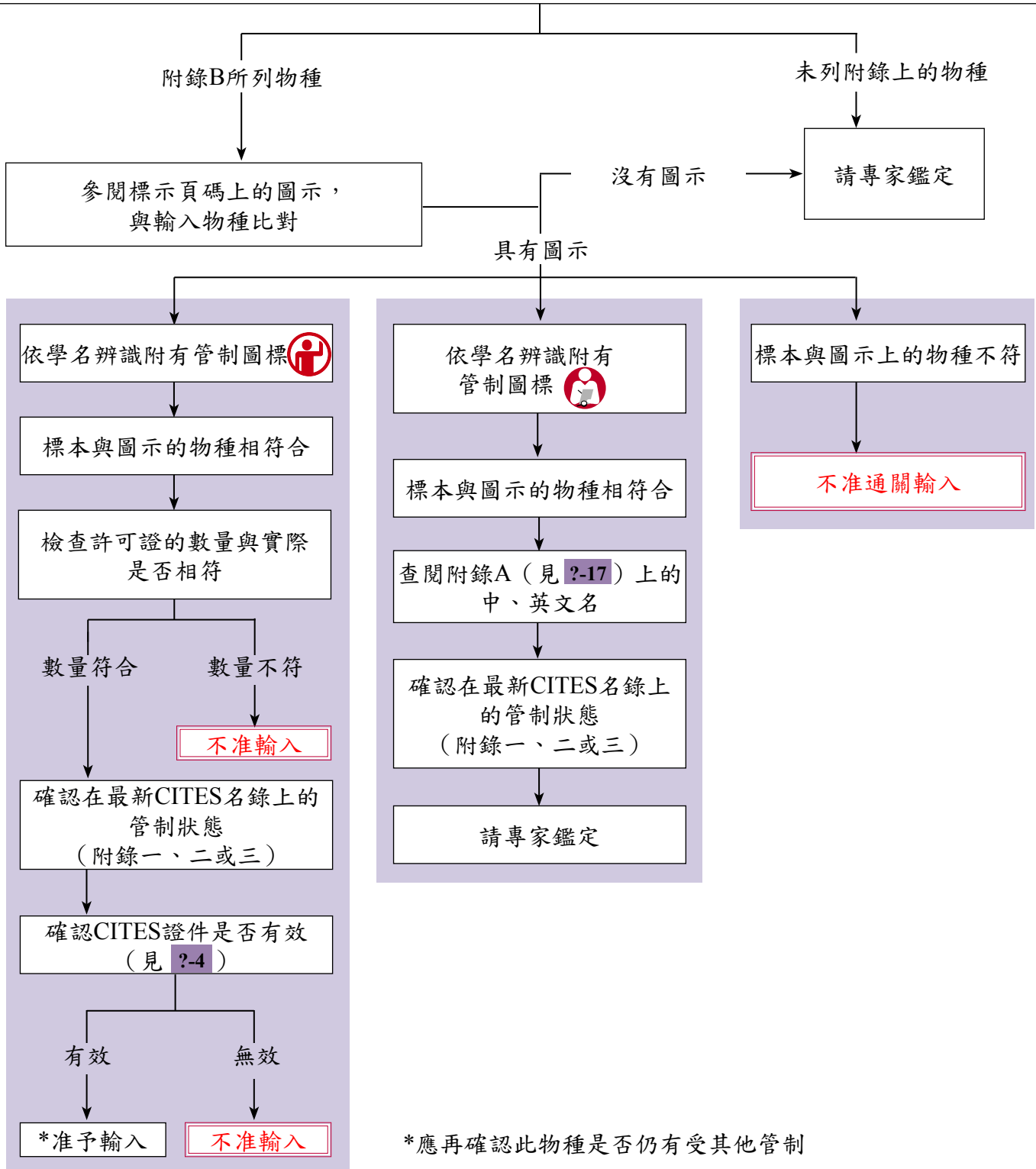

如何使用本圖鑑

如何判斷CITES許可證是否有效？

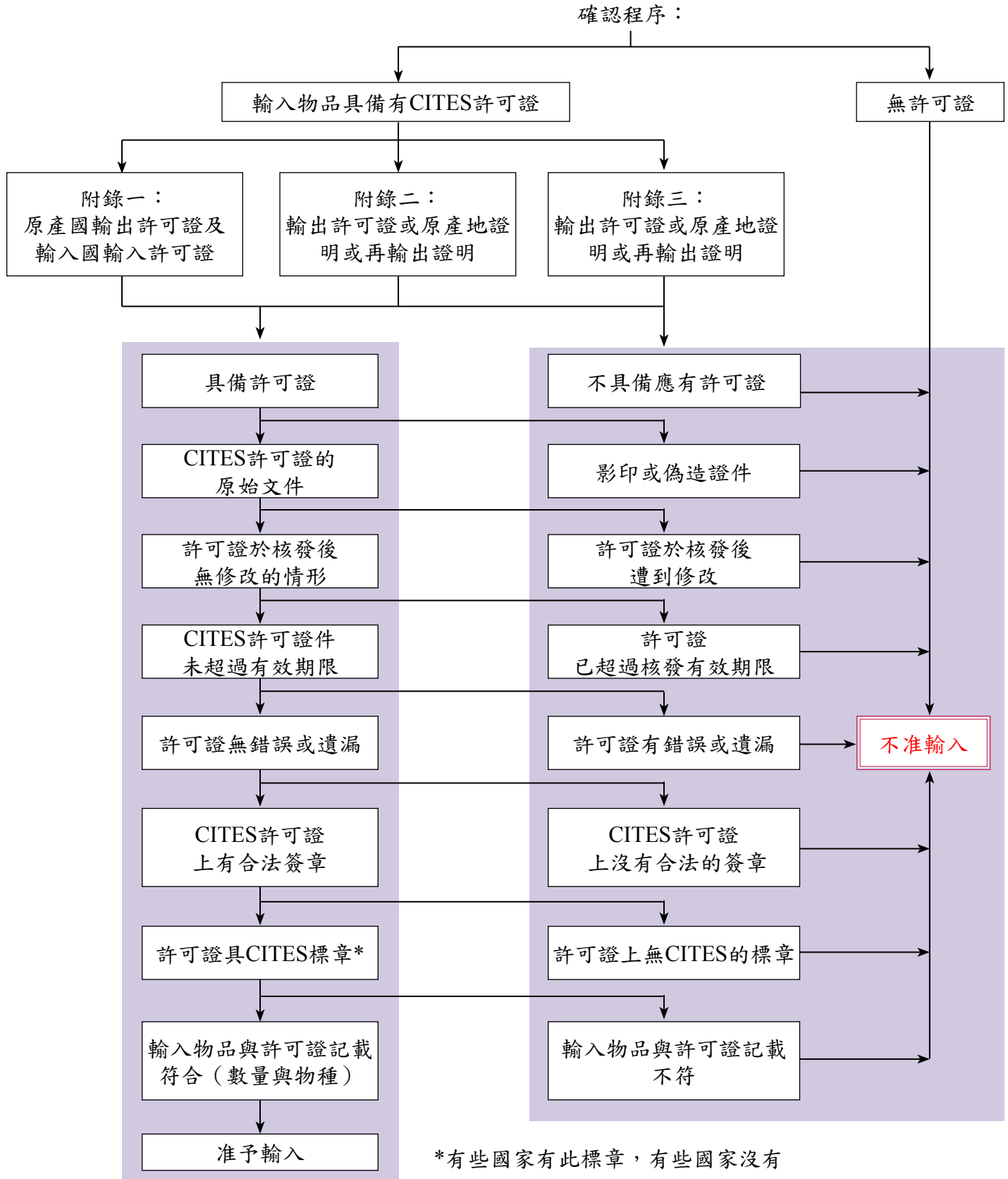

如何使用本圖鑑

如何辨識未附有CITES許可證的龜類物種

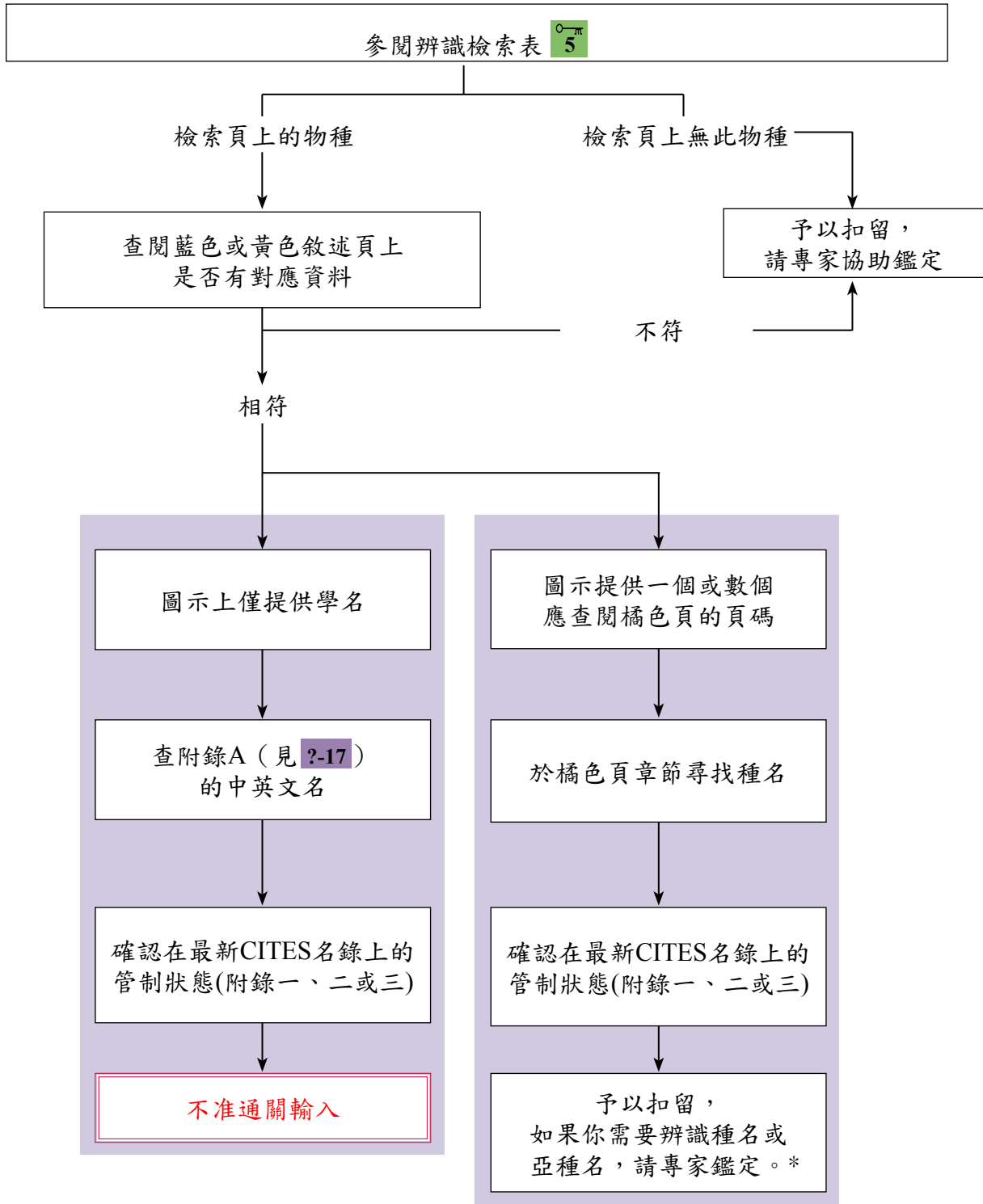

*如果物種某一亞種是受CITES保護，就需要鑑定。

如何使用本圖鑑

辨識程序的範例介紹

辨識的程序主要是比對標本的外形特徵，然後遵循檢索表內的種種程序，辨識出大多數可能的物種，再利用藍色或黃色敘述頁中的圖示或資訊，將可進一步確認所要辨識的物種。

在處理活體標本時，需隨時小心防止被咬。要記住，即使是體型最小的活體標本，亦可能對您造成嚴重的傷害。要牢牢捉住其背甲的兩側，避免被其嘴巴咬到及爪子抓到。為避免細菌感染，處理標本後，一定要用殺菌的肥皂洗手或戴手套處理。

幼龜的特徵有時會與成龜有極大的差異，尤其在背甲的發育及顏色的變化。隨著成長，原來鮮明的顏色將變淡，背甲上的鋸齒狀突起亦將消失，在敘述頁中將會提到這些外形的差異。當您有任何疑慮時，不必遲疑，立刻尋求相關專家的協助。

首先以本頁圖中的種類為例，示範本圖鑑的使用方法：

範例



第一步是要讓您熟悉辨識檢索表上所使用的形態特徵，從 [1](#) 至 [4](#) 頁將提供一系列的圖示來標明您要辨識的特徵，以及所使用名詞的定義，如果您已經熟悉這些名詞，就能開始利用辨識檢索表，進行辨識物種的程序。為了能正確地辨識出物種，請務必依序查閱 [5](#) 至 [10](#) 的所有檢索頁上的指引及說明，是極為重要的。

範例（續上頁）

要記住檢索頁上的代表物種是從具有相似外形特徵物種中所選出的範例，不要試圖去將您的標本完全吻合檢索頁上的圖示，而是要依各敘述頁上的圖說指引找出相對應的物種，檢索頁主要在顯示特徵，而敘述頁則是在描述物種。

在 ^{0-π}5 頁首先呈現四肢呈（船）櫓狀，並具一或二爪甚至不具有爪的科。現今只有七種海龜（所有物種皆受CITES保護）及豬鼻龜具有此類特徵。您將發現我們的範例並不具有相似特徵，因此繼續翻至 ^{0-π}5 頁下半部的章節。

此章節所標示的是 *Malacochersu tornieri*（陸龜科Testudidae），具有如大象般圓柱形的四肢，趾間不具有蹼狀構造，背甲扁平有如圓鬆餅。仔細比對我們的範例即可發現，其四肢並非呈圓柱形，背甲亦非十分扁平，趾間具有蹼，依此下方指引，翻至 ^{0-π}6 頁。



在 ^{0-π}6 頁上介紹其他陸棲性的陸龜（陸龜科Testudidae），所有物種皆受CITES保護，具有如類似大象圓柱形的四肢，趾間無蹼，背甲隆起。我們的範例物種趾間有蹼，背甲較為扁平，能適應於水域的環境中活動，並不符合其特徵。現在可翻至 ^{0-π}7 頁，找到趾間有蹼，背甲扁平的物種。

在 ^{0-π}7 頁的第一部分介紹鱉科 Trionychidae 的物種，這些物種背甲柔軟，不具有鱗片。我們的範例物種的背甲上有清楚的盾板，使背甲較為堅硬，因此可確定並不屬於鱉科的物種。





接下來的部分則描述蛇頸龜科Chelidae（澳—非洲側頸龜）及側頸龜科Pelomedusidae（非—美洲側頸龜）的物種，這兩科的物種會將頸部彎曲在背甲側邊，不像其他的龜類將頸部縮回龜甲內。這兩科物種的最大特徵是具有間喉盾，使腹甲盾板數成為13塊，而其他的物種僅有12塊。在檢視我們的範例標本後，可發現僅有12塊，因而可繼續翻至 ^{0-π}8 頁。

範例（續上頁）

 **8** 頁說明三個科（即中美河龜科Dermatemydidae、鱷龜科Chelydridae、平胸龜Platysternidae）的特徵，此三科僅有四個物種，皆具有上緣盾（紅色部位），極容易與其他物種區別。鱷龜科中的二個物種腹甲板呈十字形；而平胸龜科僅包含有一個物種，其頭部極大，無法縮入龜甲內。我們的範例並不具有上緣盾的特徵，腹甲亦與圖示中的形態不同，因而可翻至  **9** 頁。

在  **9** 頁上標示麝龜科Kinosternidae的物種，背甲具有23塊緣盾是此科物種的特徵。而其他科的物種則具有24或25塊。因為我們的範例具有25塊緣盾，明顯並不屬於此科的種類。

在  **9** 頁剩餘部分則標示包括多數淡水龜種類的澤龜科（Emydidae）特徵。檢索表首先標出具有腹甲韌帶特徵的物種，此構造可使腹甲與背甲緊密閉合，得到較佳的保護效果。但有些物種的腹甲韌帶構造於幼體時或甚至成體都不明顯，要檢查出是否有韌帶構造，可壓迫腹甲的兩端，看是否能夠活動。在檢視我們的範例標本後，可發現其腹甲並不能活動，不具有韌帶構造，因此可翻到  **10** 頁。

在  **10** 頁上標示澤龜科其他物種的特徵。在此必須檢視我們的範例標本背甲是否具有一道、三道或沒有稜脊。通常以肉眼即可看出這些突起稜脊，有時以手觸摸更能感覺其存在。在敘述頁中將提到有些種類的稜脊，會隨著年齡的增長而消失。我們的範例標本僅具有一道稜脊，因此現在檢視其背甲後緣是否有鋸齒狀突起。鋸齒狀突起亦可能隨著年齡而消失，如果在辨識體型較大的個體時，應查閱本圖鑑其他相關章節（是否具有稜脊或突起鋸齒狀）。我們的範例標本之背甲邊緣具有突起鋸齒狀，因此可直接翻至 **51** 敘述頁。

第 **51** 頁開始簡單介紹澤龜科Emydidae（見 **?-15** 頁），於本頁上方顯示其輪廓圖及部分型態特徵。在陰影區標示此科中12種屬於CITES附錄一及二的物種，並有  的圖標。此12個物種必須具備有效的CITES許可證才能貿易，其他的82種並未受CITES保護，但可能在貴國國內是另受管制的。

如何使用本圖鑑

為完成鑑定程序，可依序翻閱敘述頁上所有的描述，在每頁下方的有箭頭指示建議參閱的頁碼。以本範例而言，我們應參閱 51 至 55 頁。

我們的範例明顯為 52 頁上所描述的 *Pseudemys scripta*，此物種名稱後方有  的圖標，表示並不受CITES的管制。利用 *Pseudemys scripta* 的學名，您可查閱附錄A（見 ?-17）中相對應的中英文名。

在您實際進行辨識的過程時，如您所欲辨識的標本有明顯的特徵，將不難查到相對應的圖示。如果您仍無法確認，翻回所有建議的敘述頁，並再仔細比對每一頁上的圖示。但請記住，同一種內的不同個體可能會因其地理分佈、性別及不同亞種間而有所差異。例如盾板的排列與形狀、或背腹甲的花紋特徵皆會有差異，因此您所檢視的標本可能會與圖鑑上的圖形稍微有所出入。

在 55 頁上所說明的物種其幼體與成體，皆具有不明顯的稜脊或鋸齒狀凸起。這些特徵極容易被疏忽，但您可以由本圖鑑其他說明的地方導引辨識出此類物種。如果您尚未能辨識出您的範例標本，就詳細參閱 55 頁中所指示的所有頁碼以得到更多的資料。

其他範例

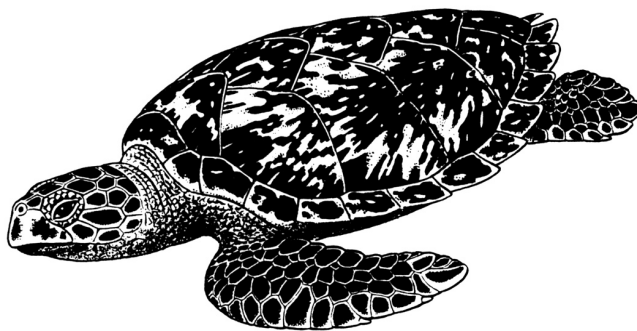

Eretmochelys imbricata



如果發現標示有  圖標的物種，您必須檢視在CITES管制程序中的海關文件。首先是確認該物種在最新CITES名錄中的管制狀態（附錄一、二或三），然後再檢查有關特定物種（參閱 ?-4）所需的CITES文件是否有效，如果其許可證是有效的，該物種的輸入將是合法的，除非貴國對該物種另有其他管制。

如何使用本圖鑑

因為玳瑁 *Eretmochelys imbricata* 所有亞種皆受CITES所保護，並不需要辨識至亞種或諮詢專家，除非只有其中某一亞種受CITES管制或在貴國有特殊規定，才需進一步請求相關專家的協助。

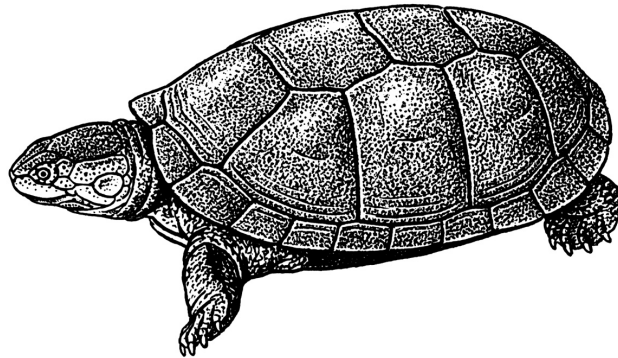

在前頁的例子中，圖示顯示部分器官或產製品都是源自此物種（見 ?-14）。此圖示提到其肉、蛋、背甲及背甲所製成的珠寶都進行交易販售。

在圖鑑中如第 30 頁當出現某一物種有一或數個號碼及  的圖標時，在辨識過程即需諮詢相關專家。先查閱橘色參考頁（見 ?-16）中所建議的物種名稱，再請求專家鑑定。在橘色頁中也列出本圖鑑所未說明的物種名錄。



 Spp. PE-1-5-8-10 1

腹甲辨識檢索

仔細查對  至  頁中所說明的特徵，亦可由腹甲辨識出物種的名稱。您將發現依據外形特徵而排列的所有腹甲圖形。當您找到與您手邊標本相對應的腹甲圖形時，依指引翻至敘述頁，即可得到更多的相關資料。

如何使用本圖鑑

顏色標籤的目的

?

? 章節解釋如何使用本圖鑑。



章節說明如何進行辨識的程序，包括檢索頁。

?

藍色敘述頁 的圖示內容主要為容易辨認的龜類。

黃色敘述頁 圖示中的龜鱉物種或亞種，需仔細觀察或需要諮詢專家。

橘色參考頁 為需請專家鑑定的龜類物種及本圖鑑未說明物種的名錄。

A

淺灰色附錄頁 為附錄A，提供本圖鑑內曾敘述的所有龜類物種之學名，學名乃依照字母的順序排列，並附有中英文名。

B



深灰色附錄頁 為附錄B，依英文字母排列順序列出每一物種的學名與英文名，及該物種在圖鑑中出現的頁碼。



C





深灰色附錄頁 為附錄C，為常見藥用龜板來源物種表，學名乃依照字母的順序排列，並附有中英文名。

如何使用本圖鑑

綠色檢索頁的目的

檢索頁中的  至  頁乃說明本圖鑑中龜類動物之形態特徵，並提供本圖鑑中所使用特殊名詞與其定義。

檢索實際上是由  開始至  頁，但請記住此處所說明的種類，皆僅是例子，不要將您的標本直接比對檢索頁的圖示，檢索頁設計的目的是在突顯主要的辨識形態特徵，經由這些特徵可導引您繼續至藍色或黃色的敘述頁，在此將可辨識出標本的物種名稱。

在  至  頁上包括其部分器官及產製品的圖片，而在  至  頁含有由腹甲特徵辨識物種的檢索。

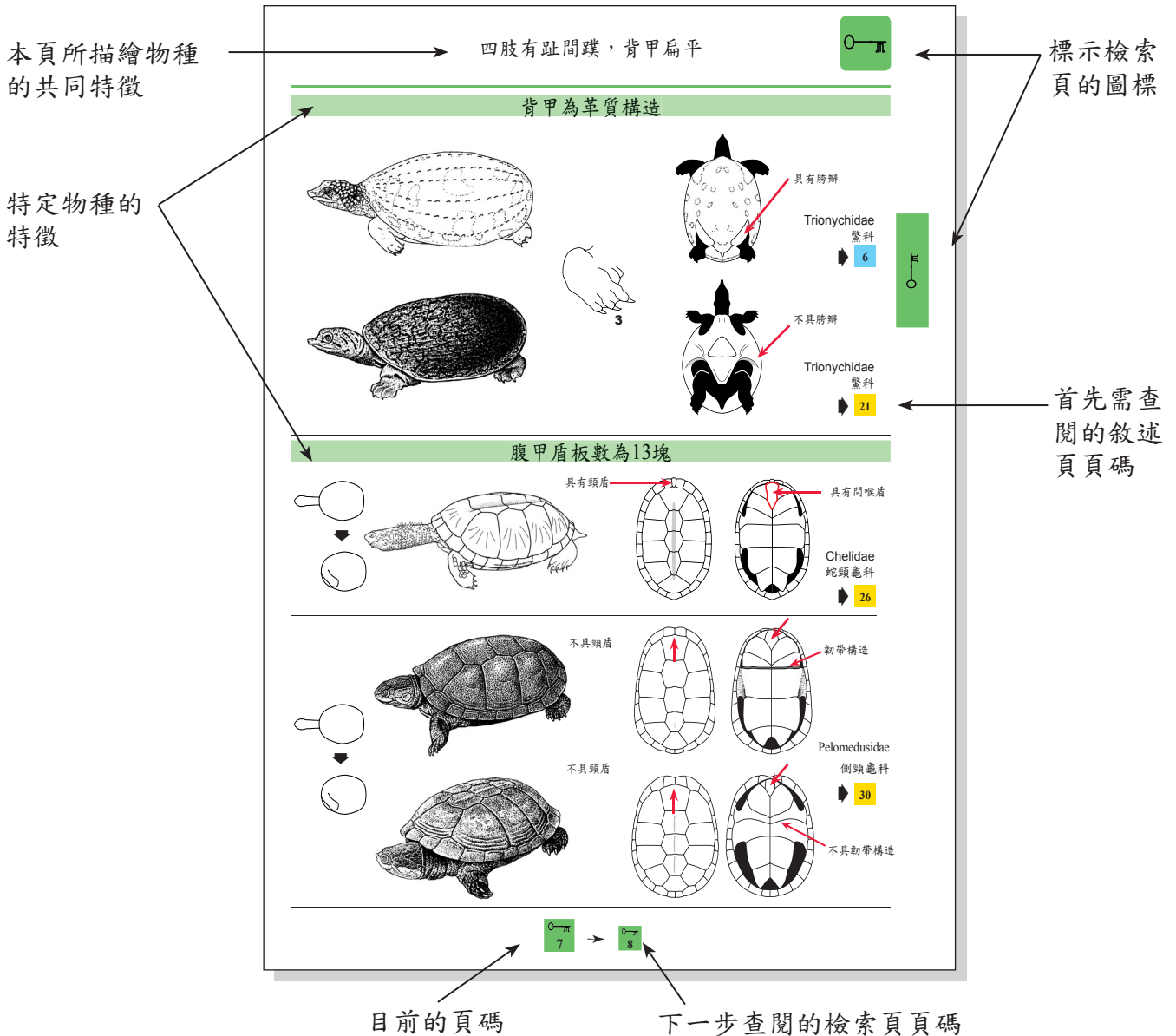

如何使用本圖鑑

敘述頁的目的

敘述頁乃在說明不同龜類物種的特徵。

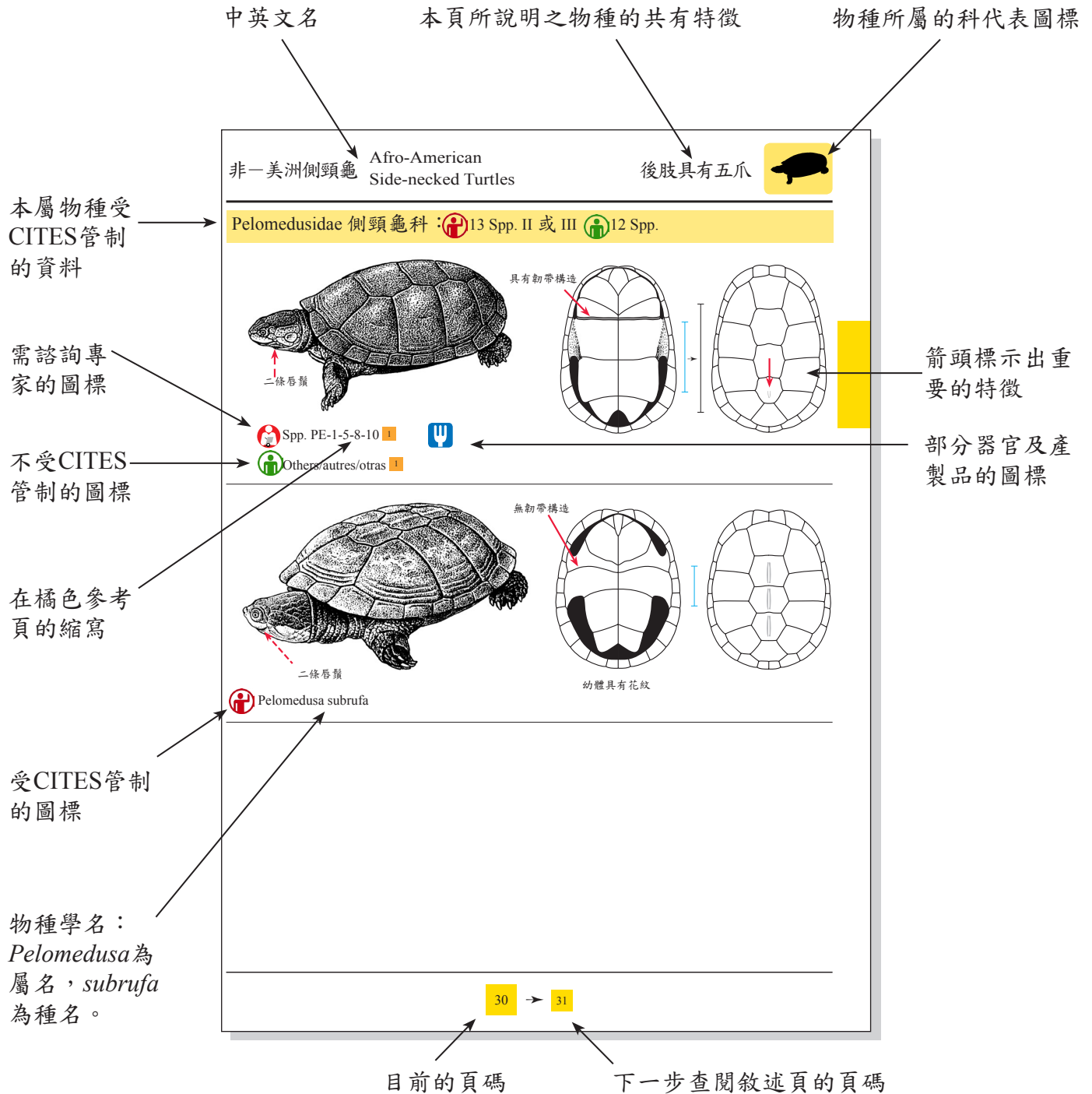

如何使用本圖鑑

部分器官及產製品圖標所代表的意義

這些圖標會出現於黃、藍色敘述頁的學名之後，這顯示該物種有以下的顯著貿易形式：



食品，如肉類罐頭



皮革製品，如皮鞋、皮夾、皮包、皮帶等



背甲製品，如樂器、髮梳、小盒子等



蛋





珠寶，如項鍊、手鍊、耳環、眼鏡框等



其它各類產製品，亞洲傳統藥物、燈具、剝製標本等



油脂

請參閱  及  頁中，有關這些部位器官和產製品的相關例子。

物種所屬科名之方塊內容

當某些物種或某些屬（相近物種所組成的小群集）具有一些共同特徵時，科學家會將他們歸類成關係相近的一群，稱之為同科。

在藍色和黃色敘述頁中，說明物種所屬的科名會在上方的方塊區中標示出來，其後方並標明本科中所有受CITES附錄中所管制的物種數及不受CITES管制的物種數。某科中被CITES所管制的物種數愈多，您就需倍加注意。這些數據是依據1997年開始生效的CITES管制物種名錄，但因每次CITES的雙年會中都會對該名錄進行檢討及修改，這些數據只能作為一個概略值。



科名

圖示與文字表示此科中有6種是被列於附錄一、二或三中，受CITES所管制，另有17種不受CITES管制*

鰓 Softshell Turtles
背甲具眼斑及疣凸

Trionychidae 鰓科： 6 Spp. I, II 或 III 17 Spp.

具有四至六塊眼斑

黃色

Aspideretes hurum

*Nilssonina formosa**

*N. formosa 鼻端上方並無黃色斑點

幼體具有疣凸

黑色

Aspideretes gangeticus

*Aspideretes leithii**

*A. leithii 背甲前段具有疣凸

幼體具成排疣凸及四塊眼斑

21 → 22

*請注意縮寫“Spp.”表示有數個物種，“Sp.”則表示僅有一個物種；“Ssp.”代表僅有一個亞種，而“Sspp.”為數個亞種。

如何使用本圖鑑

橘色參考頁的目的

橘色參考頁中包括在藍色和黃色敘述頁出現的物種，但需請專家鑑定及本圖鑑中未列入的物種名錄。

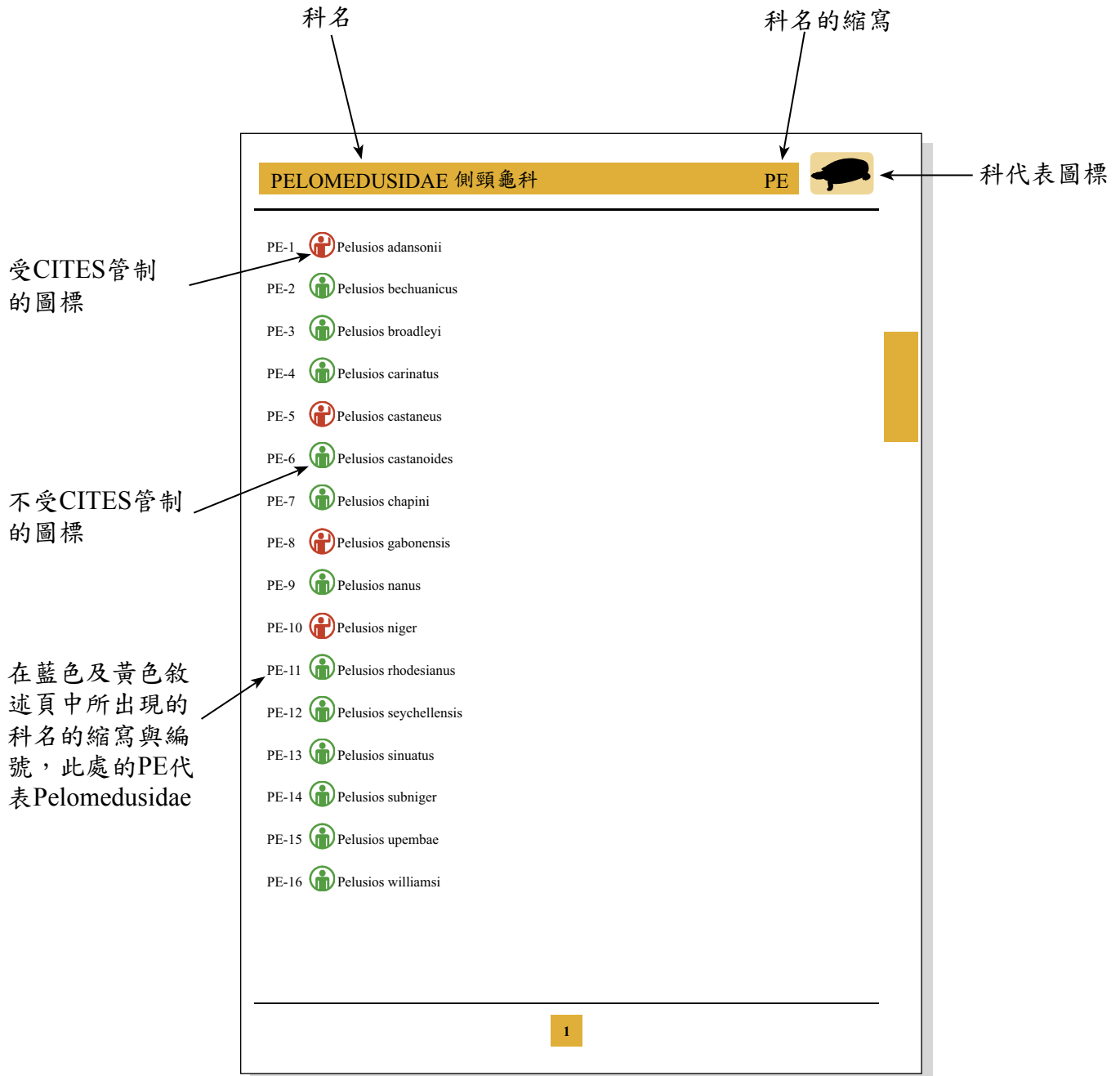

如何使用本圖鑑

附錄A的內容

附錄A提供本圖鑑中曾說明物種的學名、中、英文名的對照表，其排列是依學名的字母順序而成。

附錄A

學名	英文名	中文名
<i>Acanthochelys pallidipectoris</i>	Chaco Side-necked Turtle	加哥側頸龜
<i>Acanthochelys radiolata</i>	Brazilian Radiolated Swamp Turtle	巴西放射側頸龜
<i>Acanthochelys spixii</i>	Spiny-neck Turtle	棘頸側頸龜
<i>Amyda cartilaginea</i>	Asiatic Softshell Turtle	亞洲鱉
<i>Annamemys annamensis</i>	Annam Leaf Turtle	安南龜
<i>Apalone ferox</i>	Florida Softshell Turtle	佛羅里達鱉
<i>Apalone mutica</i>	Smooth Softshell Turtle	滑背鱉
<i>Apalone spinifera ater</i>	Black Spiny Softshell Turtle	黑棘鱉
<i>Apalone spinifera spinifera</i>	Eastern Spiny Softshell Turtle	東方棘鱉
<i>Aspideretes gangeticus</i>	Indian Softshell Turtle	印度鱉 (恆河鱉)
<i>Aspideretes hurum</i>	Indian Peacock Softshell Turtle	印度孔雀鱉
<i>Aspideretes leithii</i>	Leith's Softshell Turtle	來氏鱉
<i>Aspideretes nigricans</i>	Black Softshell Turtle	黑鱉
<i>Batagur baska</i>	Batagur	潮龜 (巴達庫爾龜)
<i>Callagur borneoensis</i>	Painted Terrapin	婆羅洲彩龜
<i>Caretta caretta</i>	Loggerhead	赤蠵龜
<i>Carettochelys insculpta</i>	Pig-nose Turtle	豬鼻龜
<i>Chelonia agassizii</i>	Pacific Green Turtle	黑海龜

本圖鑑的物種學名與英文名參考自：

John B. Iverson, Earlham College. 1992. *A Revised Checklist with Distribution Maps of the Turtles of the World*. Privately Printed. Richmond, Indiana, USA;

World Conservation Monitoring Centre. 1996. *Checklist of CITES Species. Lista de las especies CITES. Liste des espèces CITES*. First edition. Cambridge, UK;

現行龜類中文名稱有所歧異，本圖鑑附錄A及C採用常用或並列中文名稱。

如何使用本圖鑑

附錄B的內容

附錄B為依物種英文名字母順序所編之對照索引表，其中含有物種的學名、科名縮寫、管制狀態及所在的頁碼。

字母索引表包括：

- 一本圖鑑的說明的物種學名（附錄A）
- 圖鑑中所有物種在國際貿易中最常使用的俗名

附錄B

名稱	學名	管制狀態	科名	藍色 敘述頁	黃色 敘述頁	橘色 敘述頁
Abingdon Island Tortoise	<i>Geochelone nigra abingdonii</i>	C, TE			2*	
Acanthochelys pallidipectoris	<i>Acanthochelys pallidipectoris</i>	N.C, CI			26	
Acanthochelys radiolata	<i>Acanthochelys radiolata</i>	N.C, CI			26	
Acanthochelys spixii	<i>Acanthochelys spixii</i>	N.C, CI			26	
Acanthochelys Spp.	<i>Acanthochelys Spp.</i>	N.C, CI			26	
Acinisside	<i>Pyxis planicauda</i>	C, TE			18	
Acinixys planicauda	<i>Pyxis planicauda</i>	C, TE			18	
Adanson's Mud Turtle	<i>Pelusios adansonii</i>	C, PE-1			30*	1
Aegyptische Landschildkröte	<i>Testudo kleinmanni</i>	C, TE			17	
Afghan Tortoise	<i>Testudo horsfieldii</i>	C, TE			17	
African Black Terrapin	<i>Pelusios niger</i>	C, PE-10			30*	1
African bungoma	<i>Cyclanorbis senegalensis</i>	N.C, TR		7		
African Dwarf Mud Turtle	<i>Pelusios nanus</i>	N.C, PE-9			30*	1
African Flap-shell Turtle(s)	<i>Cyclanorbis Spp.</i>	N.C, TR		7		
African Forest Tortoise(s)	<i>Kinixys Spp.</i>	C, TE		5		
African Forest Turtle	<i>Pelusios gabonensis</i>	C, PE-8			30*	1
African Helmeted Turtle	<i>Pelomedusa subrufa</i>	C, PE			30	
African Hinged Terrapin(s)	<i>Pelusios Spp.</i>	N.C-C, PE			30	1
African Keeled Mud Turtle	<i>Pelusios carinatus</i>	N.C, PE-4			30*	1
African Mud Turtle	<i>Pelusios castaneus</i>	C, PE-5			30	1
African Mud Turtle	<i>Pelusios subniger</i>	C, PE-14			30*	1

N.C未受CITES所管制的物種 

C受CITES所管制的物種 
(依1997年開始生效名錄而定)

PE-14該物種所屬科名縮寫（*Pelomedusidae*）及其編號。此物種的圖示出現在黃色敘述頁，且必須請相關專家協助鑑定。

參閱第 30 頁上的圖示

* 表示物種於本圖鑑中並未有至種的階層或亞種說明。

附註：
Pelusios subniger
↑ ↑
屬名 種名

如何使用本圖鑑

圖標



受CITES管制



不受CITES管制



扣留並請專家鑑定



指辨識的重要特徵



下方有需要辨識的重要特徵

?

「如何使用本圖鑑」部分



檢索頁部分



最容易辨識的物種章節



需較仔細比對的物種章節



需請求專家協助鑑定物種名錄

A

附錄A本圖鑑中物種的學名及中、英文名對照表

B

附錄B本圖鑑中物種的學名及中、英文名的索引頁碼

C

附錄C為常見藥用龜板來源物種表



食品



皮革製品



背甲加工製品



蛋



珠寶



其他產製品



油脂



特殊特徵



黑線=30公分（一呎）



藍線=5公分（2吋）

?

如何使用本圖鑑

尺寸大小

要了解標本的大小，可利用背甲或腹甲圖示旁的黑線（30公分，1呎）或藍線（5公分，2吋）的比例尺。如果圖示旁有黑線比例尺出現，在辨識標本旁放置30公分（1呎）的直尺。如果出現藍色比例尺時，則可放置5公分（2吋）的直尺。由圖上與直尺顯示的長度相比對就可了解該標本的大小。

例如：

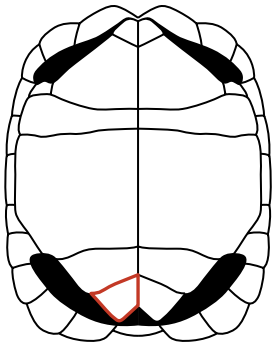

Geochelone nigra
約130公分（4.2呎）

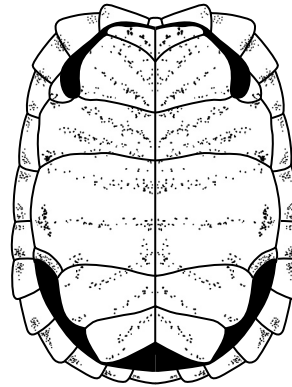
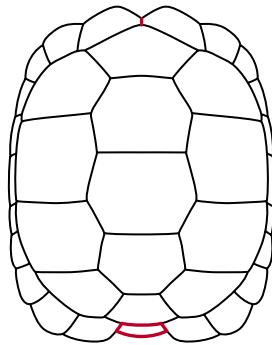

Homopus signatus
約10公分（4吋）

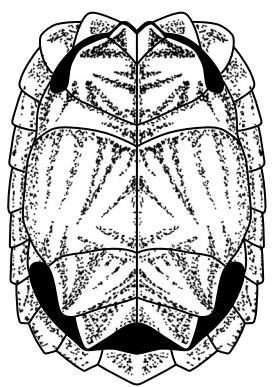
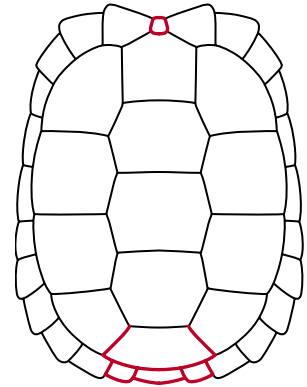

Geochelone elegans
約28公分（11吋）

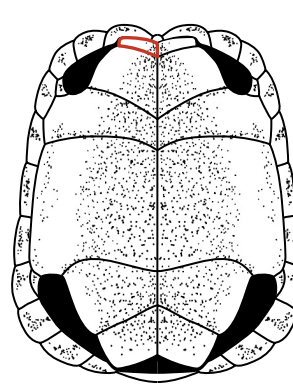
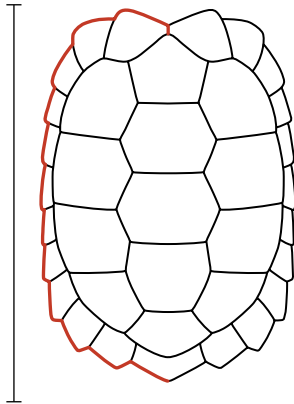

Homopus areolatus
從約10公分（4吋）至約30公分（1呎）

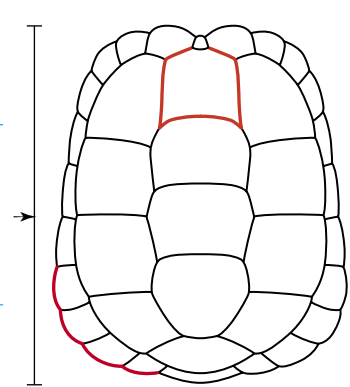

在所有情況下，比例尺只顯示約略大小，而非絕對的測量值。

Key pages 綠色檢索頁

說明如何進行辨識的程
序，包括檢索頁。



檢索頁使用的形態特徵

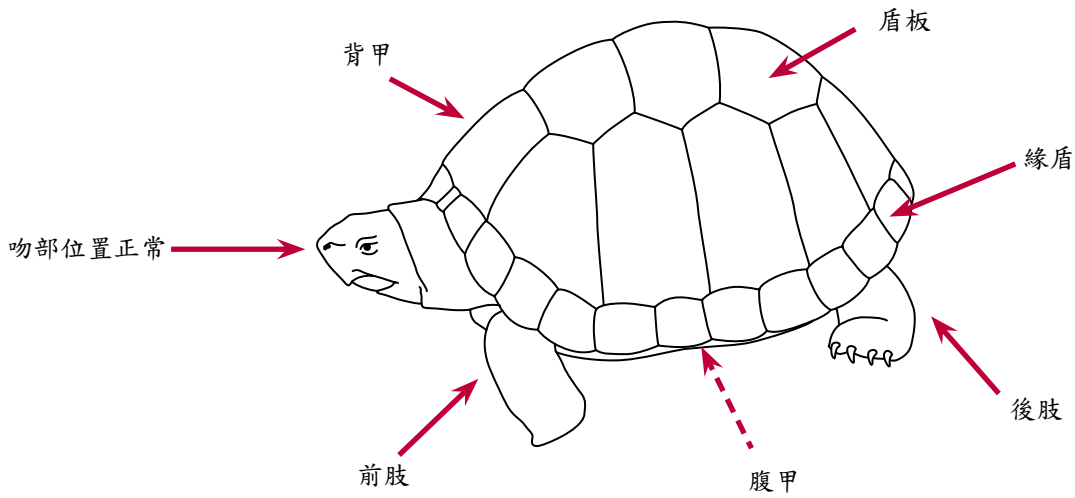
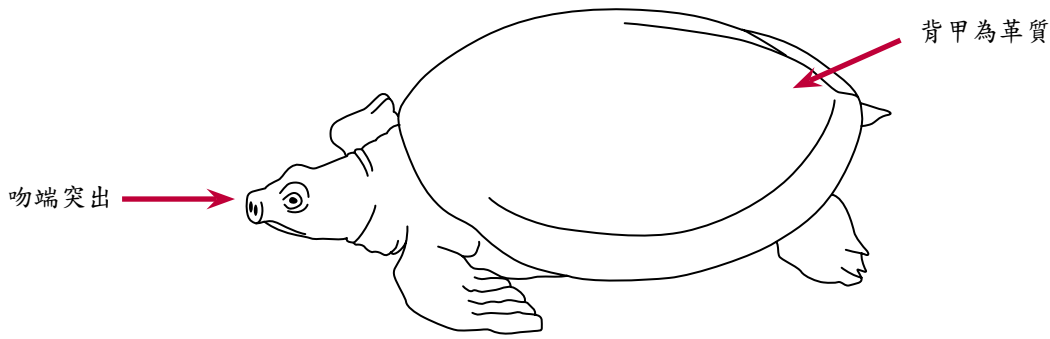

船槽狀的前肢

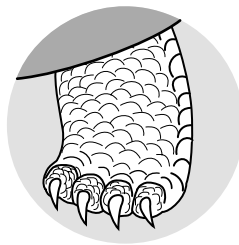

後肢似大象四肢呈圓柱狀，具有爪

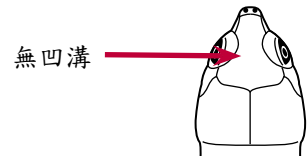
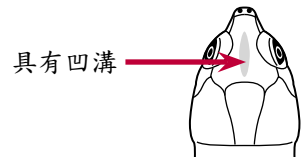

四肢趾間有蹼，具有爪

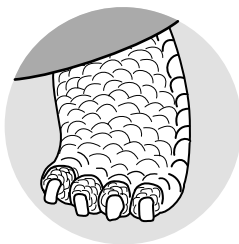

後肢似大象四肢呈圓柱狀，爪子平整

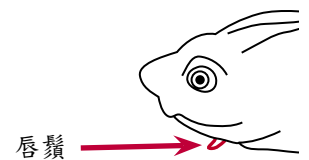



背甲

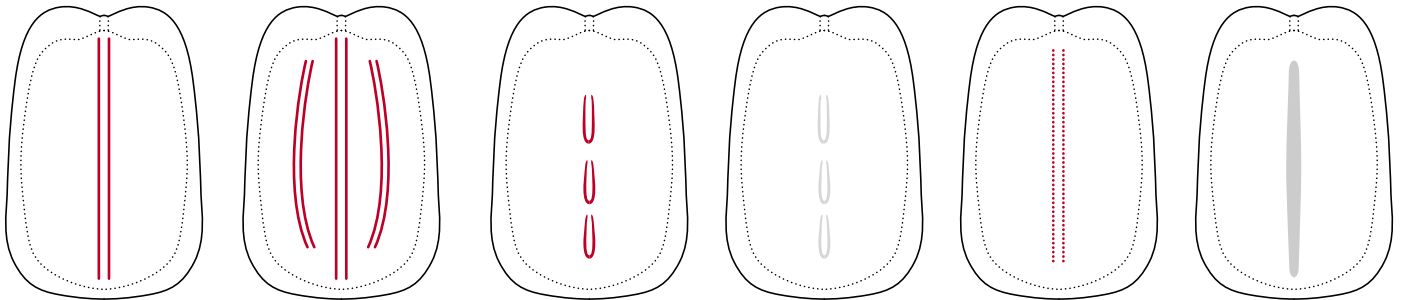
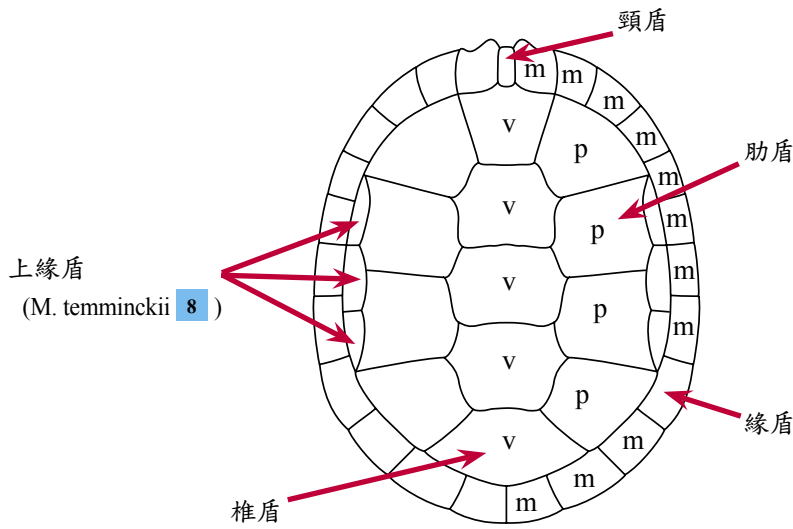

背甲具有一或三道稜脊

節狀稜脊

節狀稜脊微凸

稜脊微凸

凹溝

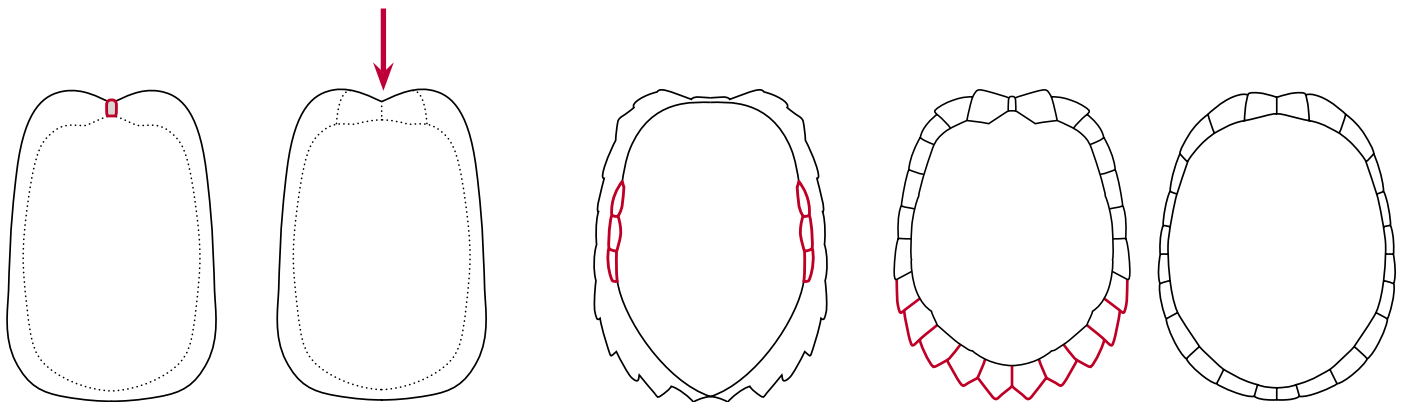

背甲具有頸盾

背甲不具頸盾

背甲具有上緣盾

背甲後緣呈鋸齒狀 或 不呈鋸齒狀





背甲

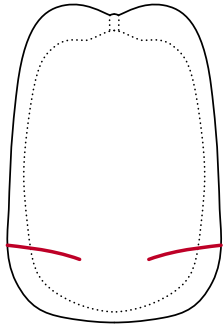

背甲後緣有韌帶構造

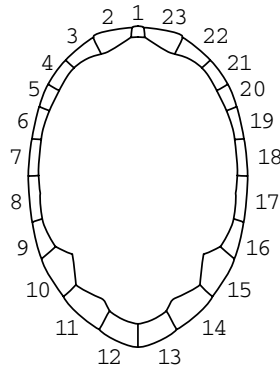

緣盾數為23塊

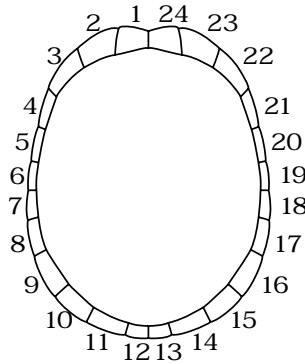

緣盾數為24-25塊 (及其他)

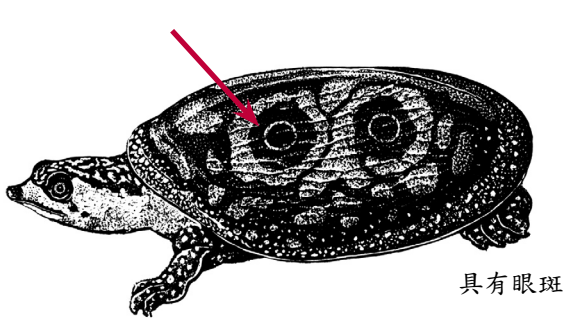
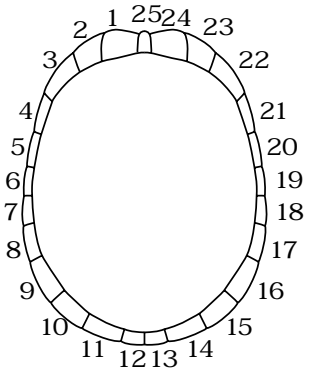

具有眼斑

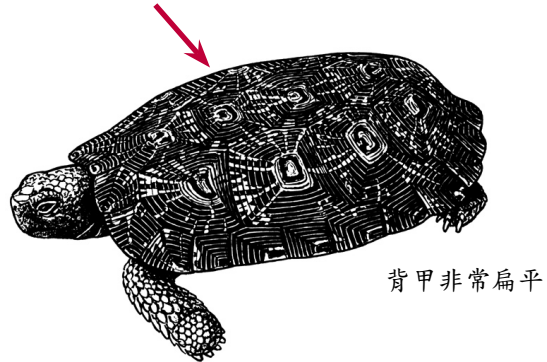

背甲非常扁平

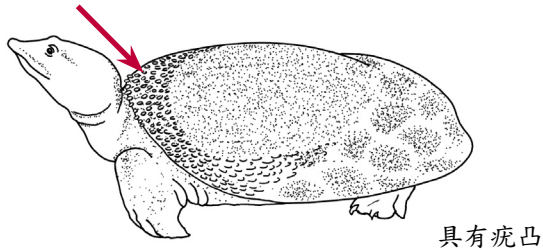

具有疣凸

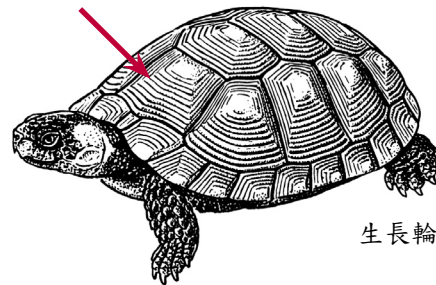

生長輪

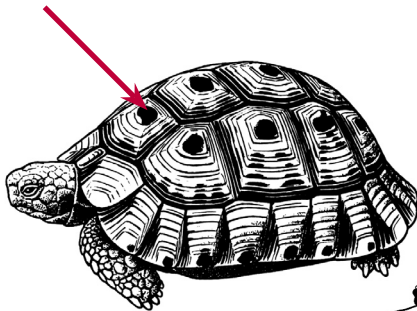

背甲上具塊狀花紋

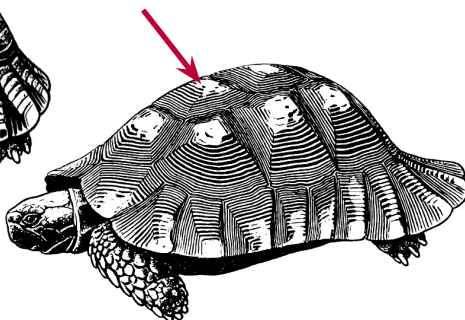

背甲上具星狀花紋





腹甲

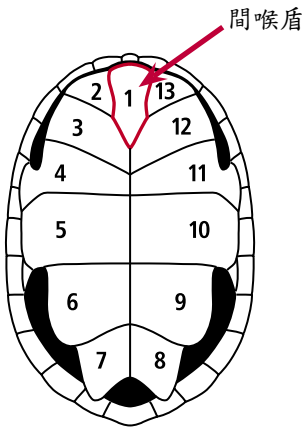
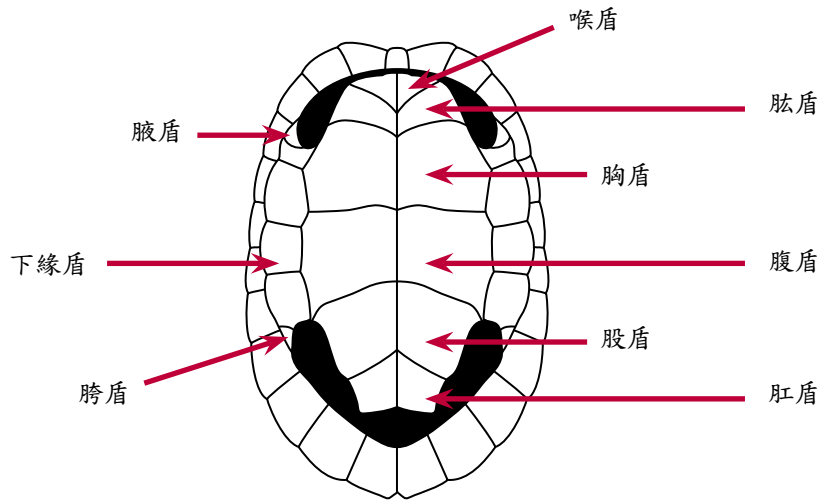

腹甲盾板數13塊

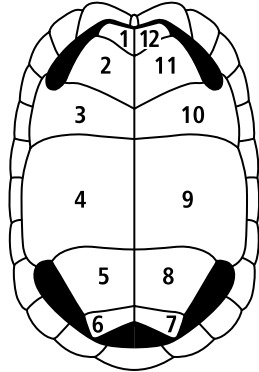

腹甲盾板數12塊

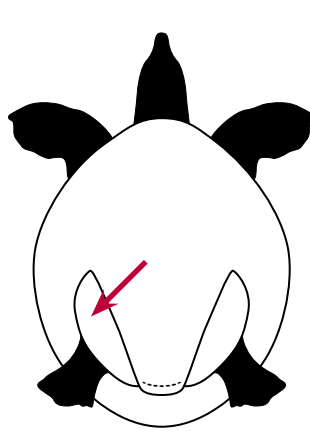

腹甲具有胯瓣

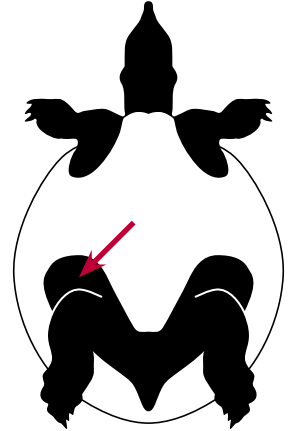

腹甲不具胯瓣

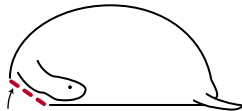
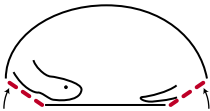

腹甲具一或二處韌帶構造

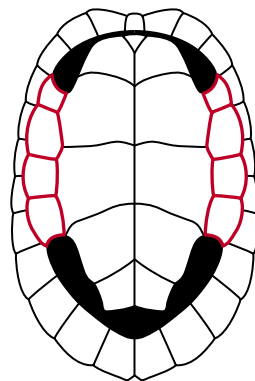
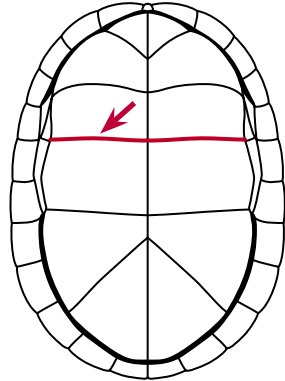
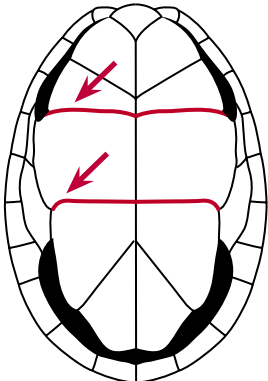

具有下緣盾

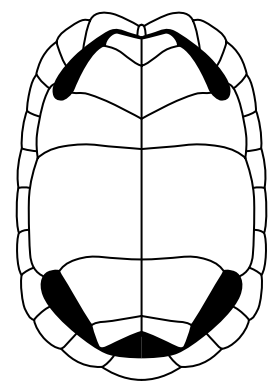

不具下緣盾



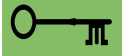

四肢呈船櫓狀，具一、二爪或無爪

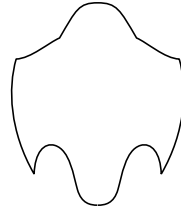
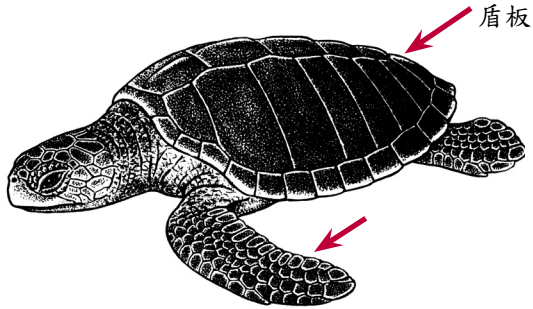

Cheloniidae
蠍龜科

▶ 2

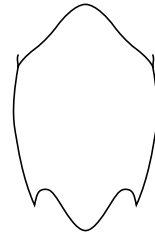
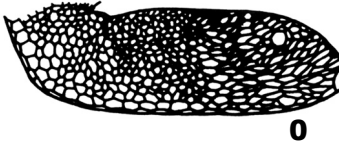

Dermochelyidae
革龜科

▶ 4

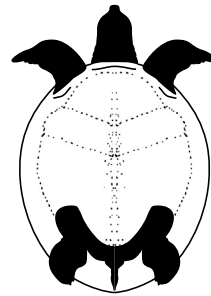
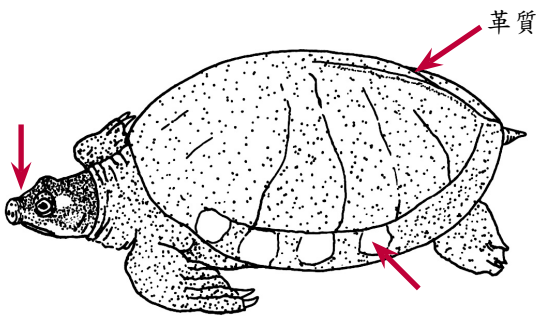

Carettochelyidae
豬鼻龜科

▶ 4

四肢似大象四肢的圓柱形，趾間無蹼

背甲非常扁平

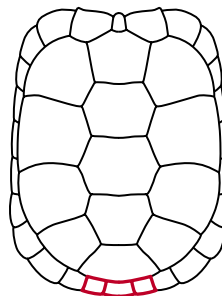
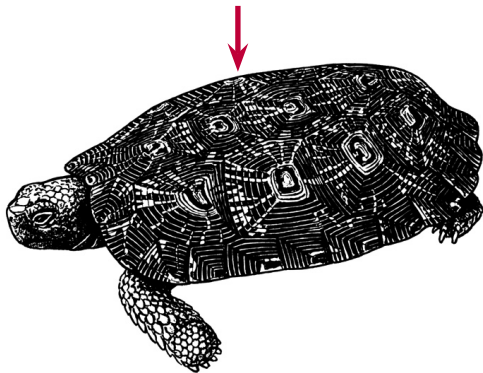

Malacochersus tornieri

▶ 7



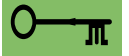

背甲隆起

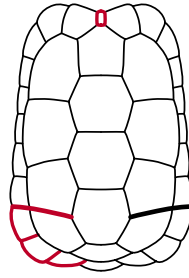
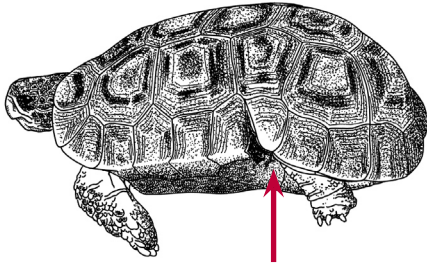

背甲上具有韌帶構造

Testudinidae
象龜科

▶ 5

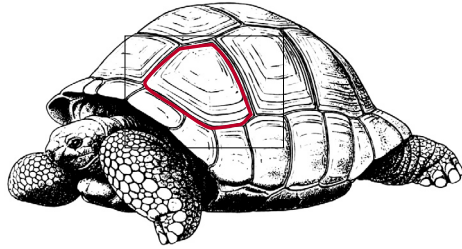

背甲花色一致

Testudinidae
象龜科

▶ 2

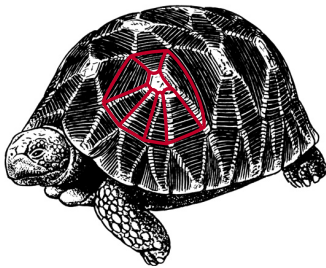

背上具有星狀花紋

Testudinidae
象龜科

▶ 5

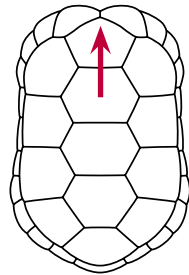
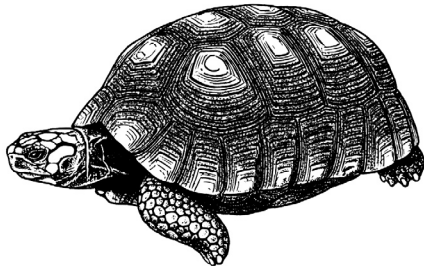

背甲上具有斑點，無頸盾

Testudinidae
象龜科

▶ 9

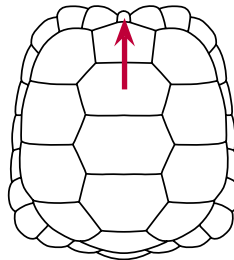
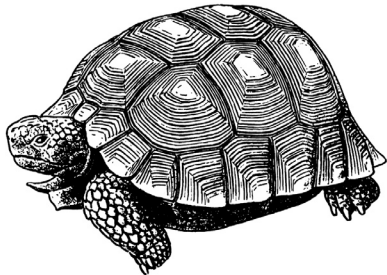

背甲具有頸盾，有黃、橘或紅色斑點

Testudinidae
象龜科

▶ 12

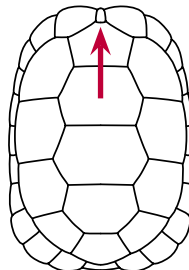
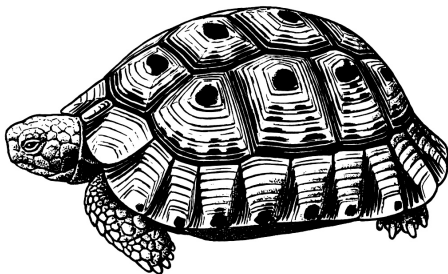

背甲具有頸盾，有綜或黑色斑點（或斑紋）

Testudinidae
象龜科

▶ 16



四肢趾間有蹼，背甲扁平



背甲為革質構造

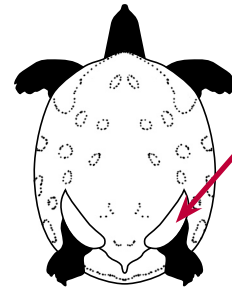
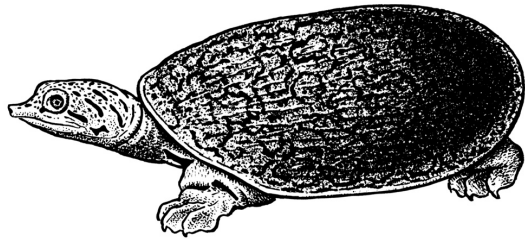
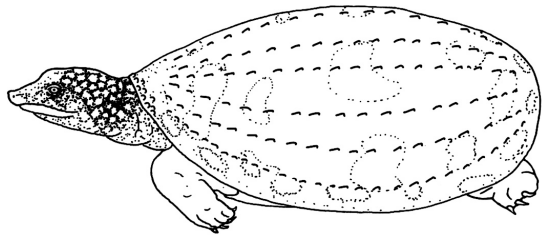

具有膀胱

Trionychidae
鱉科

6



不具膀胱

Trionychidae
鱉科

21



腹甲盾板數為13塊

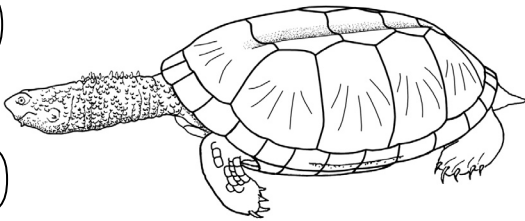
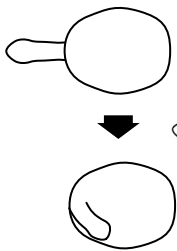

具有頸盾

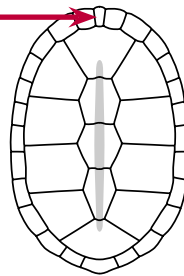

具有間喉盾

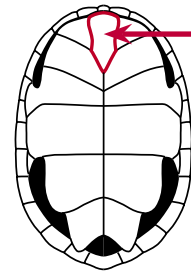

Chelidae
蛇頸龜科

26

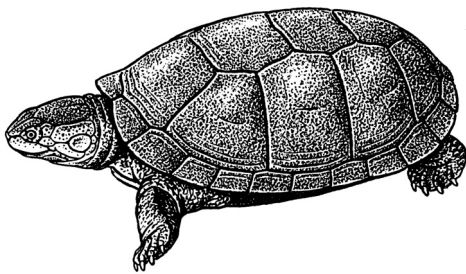
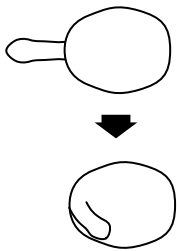

不具頸盾

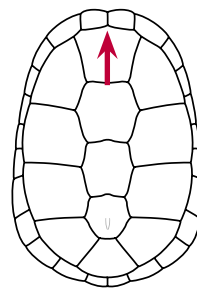

韌帶構造

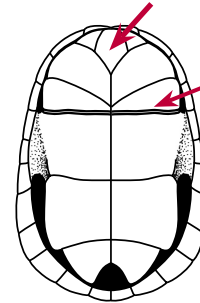

Pelomedusidae
側頸龜科

30

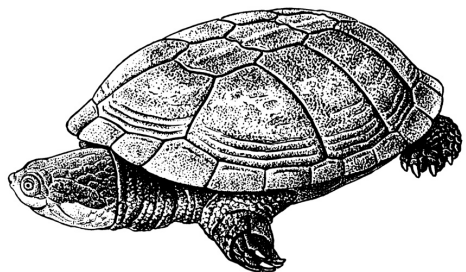

不具頸盾

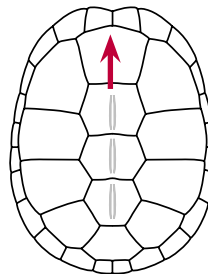

不具韌帶構造

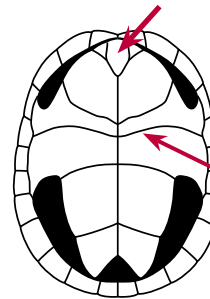

四肢趾間有蹼，背甲扁平

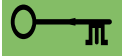

具有下列腹甲型式的物種

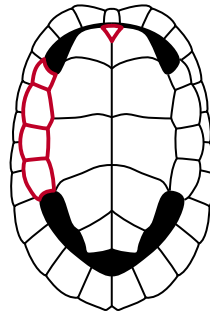
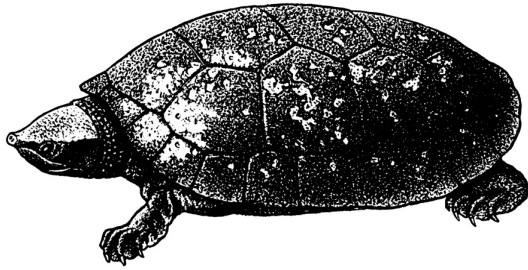

Dermatemydidae
中美洲河龜科

▶ 39

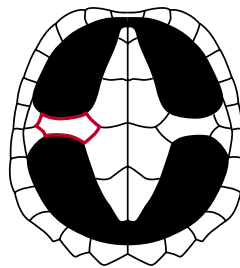
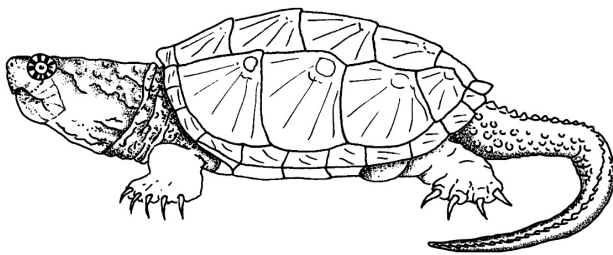

Chelydridae
鱧龜科

▶ 8

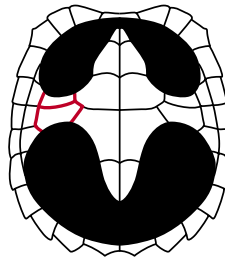
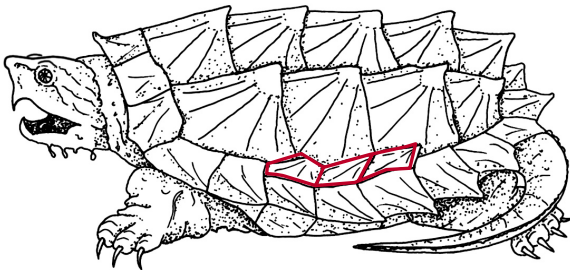

Platysternidae
平胸龜科

▶ 9



四肢趾間有蹼，背甲扁平



緣盾數為23塊

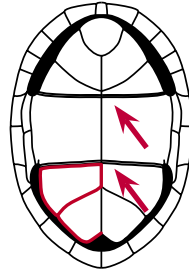
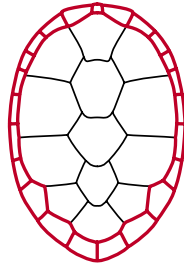
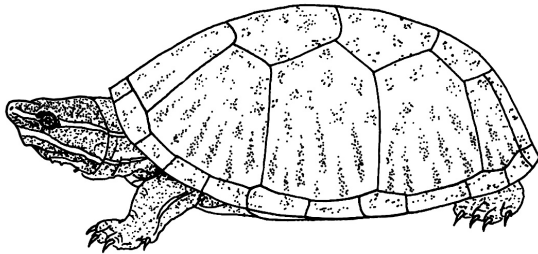
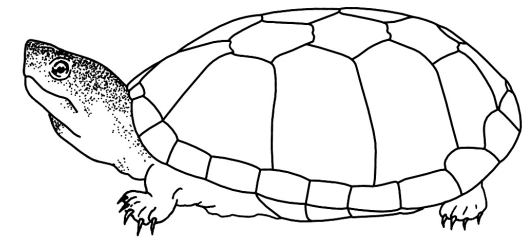

具有二處
韌帶構造

Kinosternidae
麝龜科

▶ 34

或

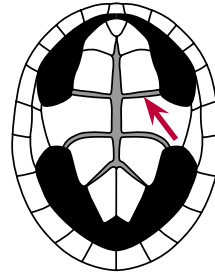

具有一處韌
帶構造

Kinosternidae
麝龜科

▶ 35



腹甲上具有一處韌帶構造

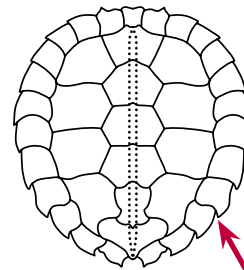
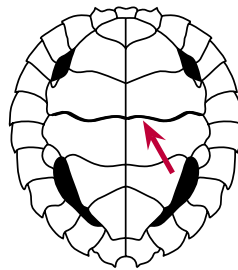
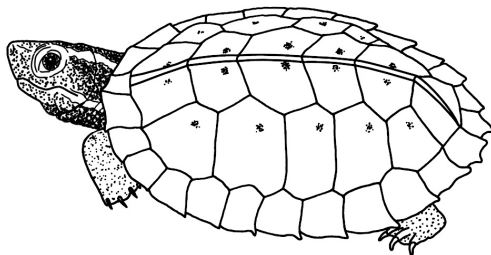

緣盾呈鋸齒狀突起

Emydidae
澤龜科

▶ 40

具有或無稜脊

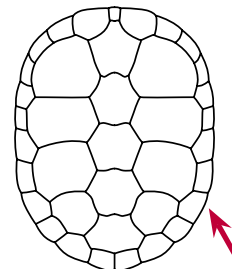
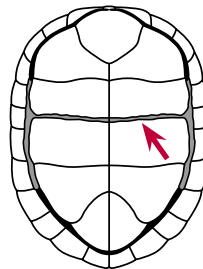
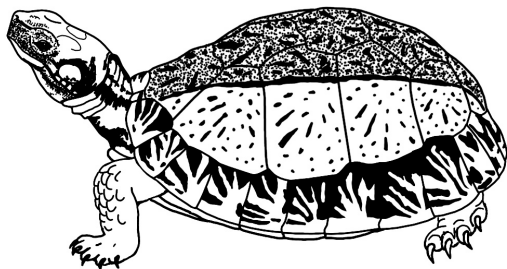

緣盾無鋸齒狀突起

Emydidae
澤龜科

▶ 41

具有或無稜脊



四肢趾間有蹼，背甲扁平

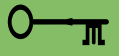

背甲不具稜脊

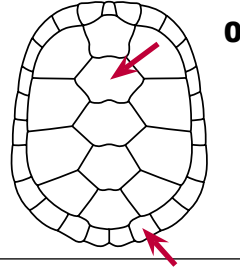
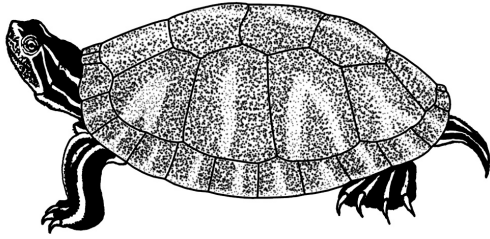

緣盾有鋸齒狀突起

Emydidae
澤龜科

▶ 46

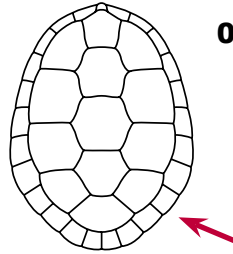
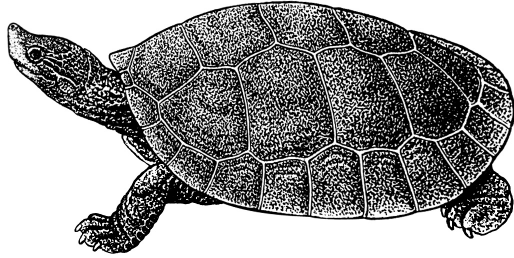

緣盾不具鋸齒狀突起

Emydidae
澤龜科

▶ 47

背甲具有一道稜脊

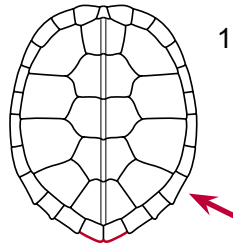
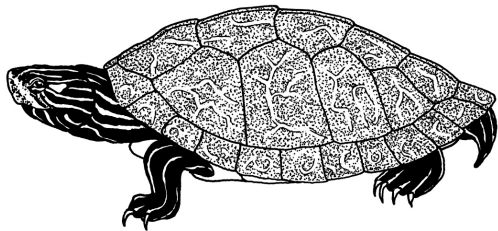

緣盾有鋸齒狀突起

Emydidae
澤龜科

▶ 51

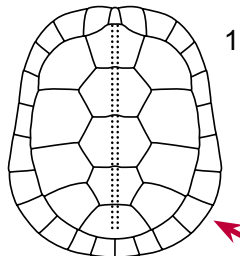
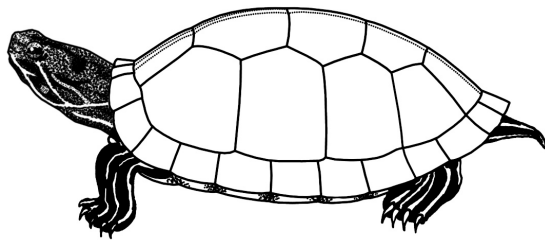

緣盾不具鋸齒狀突起

Emydidae
澤龜科

▶ 56

背甲具有三道稜脊

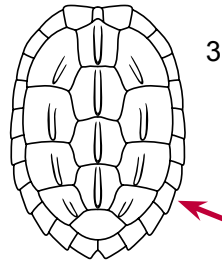
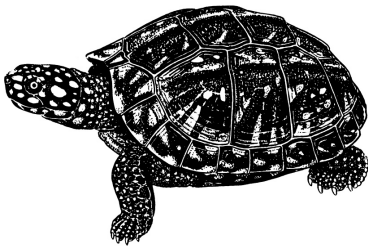

緣盾有鋸齒狀突起

Emydidae
澤龜科

▶ 60

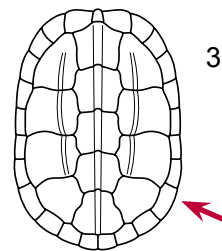
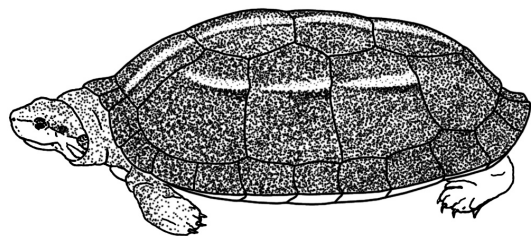

緣盾不具鋸齒狀突起

Emydidae
澤龜科

▶ 61



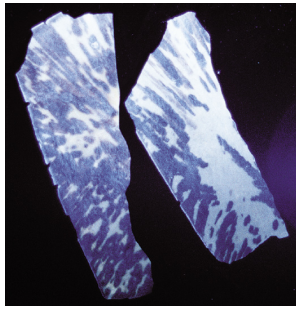

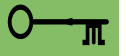

腹甲特徵辨識檢索

腹甲柔軟，不具盾板



Trionychidae 鱉科

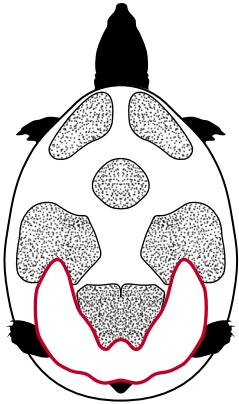

Lissemys punctata 6

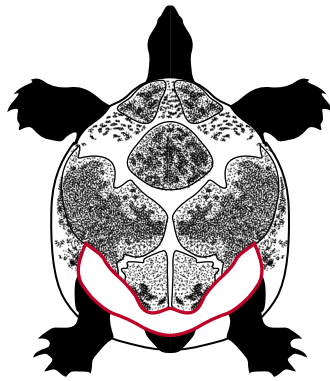

Cycloderma aubryi 6

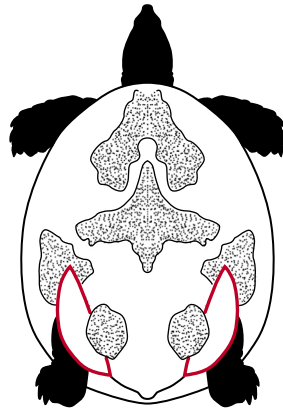

Cyclanorbis senegalensis 7

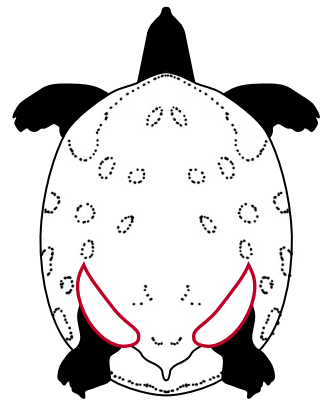

Cyclanorbis elegans 7



Trionychidae 鱉科

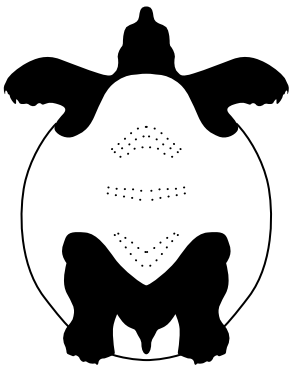

Aspideretes hurum 21



Aspideretes gangeticus 21

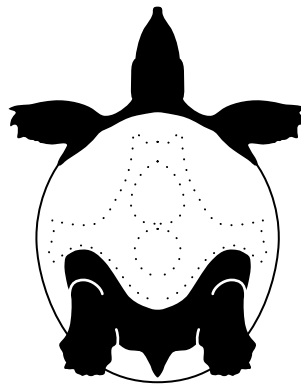

Rafetus euphraticus 22

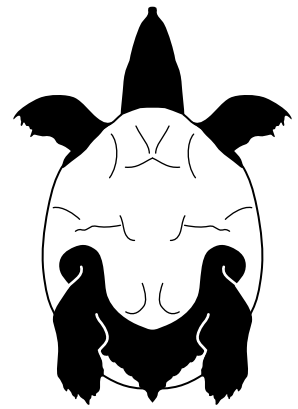

Pelodiscus sinensis 22

Nilssonina formosa

Aspideretes leithii

Trionychidae 鱉科

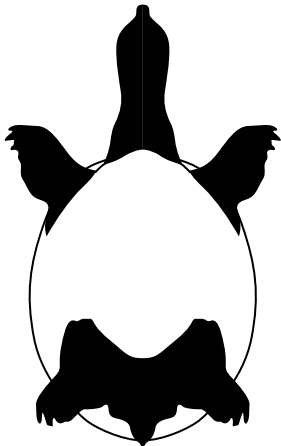

Aspideretes nigricans 22

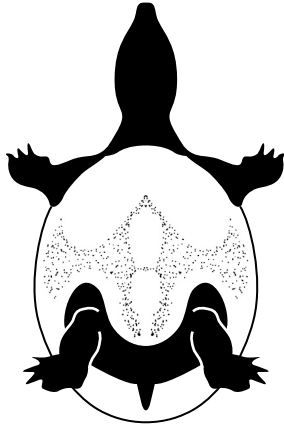

Palea steindachneri 23

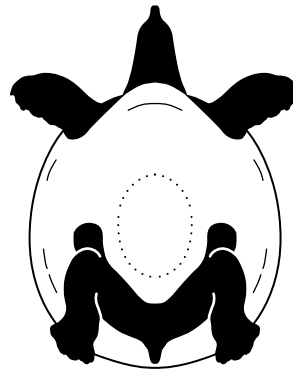

Trionyx triunguis 23

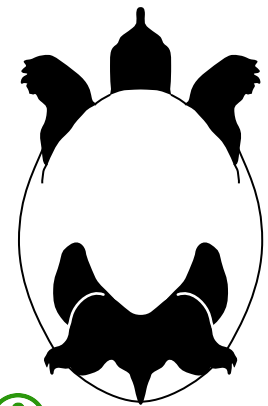

Amyda cartilaginea 23

Nilssonina formosa





Trionychidae 鱉科



Apalone spinifera spinifera 24

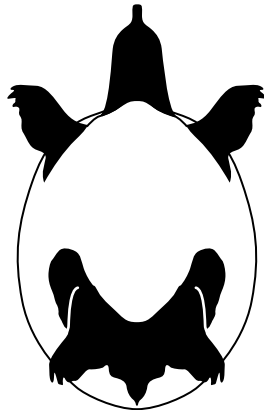

Dogania subplana 24

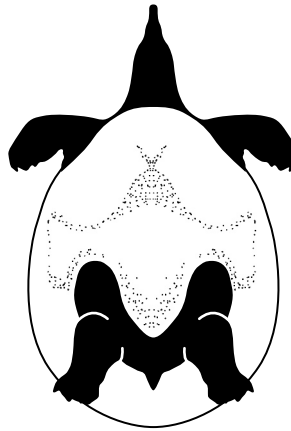

Apalone ferox 24

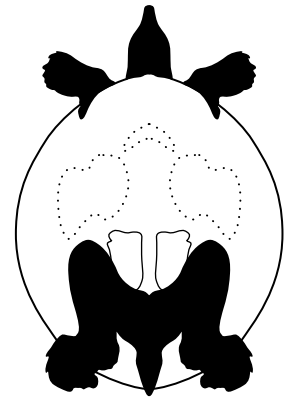

Apalone mutica 25

Apalone spinifera ater

Trionychidae 鱉科

Carettochelyidae

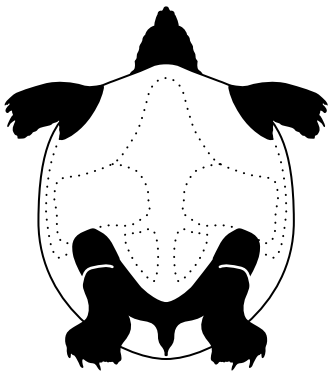

Chitra indica 25

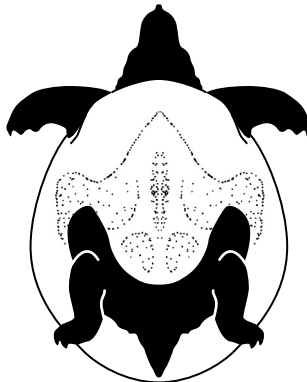

Pelochelys bibroni 25

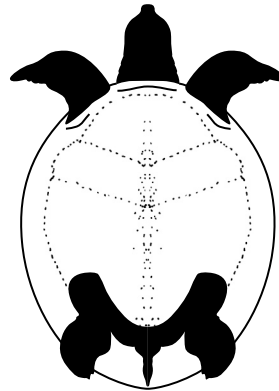

Carettochelys insculpta 4

Dermochelyidae 革龜科

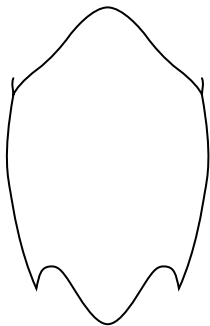

Dermochelys coriacea 4



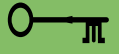

Cheloniidae 蠍龜科

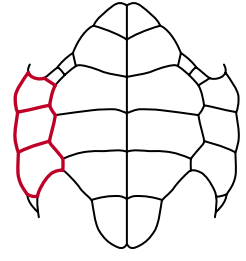
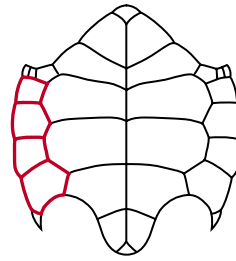
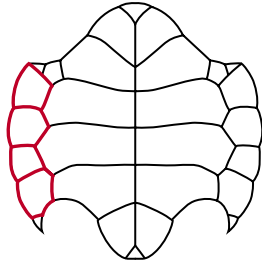
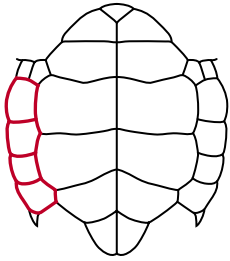

Eretmochelys imbricata 2

Natator depressa 2

Chelonia mydas

Chelonia agassizii 2

Caretta caretta 3

Cheloniidae 蠍龜科

Chelydridae 鱷龜科

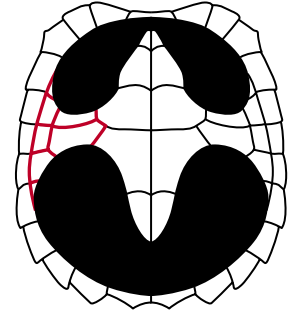
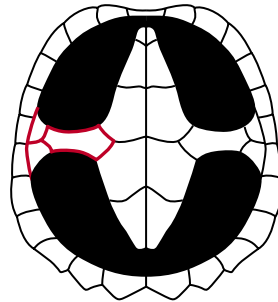
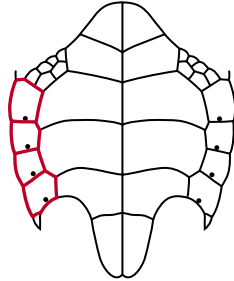
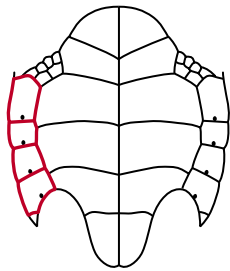

Lepidochelys kempii 3

Lepidochelys olivacea 3

Chelydra serpentina 8

Macrolemys temminckii 8

Platysternidae 平胸龜科

Dermatemydidae 中美洲河龜科

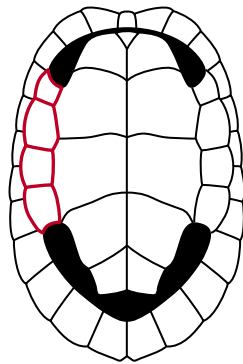
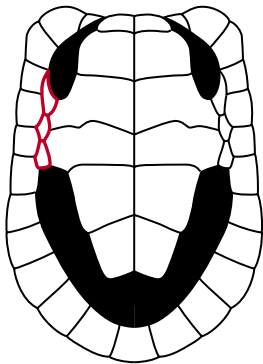

Platysternon megacephalum 9

Dermatemydidae 39



Chelidae 蛇頸龜科

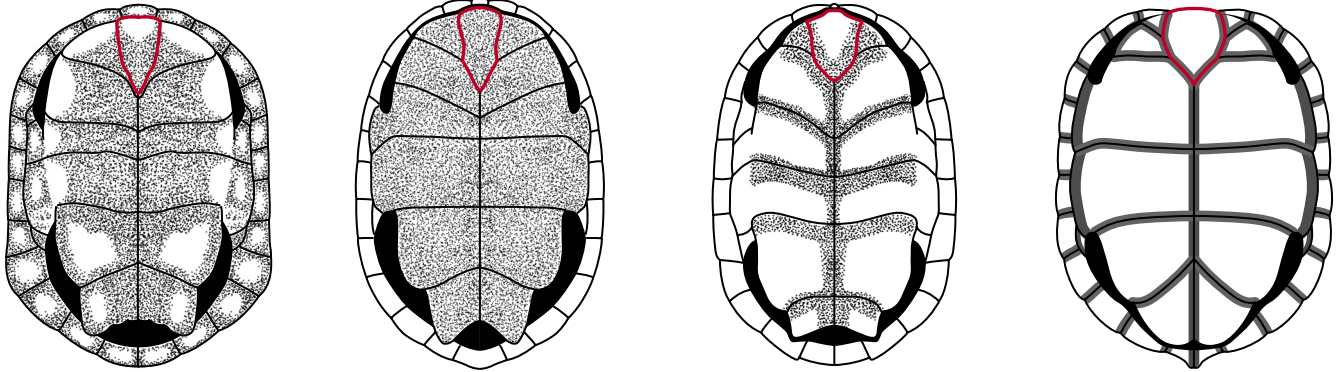

- Acanthochelys pallidipectoris* 26
 Acanthochelys spixii 26
 Acanthochelys radiolata 26
 Pseudemydura umbrina 27



Chelidae 蛇頸龜科

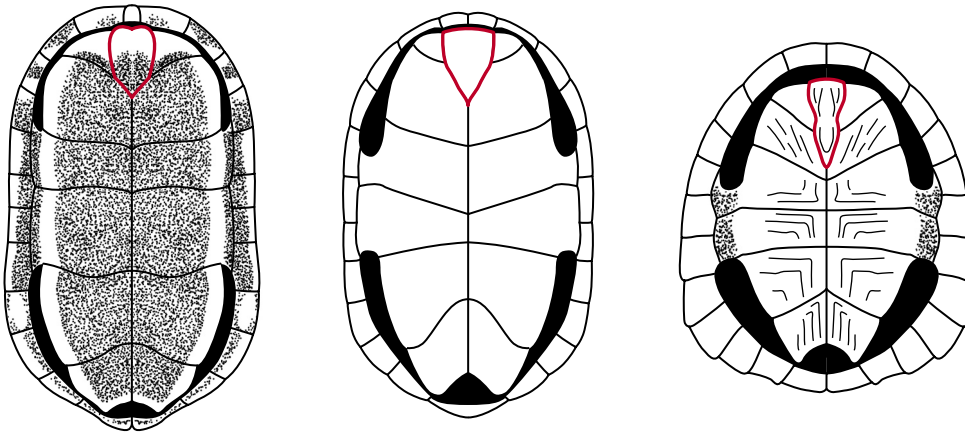

- Platemys platycephala* 27
 Hydromedusa maximiliani 28
 Hydromedusa tectifera 28

Chelidae 蛇頸龜科

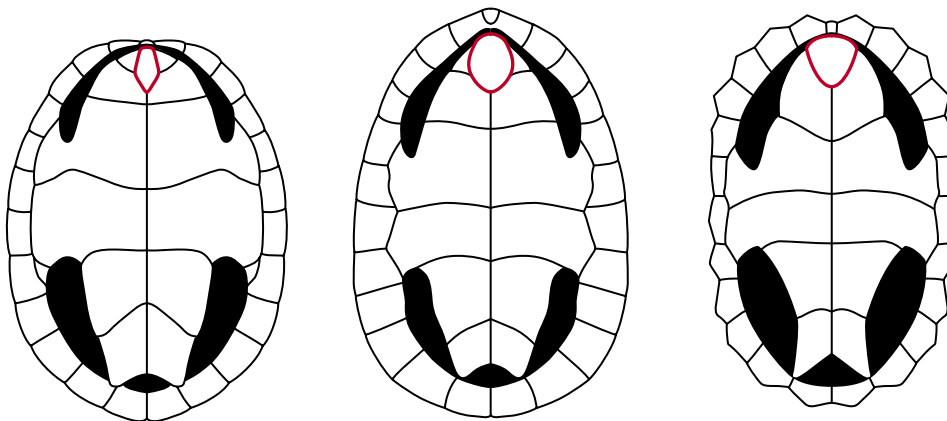

- Elseya novaeguineae* 29
 Emydura subglobosa 29
 Chelus fimbriata 29





Pelomedusidae

側頸龜科

具有一處
韌帶構造

幼龜具有花紋

幼龜具有花紋

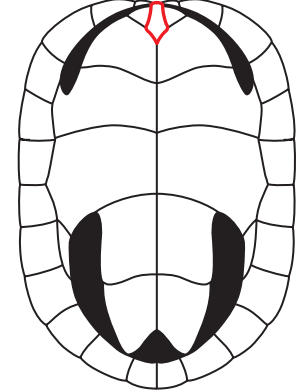
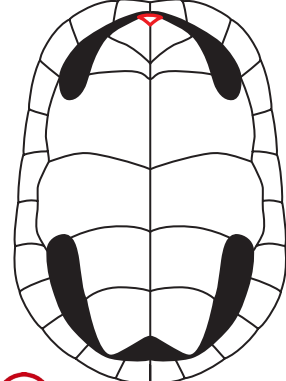
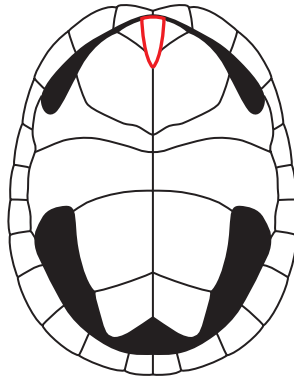
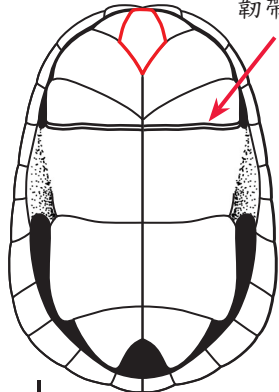

Spp. PE-1-5-8-10
其他 30

Pelomedusa subrufa 30

Erymnochelys madagascariensis 31

Peltocephalus dumerilianus 31



Pelomedusidae

頸龜科

1<2

1>2

1>2

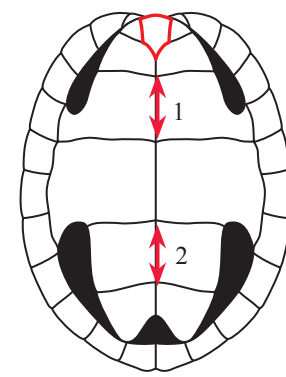
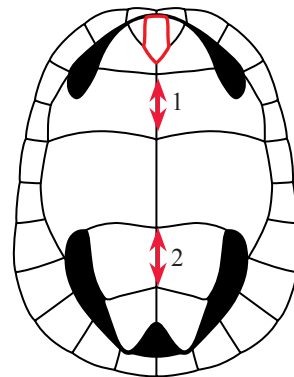
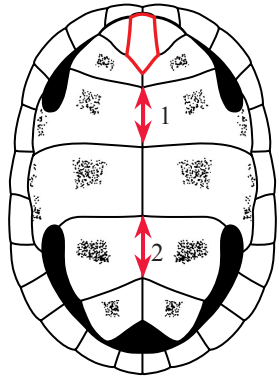

Podocnemis vogli 32

Podocnemis expansa 32

Podocnemis lewyana 32

Pelomedusidae

頸龜科

年齡較大個體具有黑色斑點

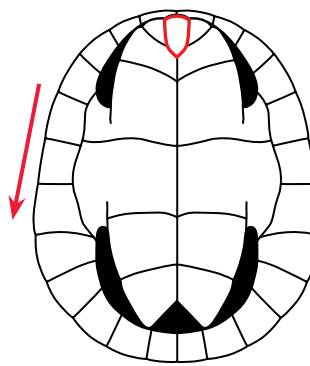
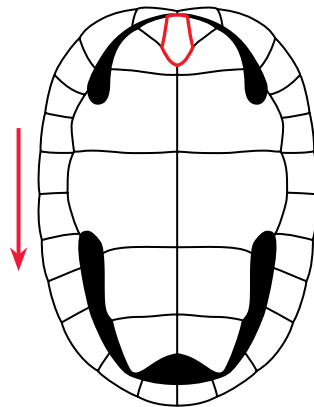
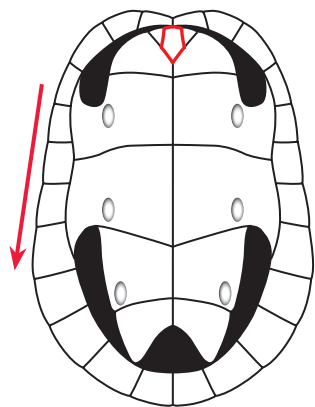

Podocnemis sextuberculata 33

Podocnemis unifilis 33

Podocnemis erythrocephala 33



Kinosternidae 麝龜科

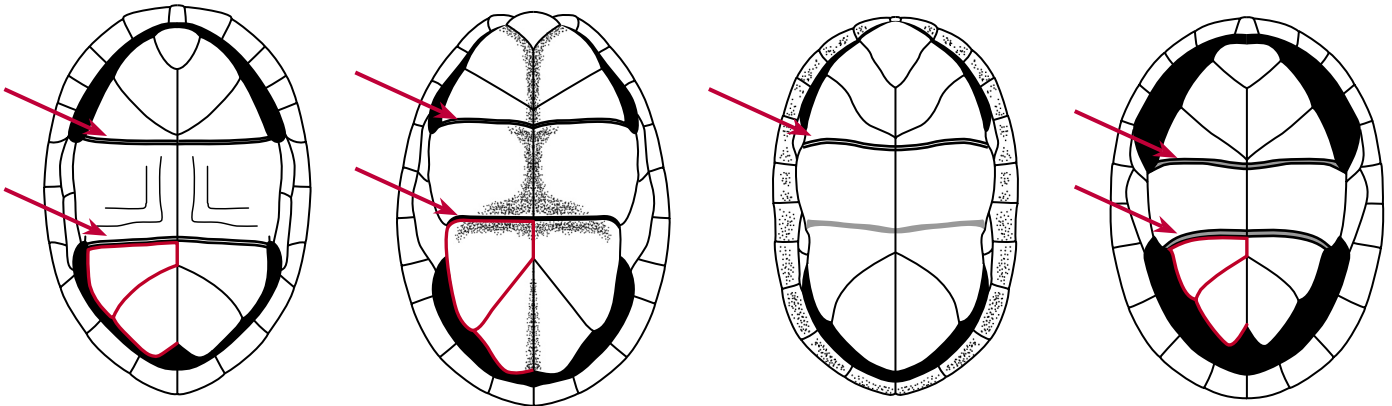

Kinosternon flavescens 34

Kinosternon baurii 34

Kinosternon leucostomum 34

Kinosternon subrubrum 35



Kinosternidae 麝龜科

個體花紋變異

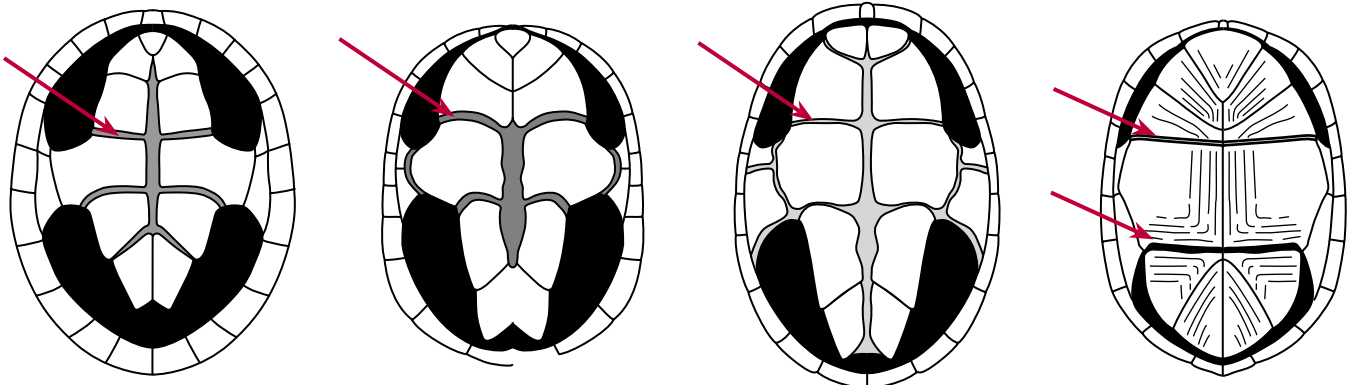

Sternotherus odoratus 35

Sternotherus minor 36

Sternotherus carinatus 36

Kinosternon acutum 37

Kinosternidae 麝龜科

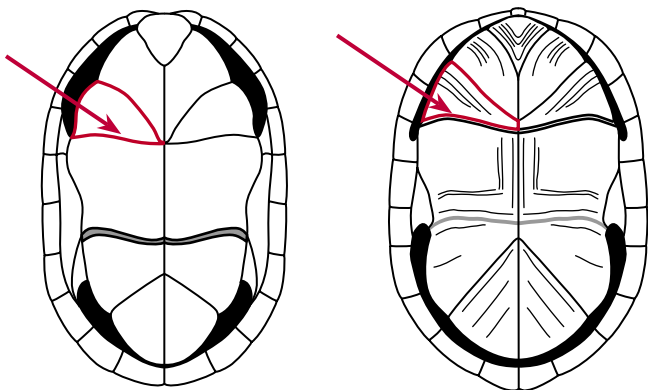

Kinosternon scorpioides
scorpioides 38

Kinosternon scorpioides
cruentatum 38





Testudinidae 象龜科

韌帶構造隨不同亞種而異

成體具有韌帶構造

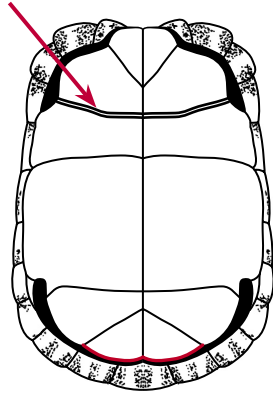

幼龜具有花紋



Pyxis arachnoides 7

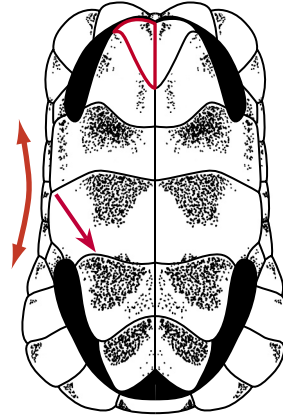

Testudo marginata 14

Testudinidae 象龜科

成體具有韌帶構造

成體具有韌帶構造 花紋隨個體變異

成體具有韌帶構造

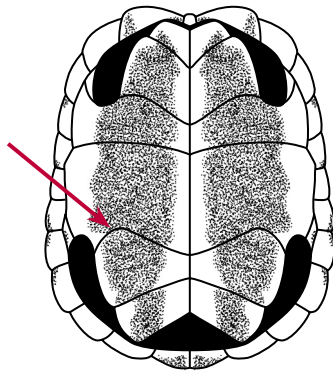

Testudo hermanni 16

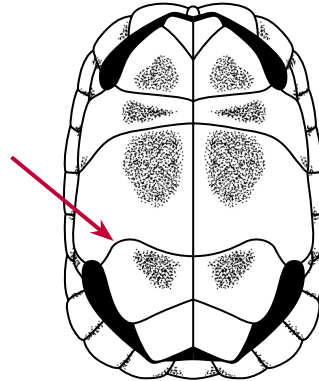

Testudo graeca 16

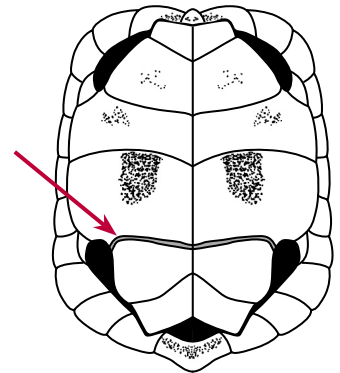

Testudo kleinmanni 17





Emydidae 澤龜科

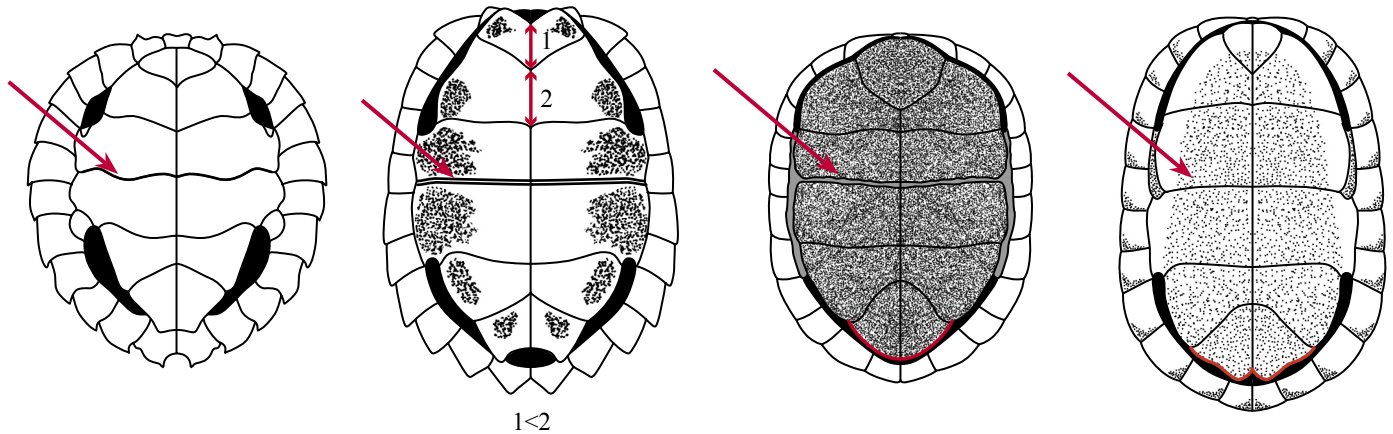

Notochelys platynota 40

Pyxidea mouhotii 40

Cuora galbinifrons 41

Cuora trifasciata 41



Emydidae 澤龜科

具韌帶 (幼龜無韌帶)

花紋隨個體變異

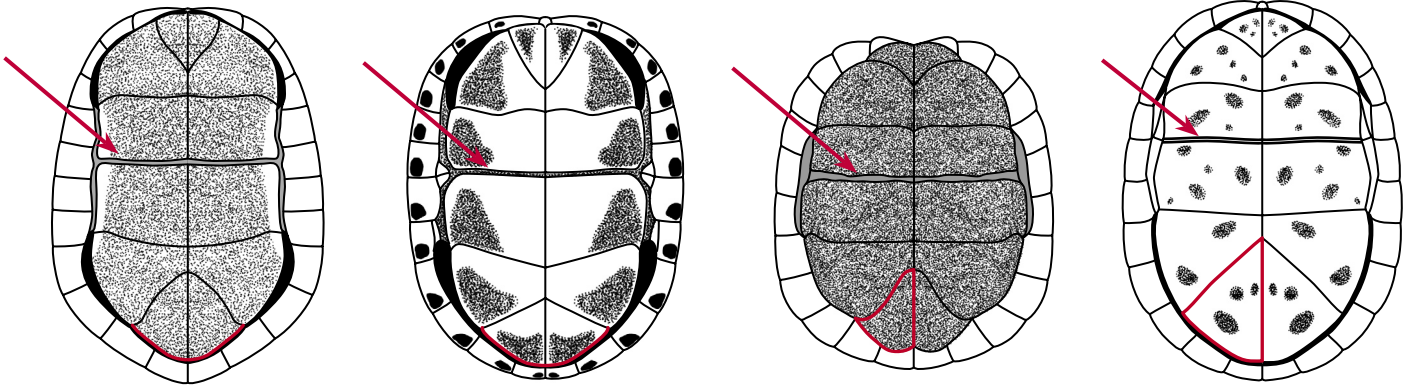

Cuora flavomarginata 42

Cuora amboinensis 42

Terrapene carolina 43

Terrapene coahuila 43

Emydidae 澤龜科

花紋隨個體變異

花紋隨個體變異

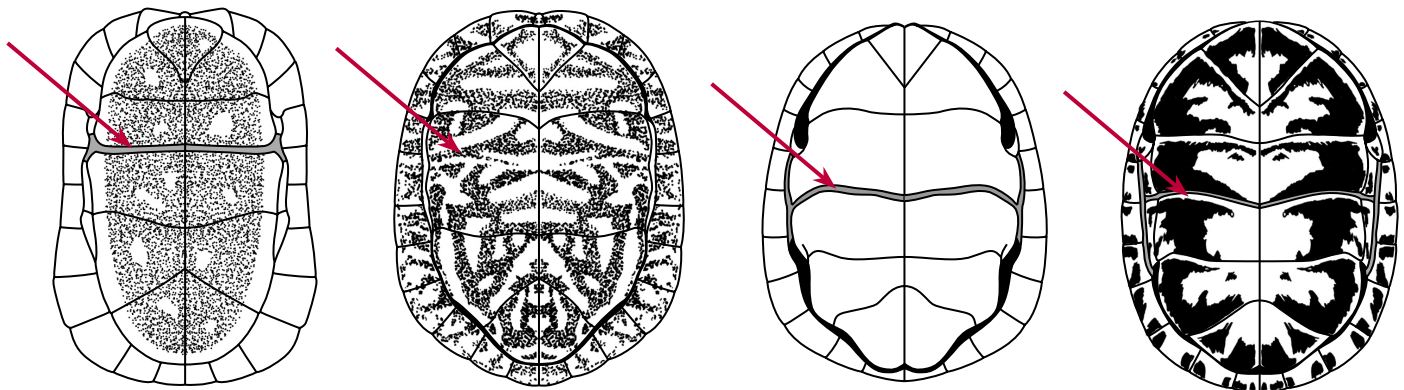

Terrapene nelsoni 44

Terrapene ornata 44

Emys orbicularis 45

Emydoidea blandingii 45

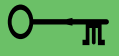

Testudinidae 象龜科

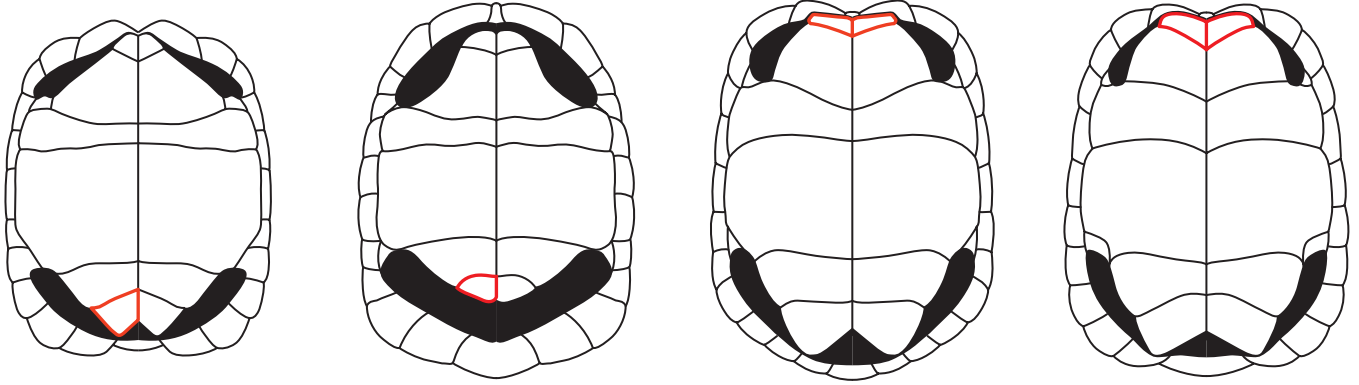

Geochelone nigra 2

Geochelone gigantea 2

Homopus boulengerii 3

Homopus femoralis 3

Testudinidae 象龜科

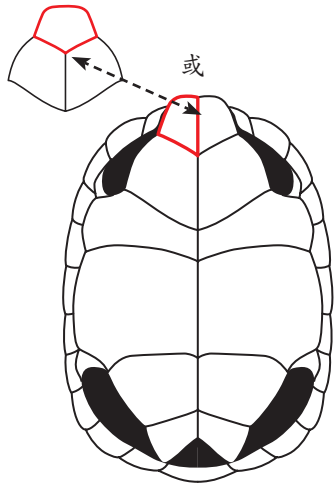

Geochelone sulcata 10

Gopherus polyphemus 12

Geochelone yniphora 13

Manouria impressa 18

Testudinidae 象龜科

Emydidae 澤龜科

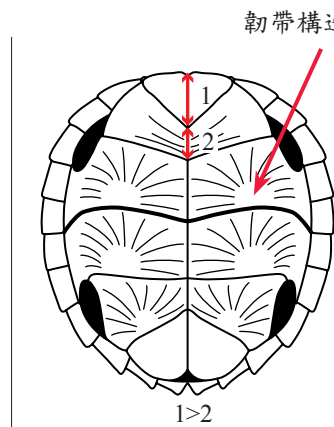
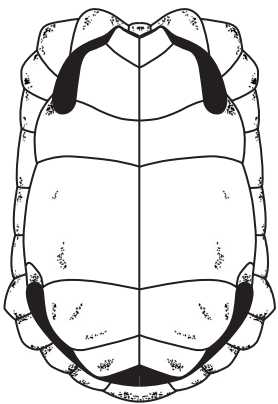

韌帶構造不明顯

1 > 2

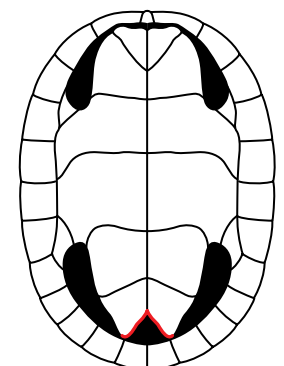
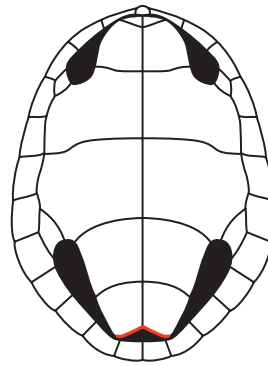

Pyxis planicauda 18

Cyclemys dentata 40

Batagur baska 47

Orlitia borneensis 47



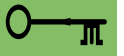

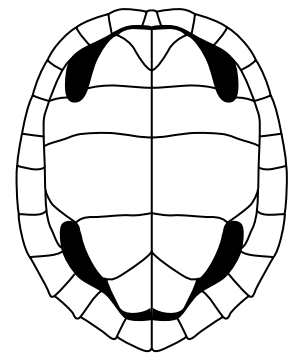
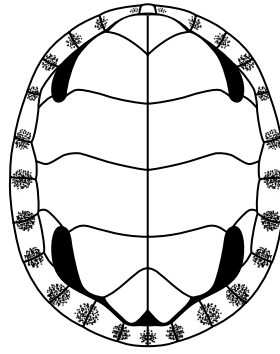
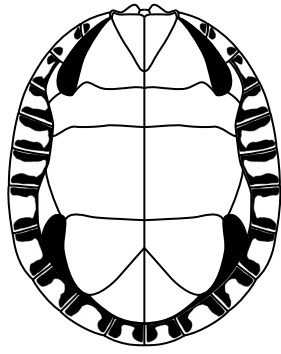
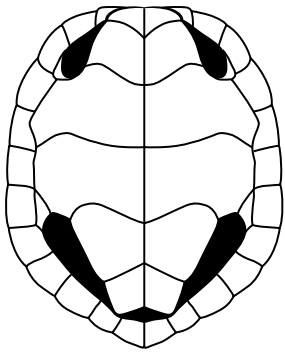

Emydidae 澤龜科



 *Callagur borneoensis* 48

 *Chrysemys picta picta* 50

 *Pseudemys floridana* 50

 *Graptemys geographica* 51

Emydidae 澤龜科

幼龜呈粉紅或紅色，
具有深色輻射狀花紋

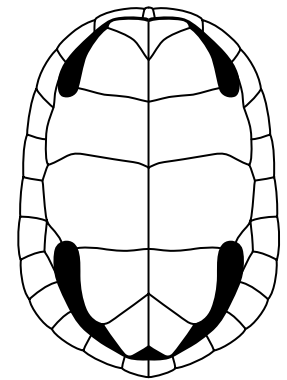
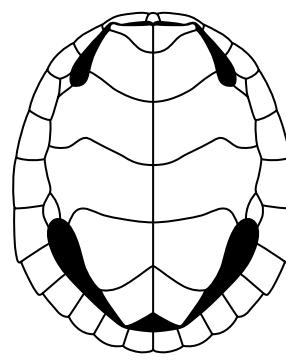
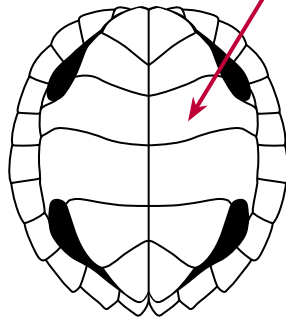
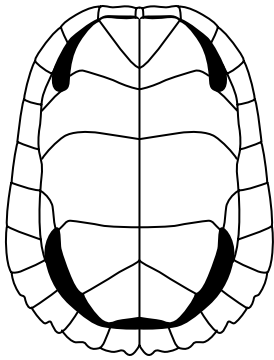

 *Trachemys terrapen* 52

 *Cyclemys tcheponensis* 54

 *Kachuga trivittata* 57

 *Morenia ocellata* 58

Emydidae 澤龜科

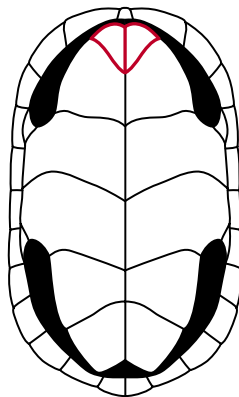
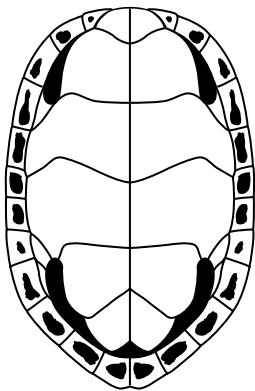

 *Morenia petersi* 58

 *Melanochelys tricarinata* 61

腹甲具有花紋

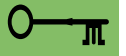

Testudinidae 象龜科

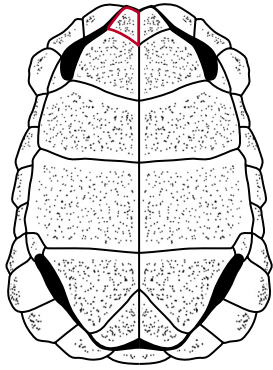

Kinixys homeana 5

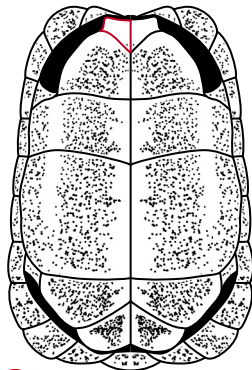

Kinixys belliana 5
 Kinixys natalensis 5

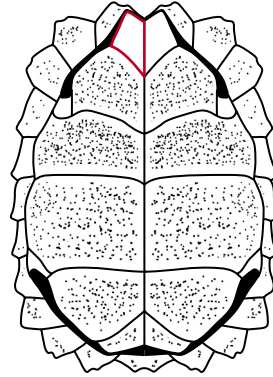

Kinixys erosa 5

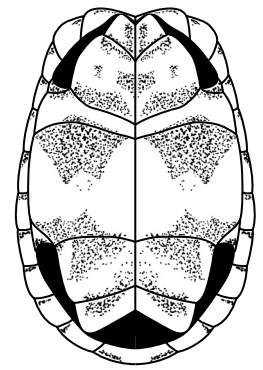

Geochelone platynota 5



Testudinidae 象龜科

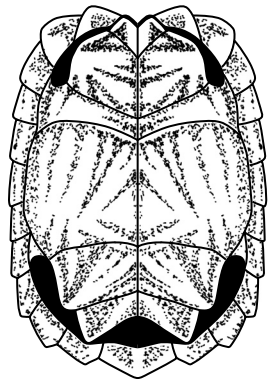

Geochelone elegans 5

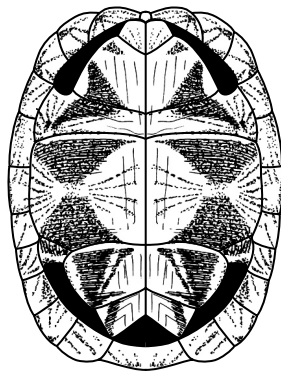

Geochelone radiata 5

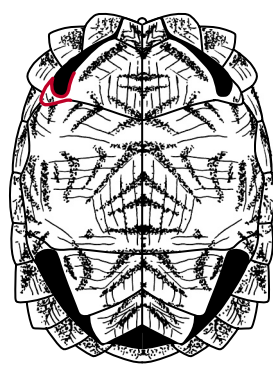

Psammobates oculiferus 6

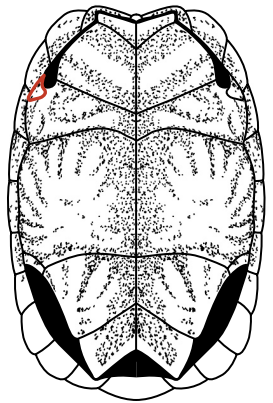

Psammobates geometricus 6

Testudinidae 象龜科

花紋隨個體變異

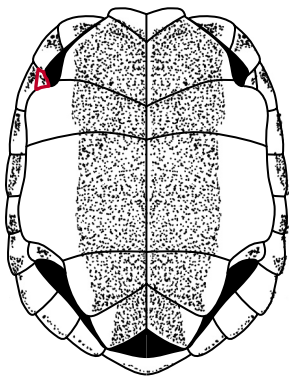

Psammobates tentorius 6

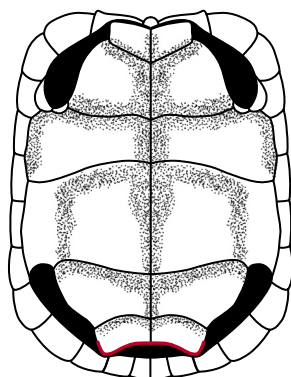

Malacochersus tornieri 7

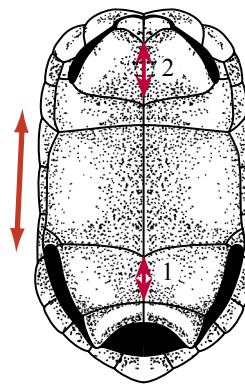

1 < 2

Geochelone denticulata 9

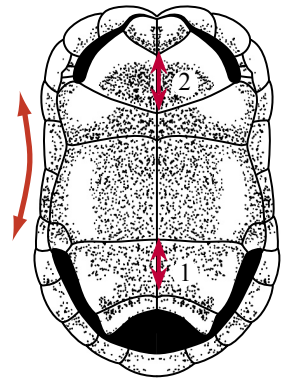

1 ≥ 2

Geochelone carbonaria 9



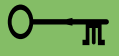

Testudinidae 象龜科

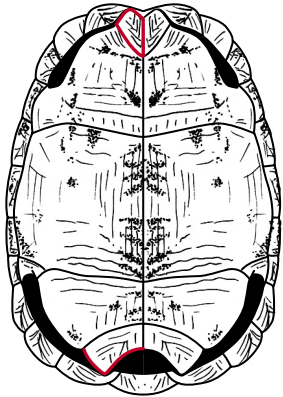

Geochelone pardalis 10

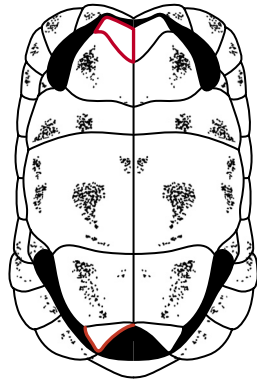

Indotestudo forstenii 10

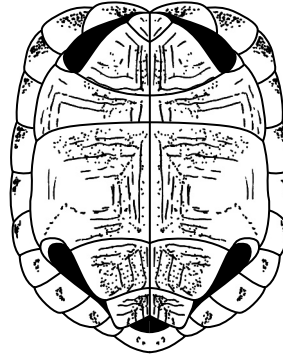

Geochelone chilensis 11

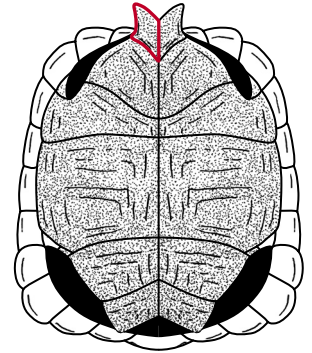

Gopherus berlandieri 12

Testudinidae 象龜科

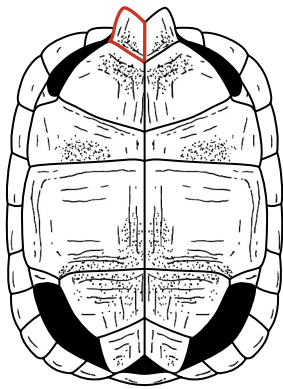

Gopherus agassizii 12

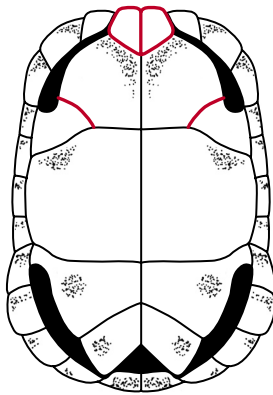

Manouria emys 13

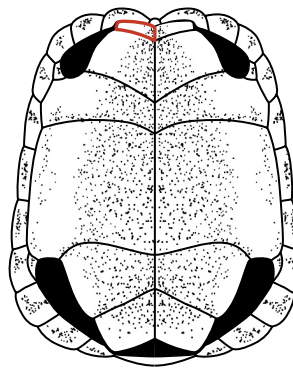

Homopus areolatus 14

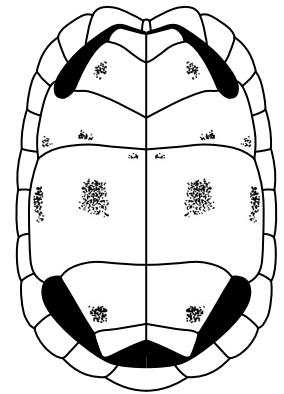

Indotestudo elongata 17

Testudinidae 象龜科

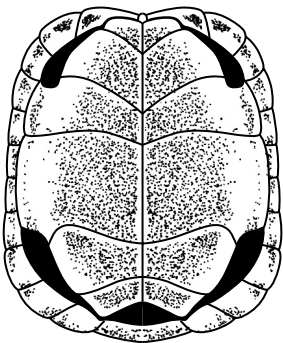

Testudo horsfieldii 17

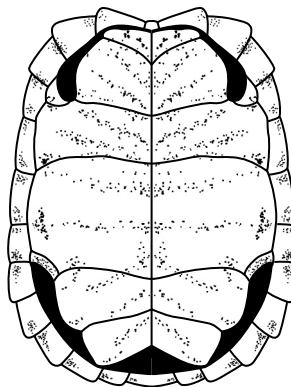

Homopus signatus 18

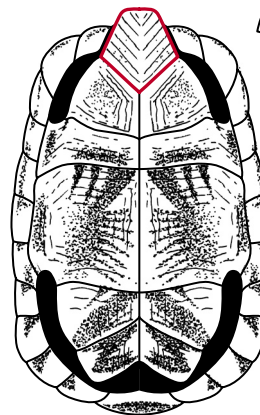

Chersina angulata 19

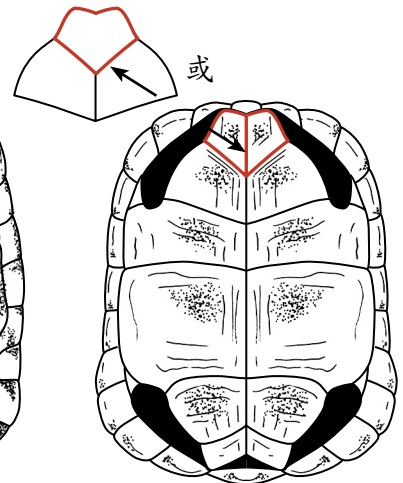

Gopherus flavomarginatus 19



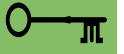

Emydidae 澤龜科

花紋隨個體變異

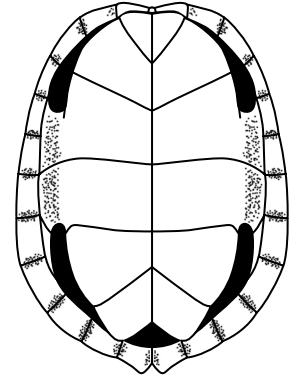
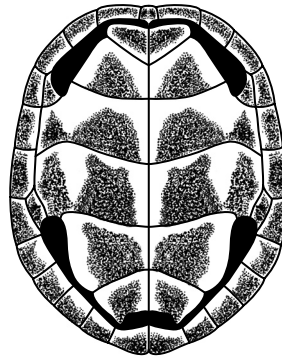
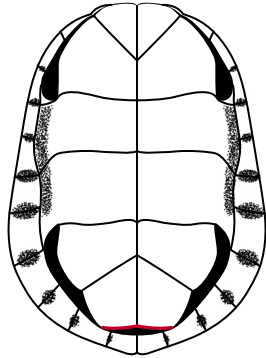
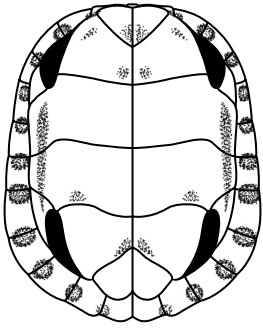

Pseudemys rubriventris 46

Deirochelys reticularia 47

Ocadia sinensis 48

Clemmys marmorata 49

Emydidae 澤龜科

花紋隨個體變異

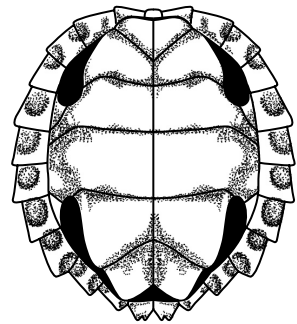
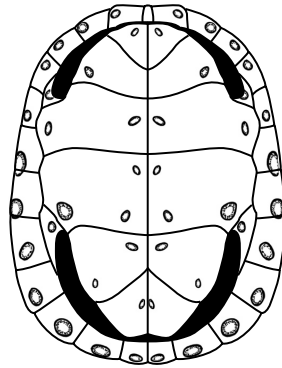
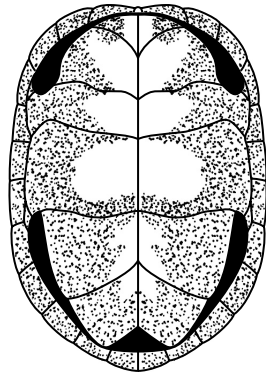
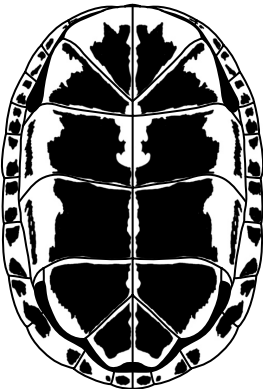

Clemmys guttata 49

Clemmys muhlenbergii 49

Trachemys decorata 50

Graptemys oculifera 51

Emydidae 澤龜科

花紋隨個體變異

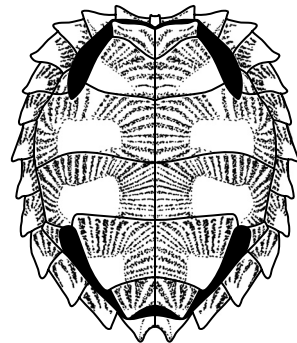
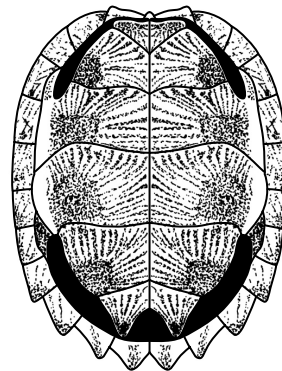
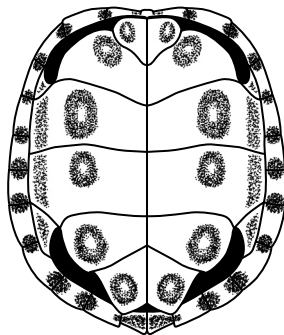
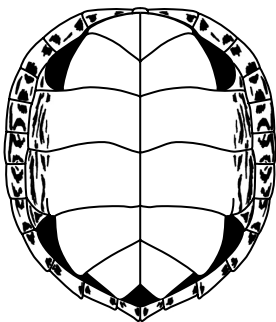

Graptemys pseudogeographica pseudogeographica 51

Trachemys scripta elegans 52

Heosemys grandis 53

Heosemys spinosa 53



腹甲具有花紋

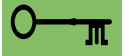

Emydidae 澤龜科

有時具有花紋

有些個體具有花紋，有些則無

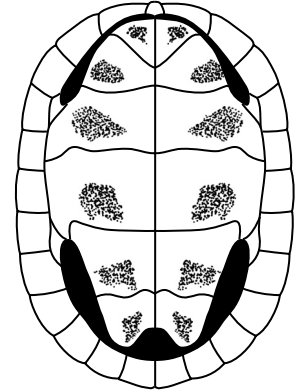
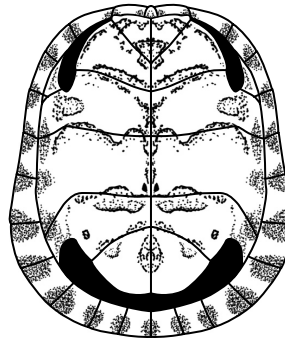
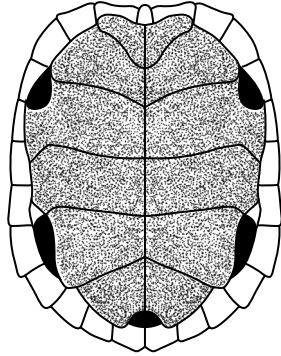
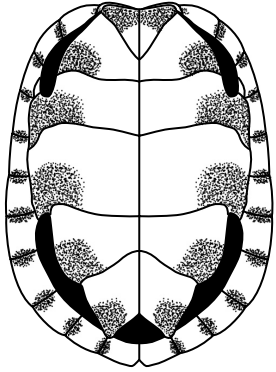

Clemmys insculpta 54



Siebenrockiella crassicollis 54



Trachemys stejnegeri 56



Hieremys annandalii 56

Emydidae 澤龜科

有些個體具有花紋，有些則無

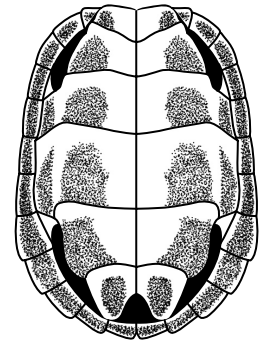
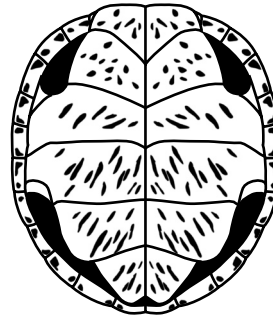
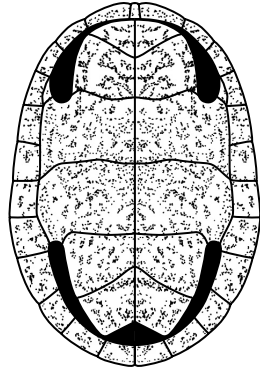
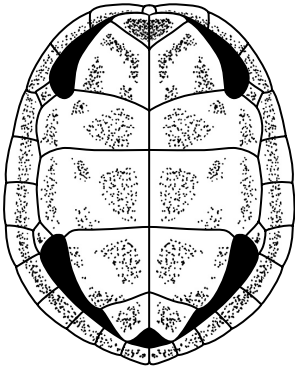

Kachuga tecta 57



Sacalia quadriocellata 57



Malaclemys terrapin 58



Chinemys nigricans 60

Emydidae 澤龜科

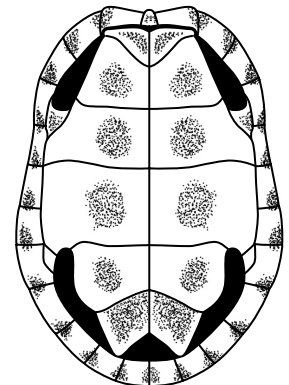
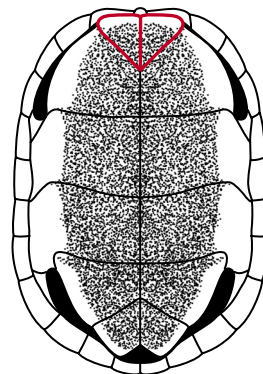
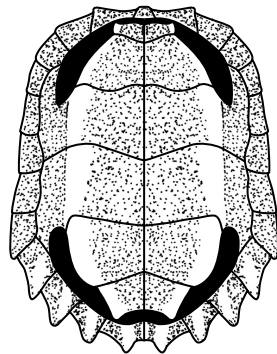
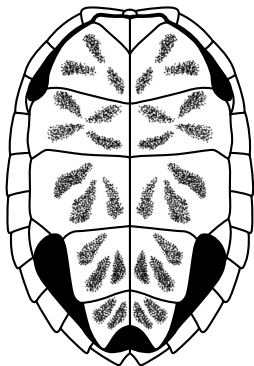

Geoclemys hamiltonii 60



Geoclemys spengleri 60



Melanochelys trijuga 61





Malayemys subtrijuga 62

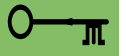

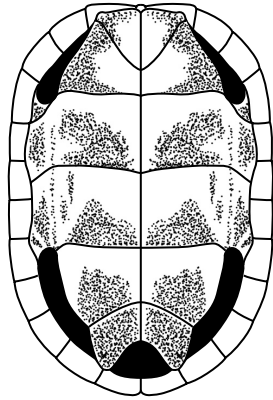
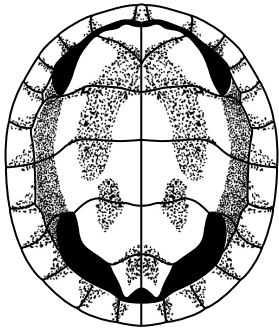

Emydidae 澤龜科



 *Annamemys annamensis* 62

 *Chinemys reevesii* 62



Blue Section 藍色敘述頁

藍色敘述頁的圖示內容
主要為容易辨認的龜類



Cheloniidae 蠍龜科 : 7 Spp. I 0 Sp.

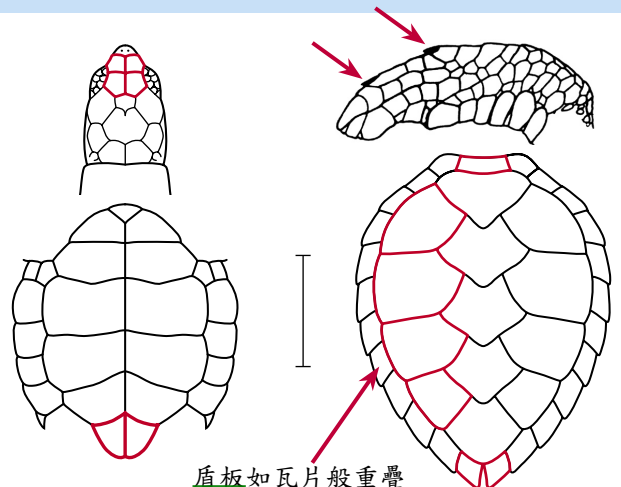
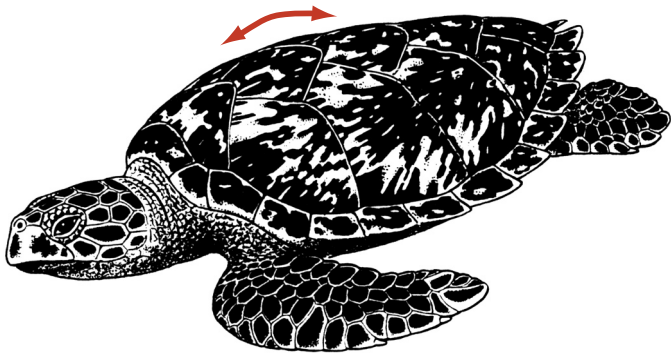

盾板如瓦片般重疊

Eretmochelys imbricata

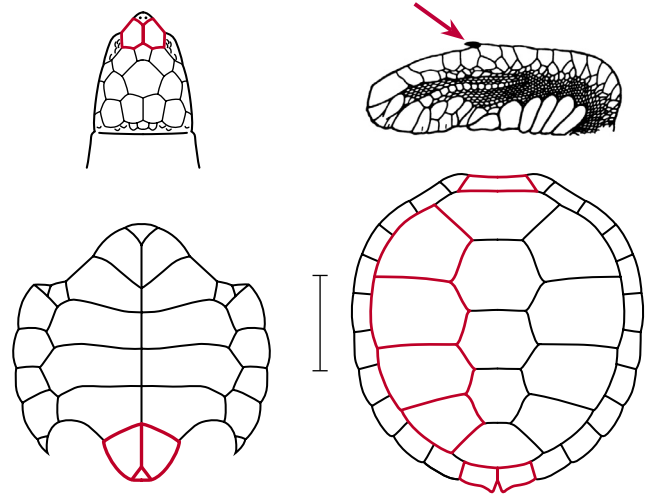
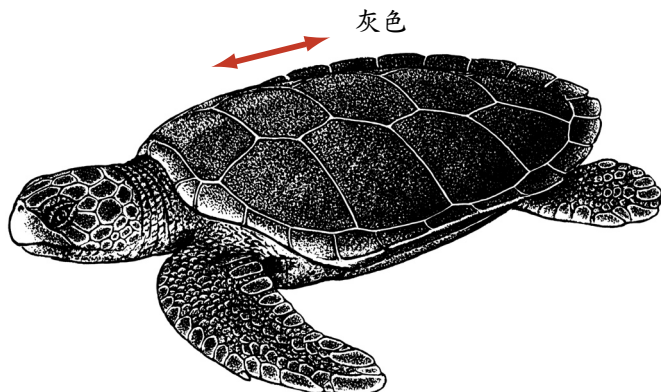

Natator depressa

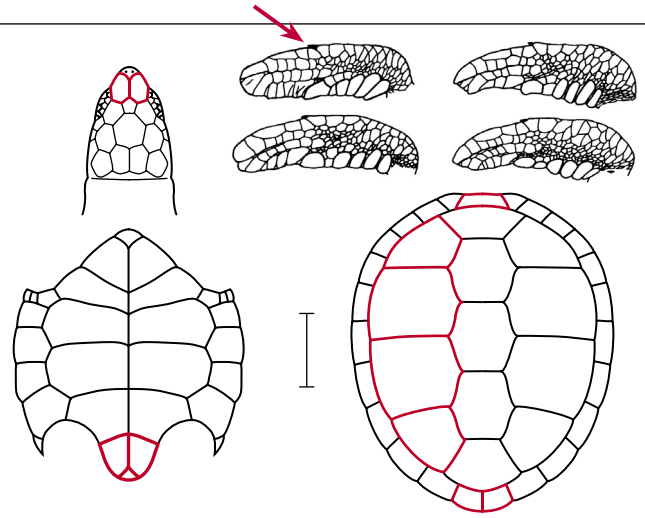
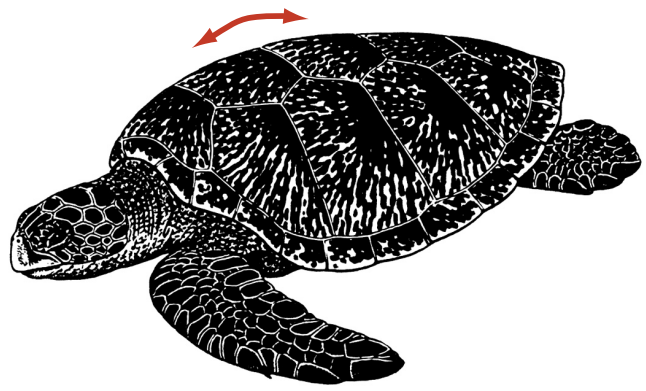

Chelonia mydas **Chelonia agassizii*
 *Chelonia agassizii** (黑海龜) 背甲較高，斑點顏色較深，後肢上方具有鋸齒狀緣。

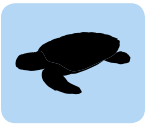

棕色

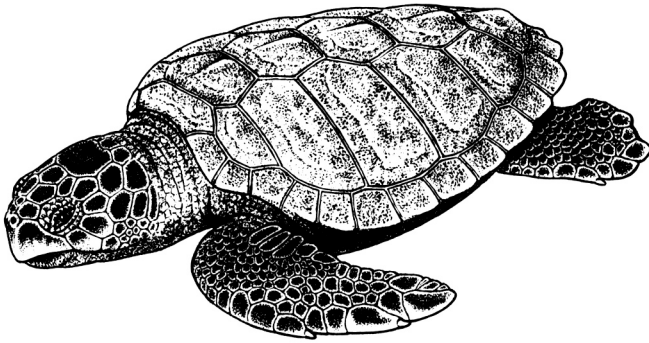

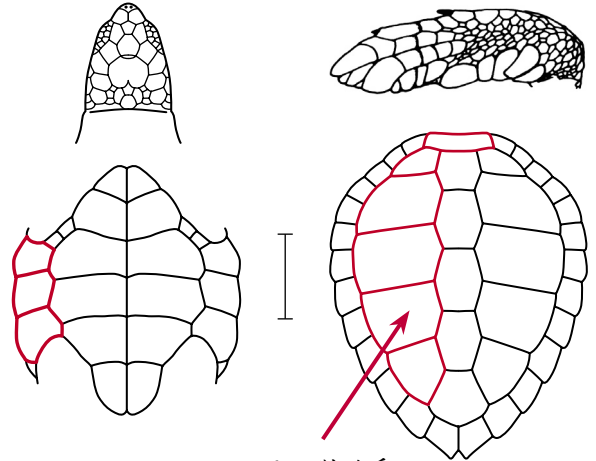

 *Caretta caretta*

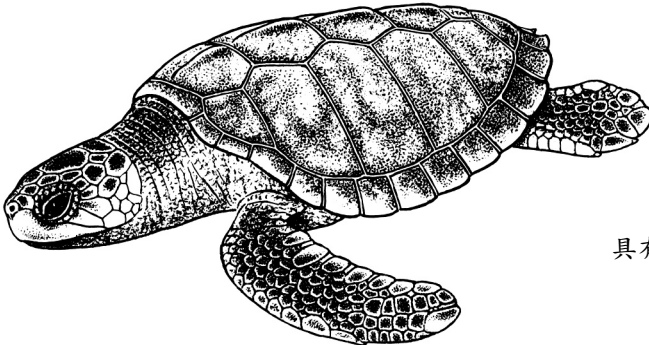

五至六對肋盾

灰色



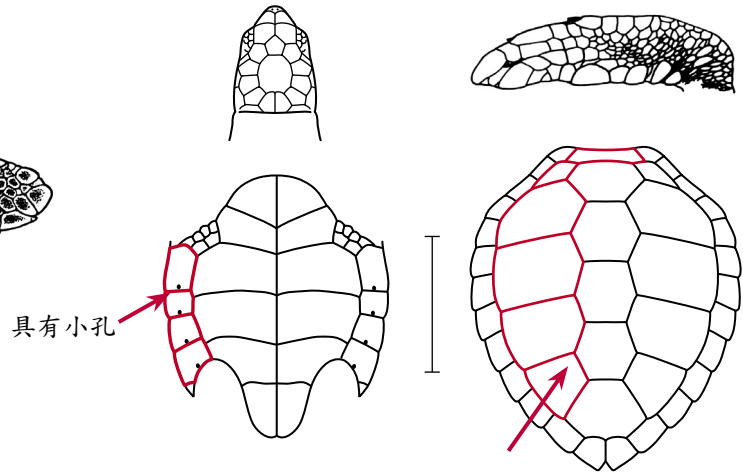

 *Lepidochelys kempii*

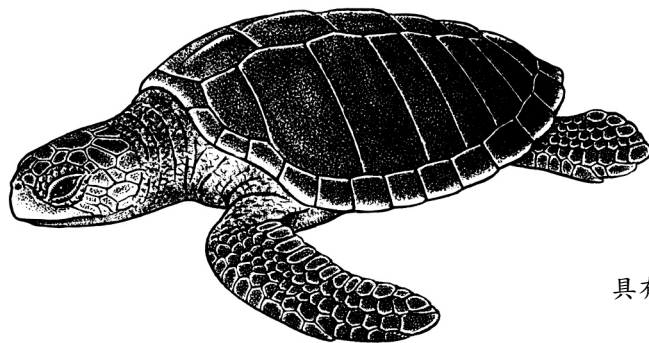

五至六對肋盾

橄灰色



 *Lepidochelys olivacea*

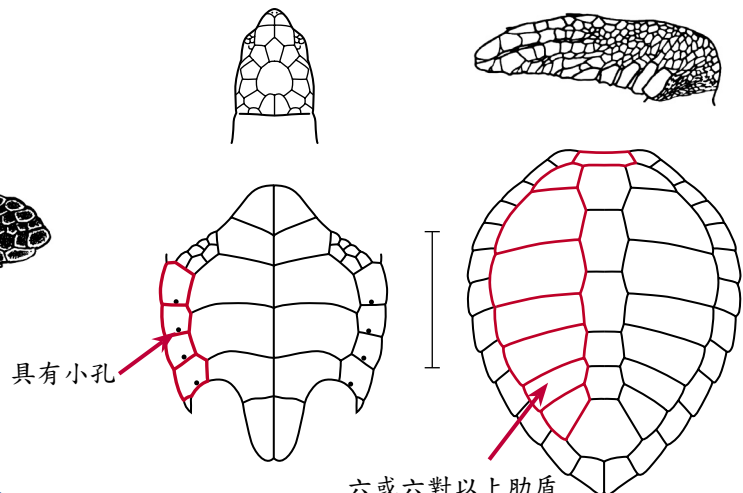

六或六對以上肋盾



Dermodochelyidae 革龜科：🚫 1 Sp. 🟢 0 Sp.

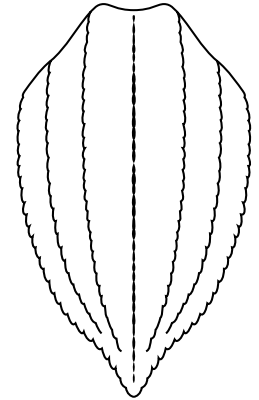
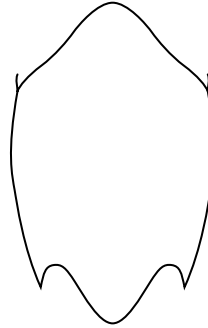
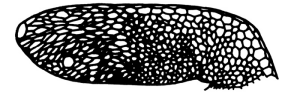
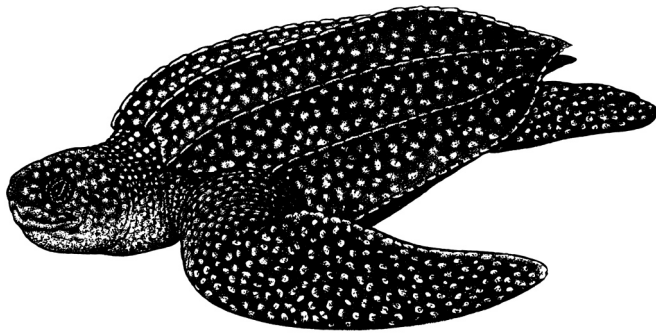

🚫 *Dermochelys coriacea*



Carettochelyidae 豬鼻龜科：🚫 0 Sp. 🟢 1 Sp.

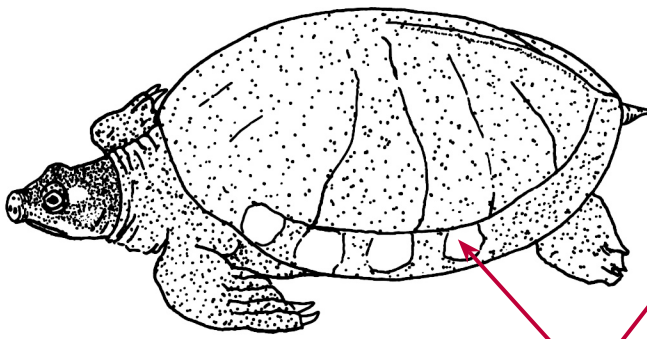

具二爪

白色

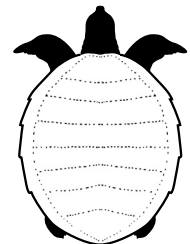
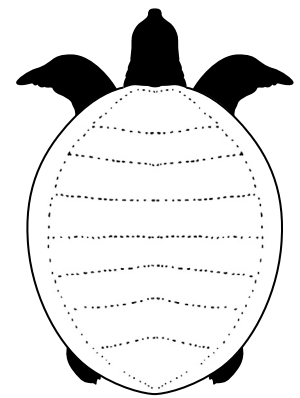
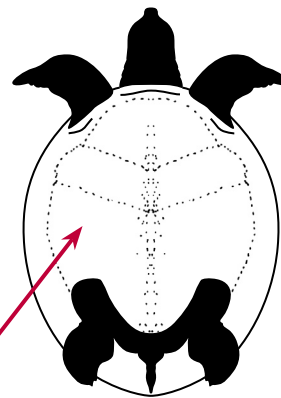

幼龜

🟢 *Carettochelys insculpta*





Testudinidae 象龜科：🚶 40 Spp. I 或 II 🚶 0 Sp.

部分個體具有稜脊，
有些個體則無

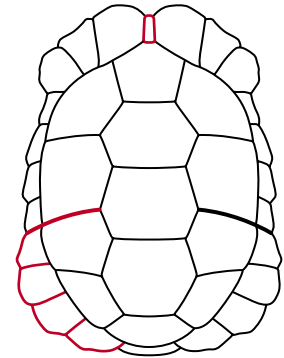
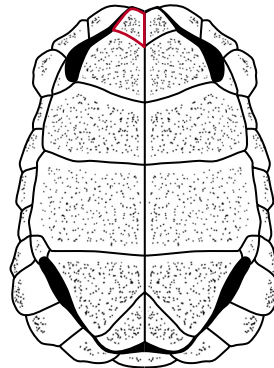
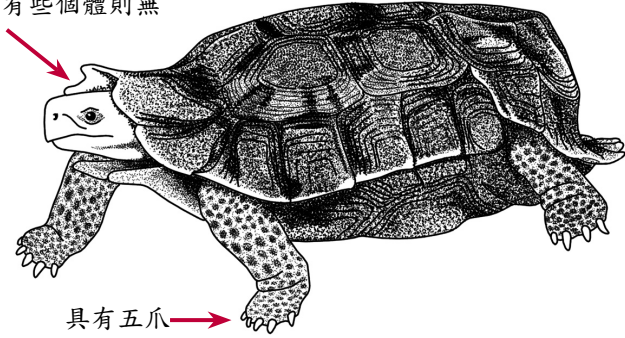

韌帶

🚶 *Kinixys homeana*

Kinixys 幼體的韌帶構造發育不完全，第一椎盾的寬度大於長度。

部分個體具有稜脊，
有些個體則無

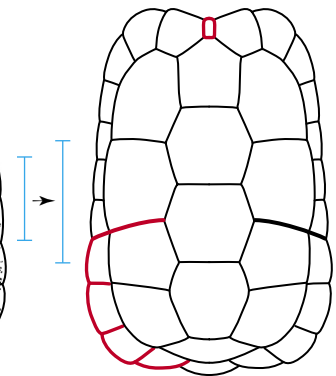
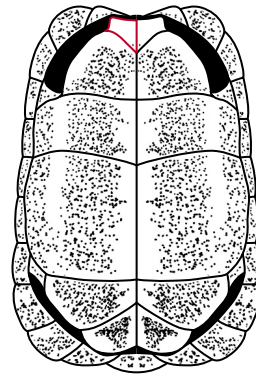
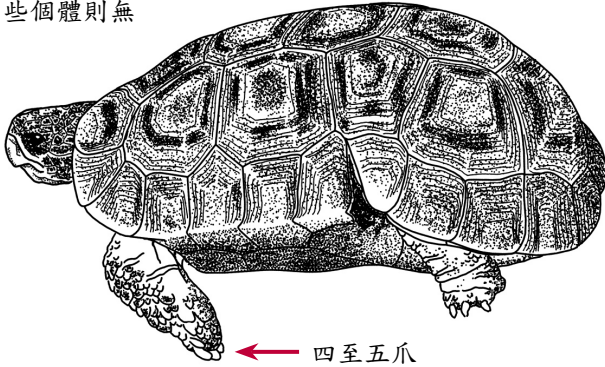

韌帶

🚶 *Kinixys belliana* 🚶
🚶 *Kinixys natalensis**

* *Kinixys natalensis* 的上肛盾明顯分為二片，
腹甲上有二個黑色環狀花紋。



不具稜脊

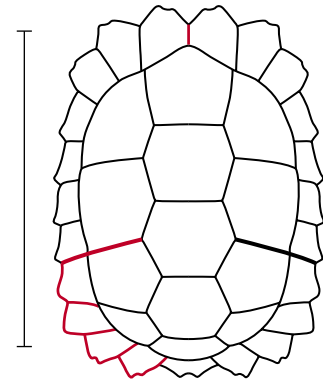
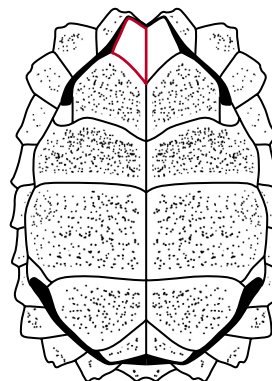
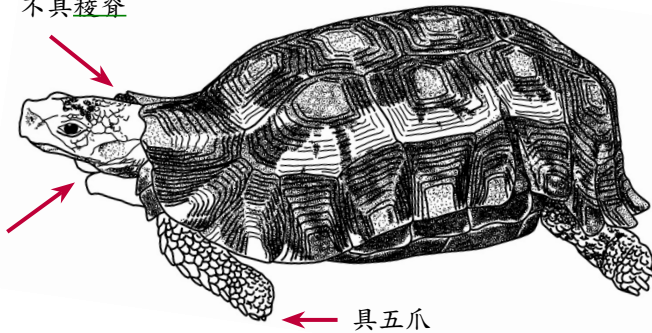

韌帶

🚶 *Kinixys erosa* 🚶



Trionychidae 鰲科 : 6 Spp. I, II 或 III 17 Sp.

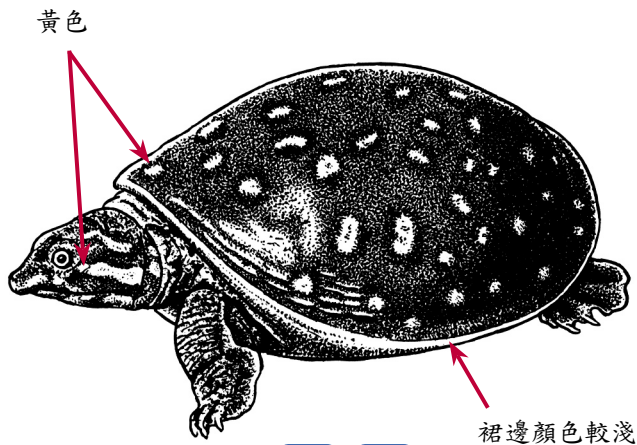

Lissemys punctata

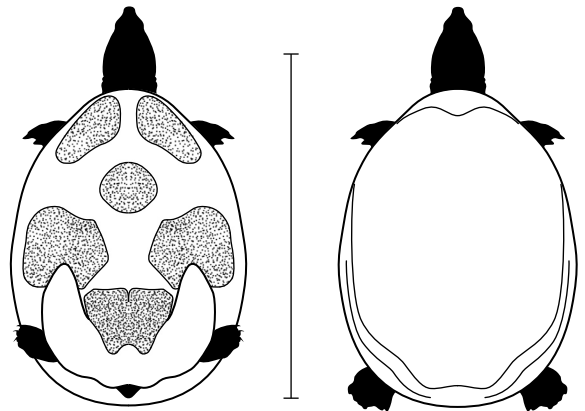

幼體具有疣凸

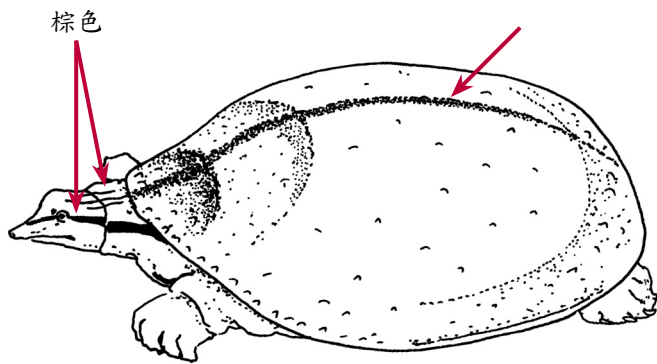

Cycloderma aubryi

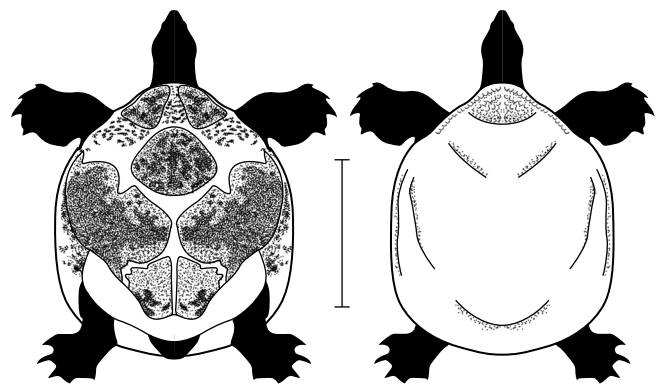

幼體具有疣凸及稜脊

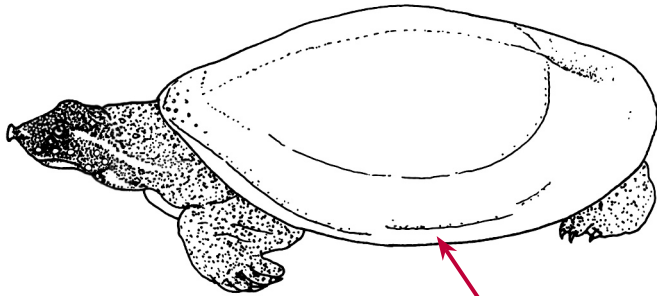
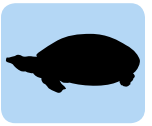

裙邊顏色較淺

Cyclanorbis senegalensis



腹甲呈乳白色，具棕色斑點

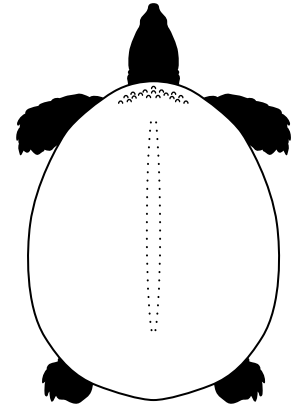

幼龜背甲上具有疣凸及稜脊

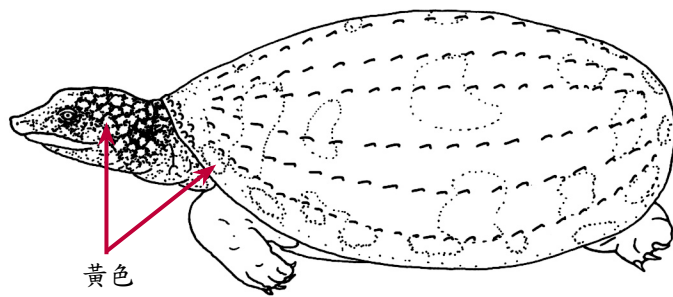

黃色

Cyclanorbis elegans

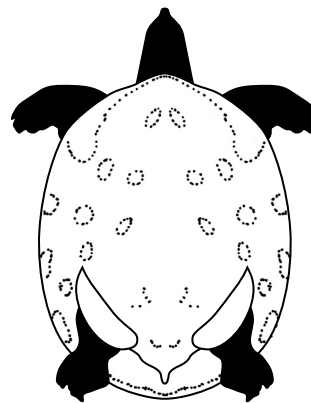

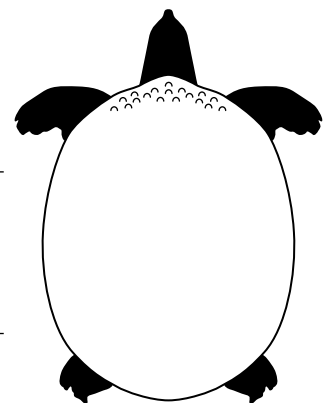

腹甲呈黃色，具深色斑點





幼龜背甲上具有疣凸及稜脊



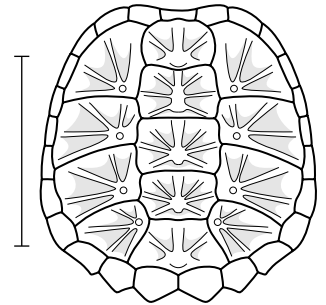
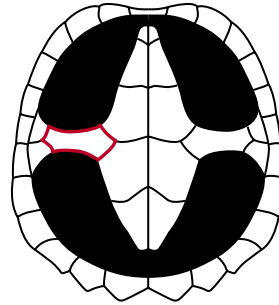
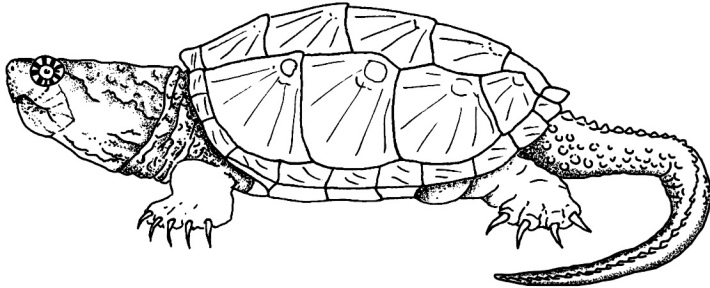

Chelydridae 鱷龜科 :  0 Sp.  2 Spp.

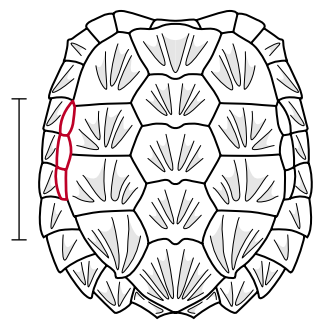
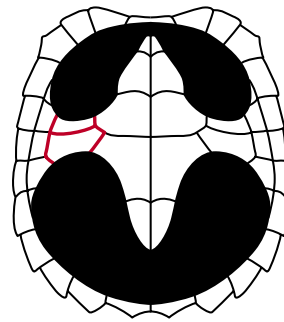
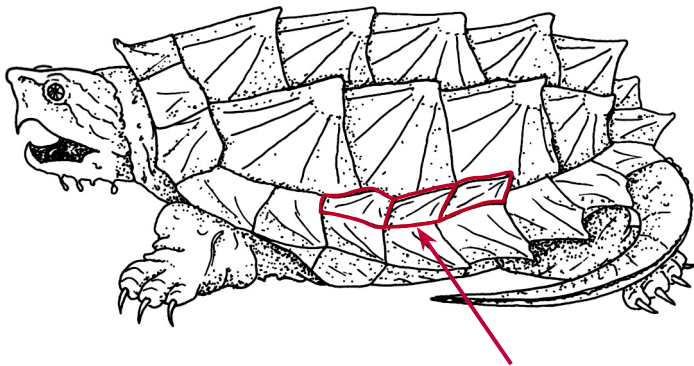

 *Chelydra serpentina* 



 *Macrolemys temminckii* 

下緣盾三至八塊



Platysternidae 平胸龜科 : 0 Sp. 1 Sp.

特化的巨大鱗片

頭部無法縮入背甲內

幼龜具有稜脊

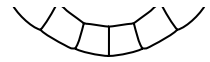
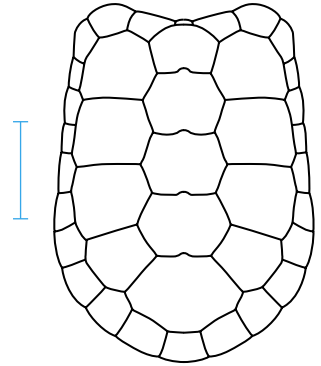
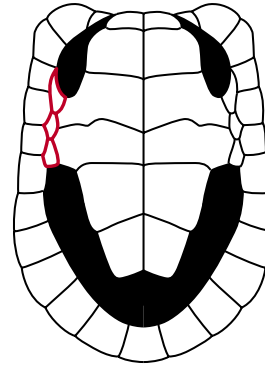
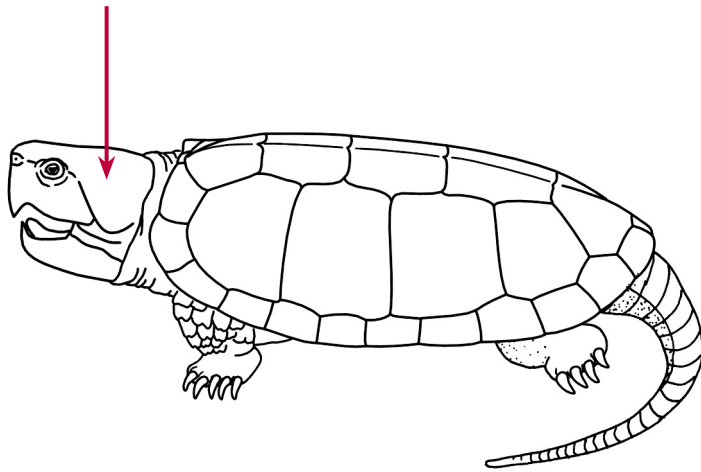

上肛盾有時分為二片

Platysternon megacephalum

Yellow Section 黃色敘述頁

黃色敘述頁圖示中的龜鱉物種或亞種，需仔細觀察或需要諮詢專家。



Testudinidae 象龜科 :  40 Spp. I 或 II  0 Sp.

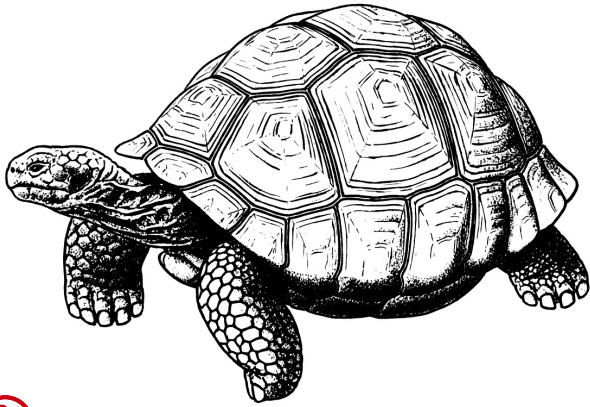

 *Geochelone nigra*

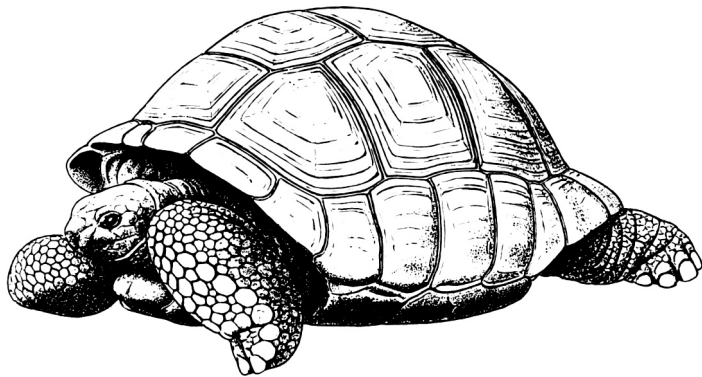
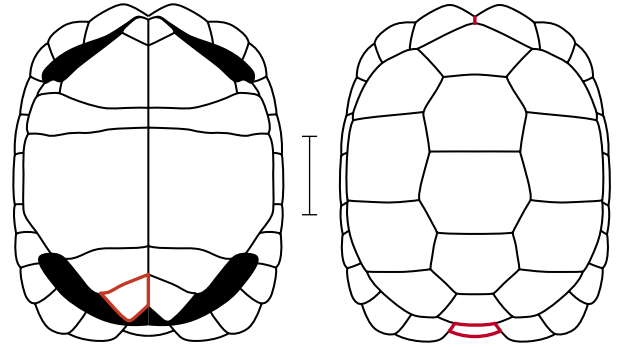

 *Geochelone gigantea*

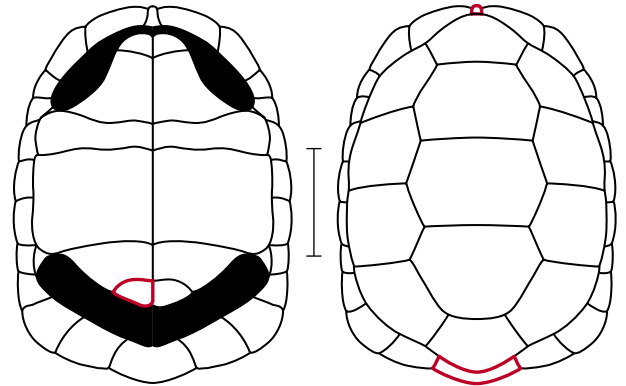

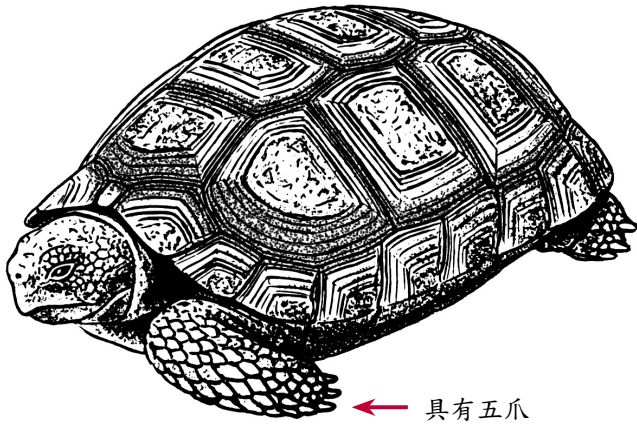

← 具有五爪

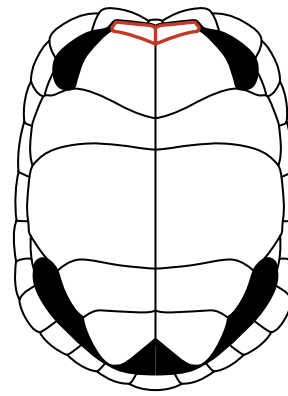

緣盾數為12對

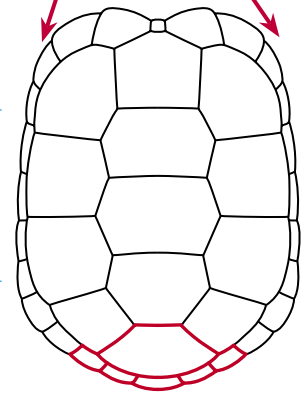

 Homopus boulengeri

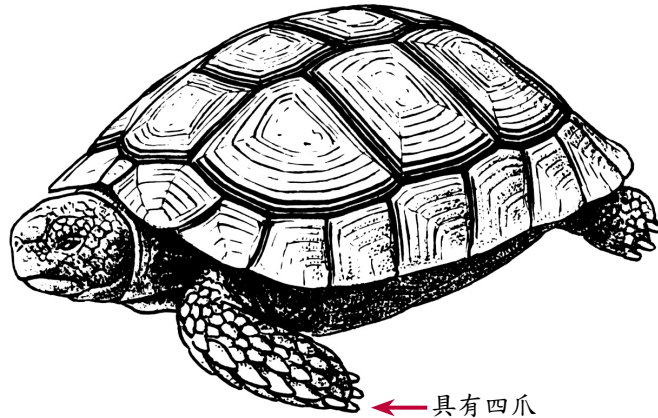

← 具有四爪

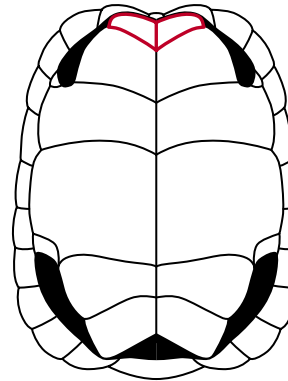

緣盾數為11對

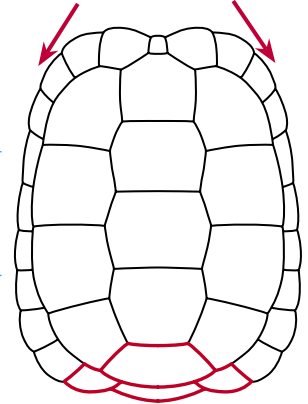

 Homopus femoralis



下列種類的成體或幼龜之背甲亦呈一致的顏色

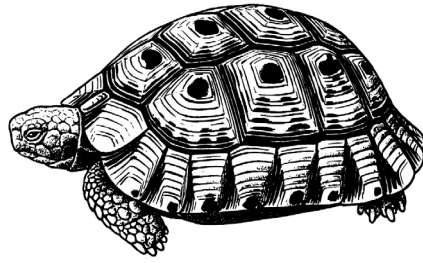

 Testudo graeca 16

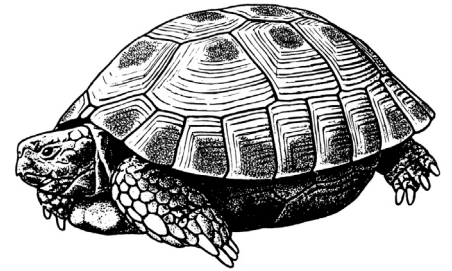

 Testudo horsfieldii 17

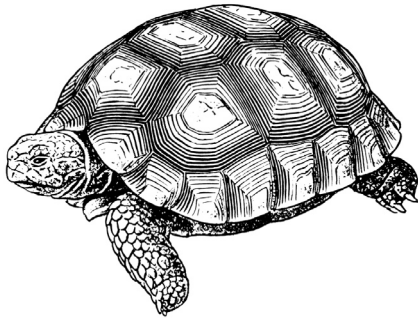

 Geochelone chilensis 11

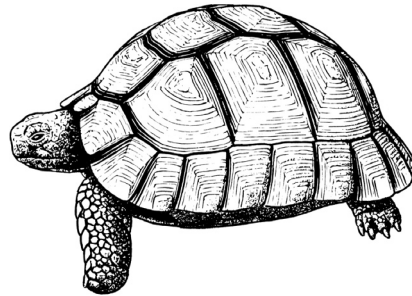

 Testudo kleinmanni 17

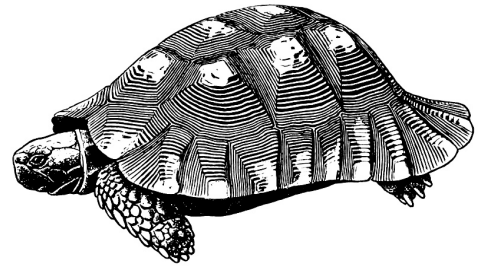

 Testudo marginata 14

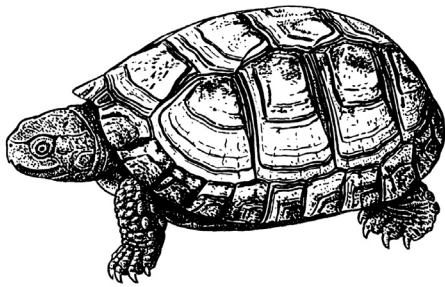

 Terrapene coahuila (Emydidae) 43

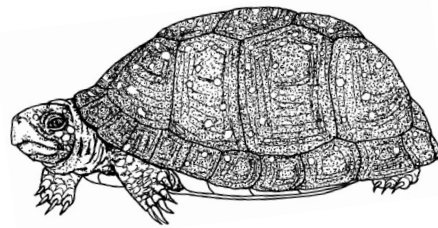

 Terrapene nelsoni (Emydidae) 44

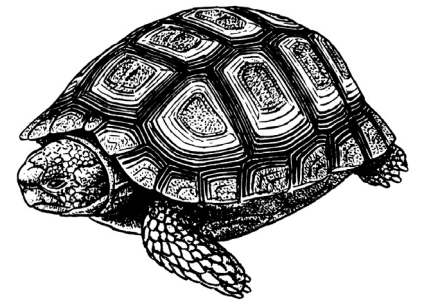

 Homopus areolatus (juv.) 14

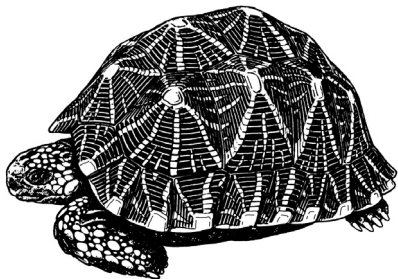

 Geochelone elegans (juv.) 5

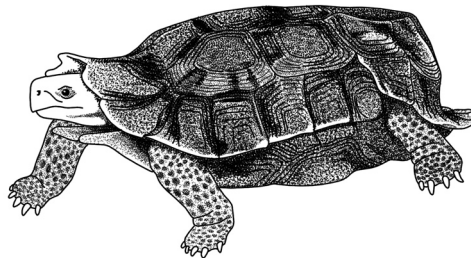

 Kinixys homeana (juv.) 5

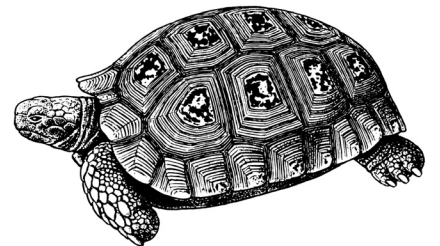

 Manouria emys 13



Testudinidae 象龜科： 40 Spp. I 或 II 0 Sp.

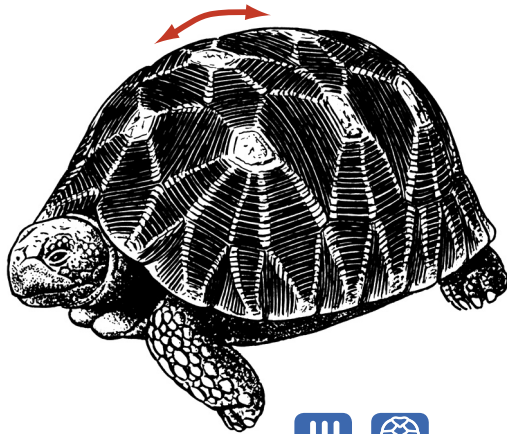

Geochelone platynota

椎盾數為五至六塊

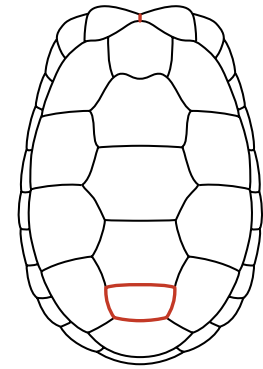
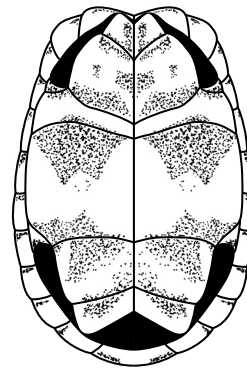

幼體呈鋸齒狀

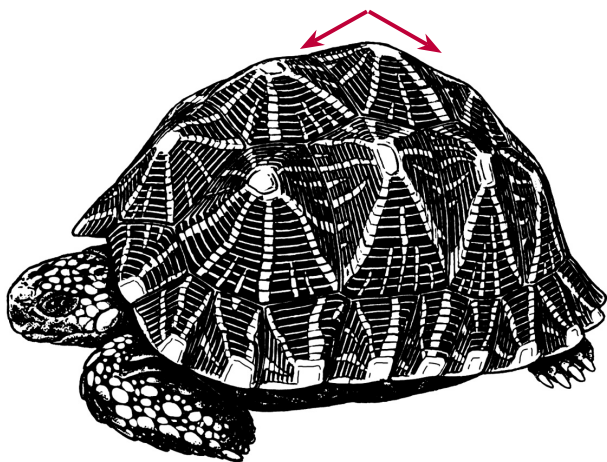

Geochelone elegans

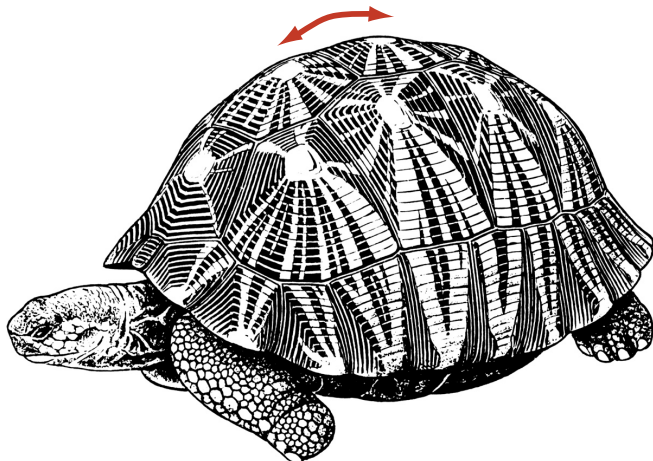
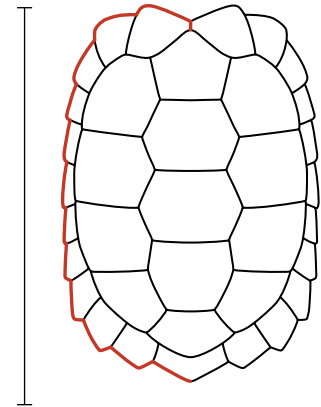
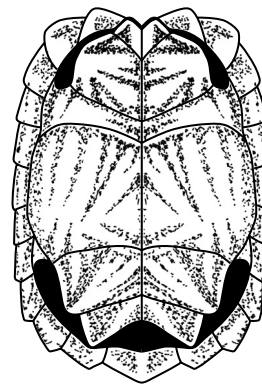

Geochelone radiata

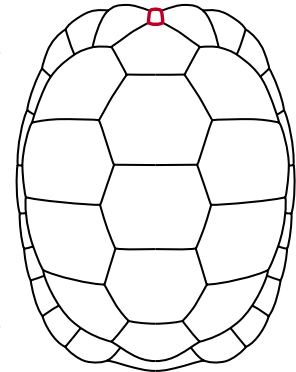
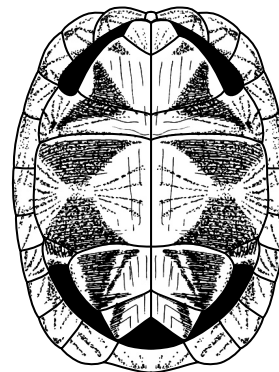

幼體呈鋸齒狀

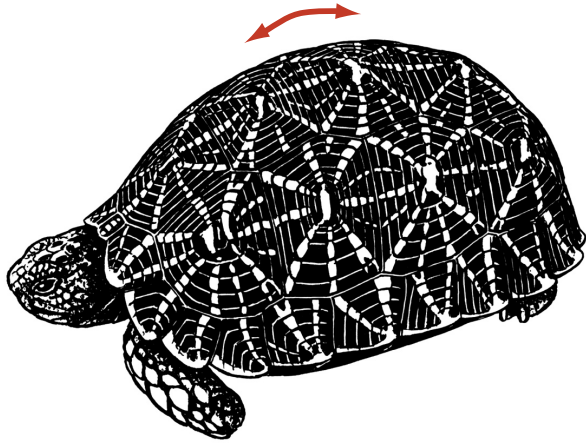

腋盾與肱盾癒合

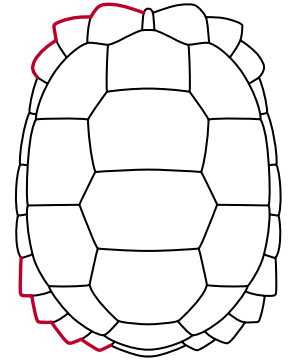
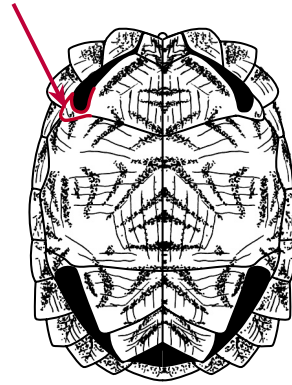

 *Psammobates oculiferus*

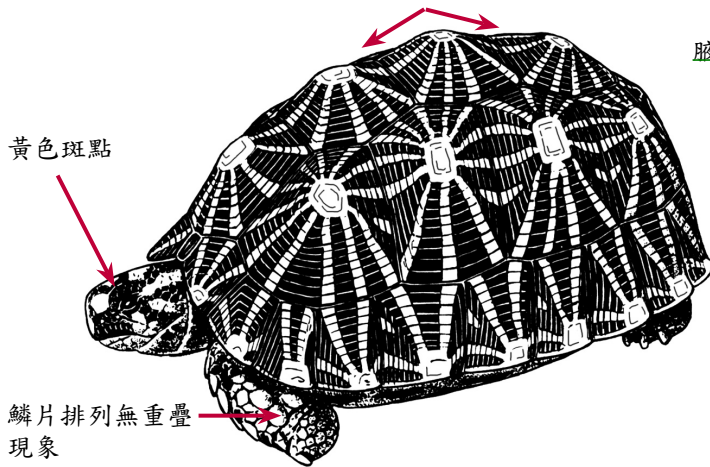

腋盾數為一塊 (無下緣盾)

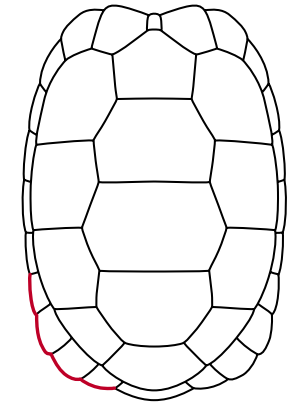
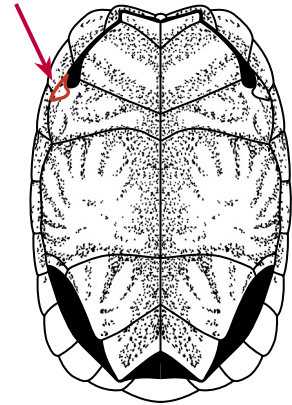

 *Psammobates geometricus*

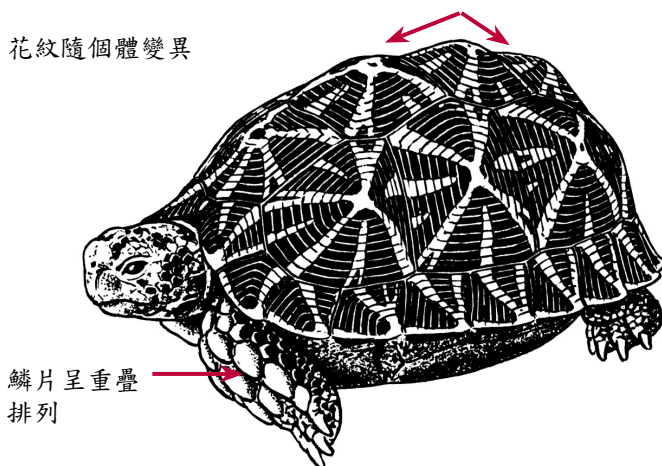

腋盾數二至三塊 (無下緣盾)

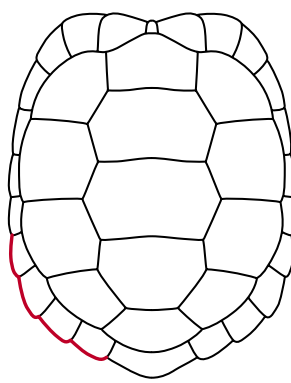
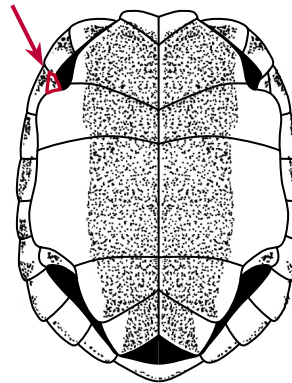

 *Psammobates tentorius*

花紋隨個體變異

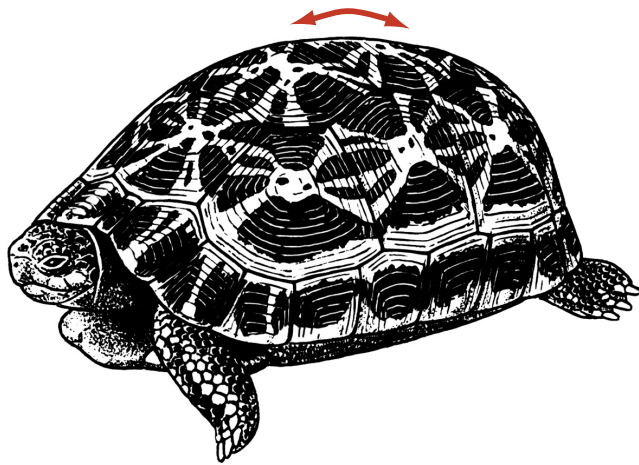

韌帶構造隨不同亞種而異

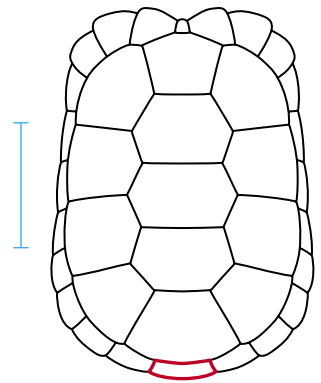
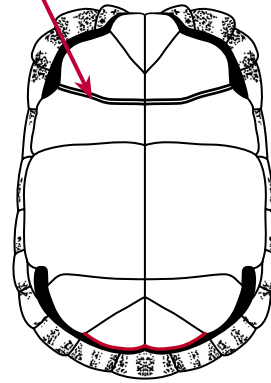

幼體具有花紋

 Pyxis arachnoides

背甲非常扁平

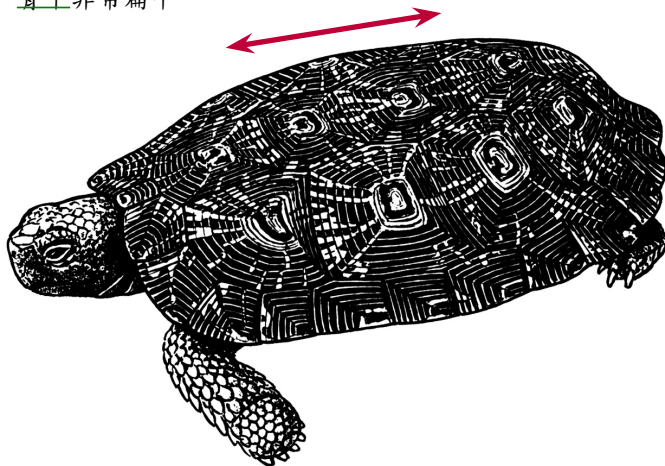

花紋隨個體變異

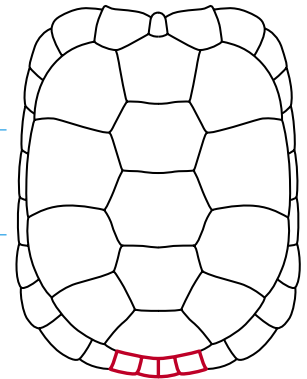
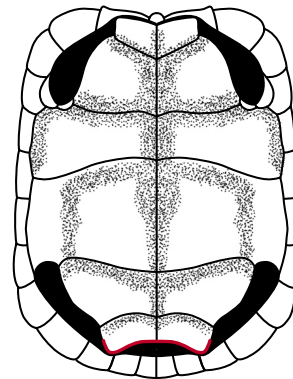



腹甲會隨其呼吸而上下起伏

 Malacochersus tornieri

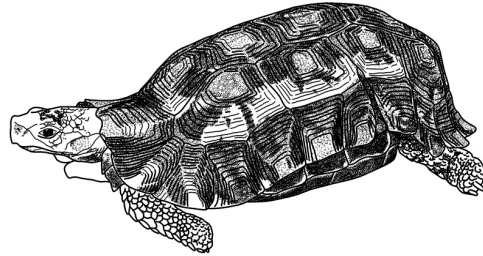

下列種類的成體或幼龜有時亦出現有星狀花紋



 *Kinixys erosa* (juv.) 5

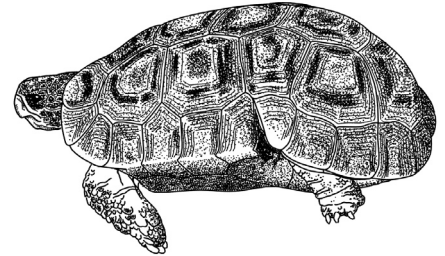

 *Kinixys belliana* 5

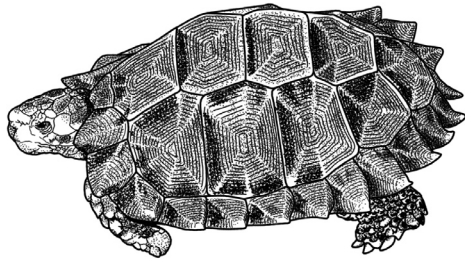

 *Manouria impressa* 18

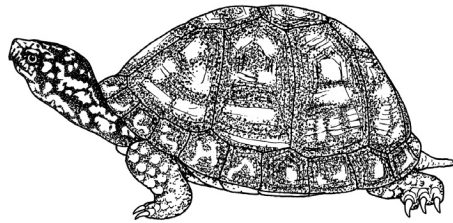

 *Terrapene carolina*
(Emydidae) 43

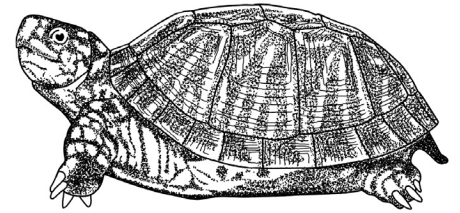

 *Terrapene ornata*
(Emydidae) 44



Testudinidae 象龜科：🚫 40 Spp. I 或 II 🚶 0 Sp.

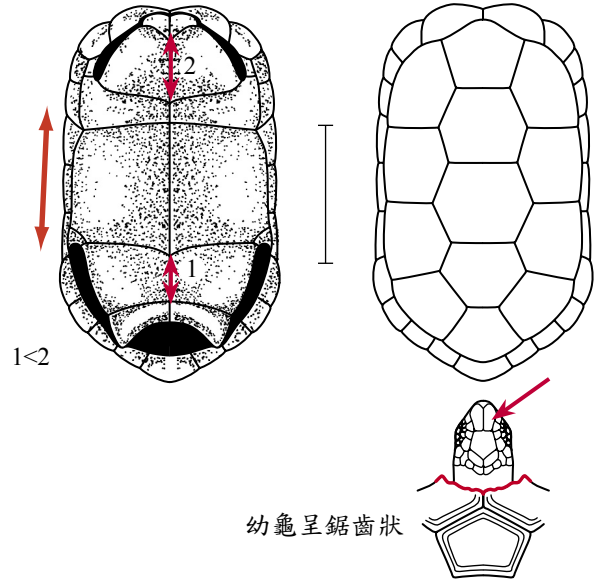
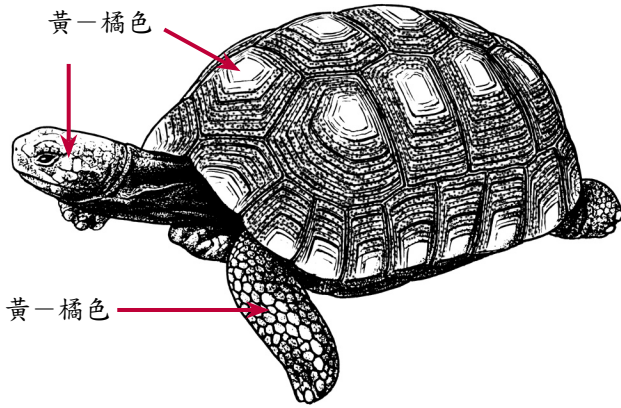

🚫 *Geochelone denticulata*

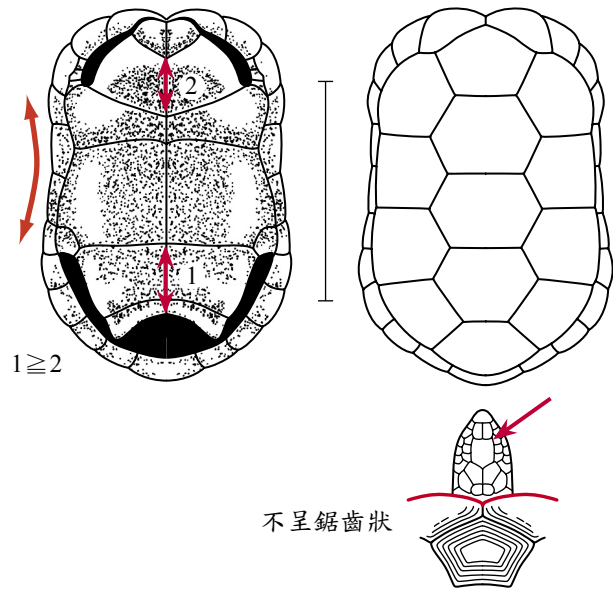
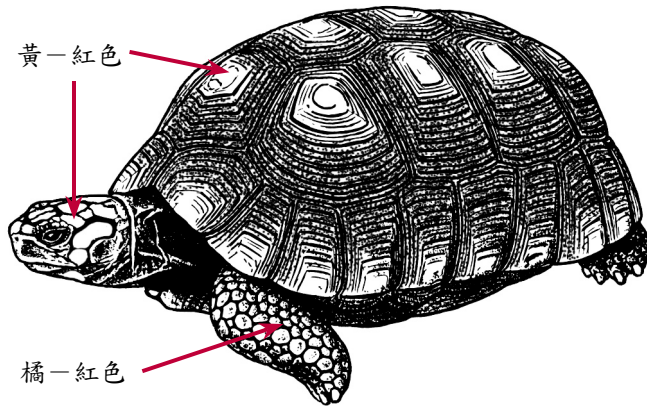

🚫 *Geochelone carbonaria* 🍴



黃-棕色

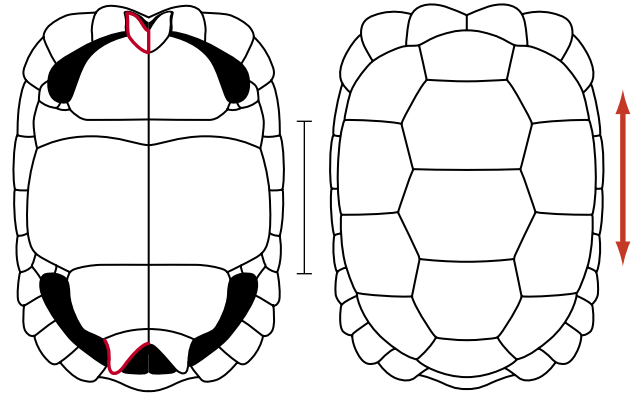
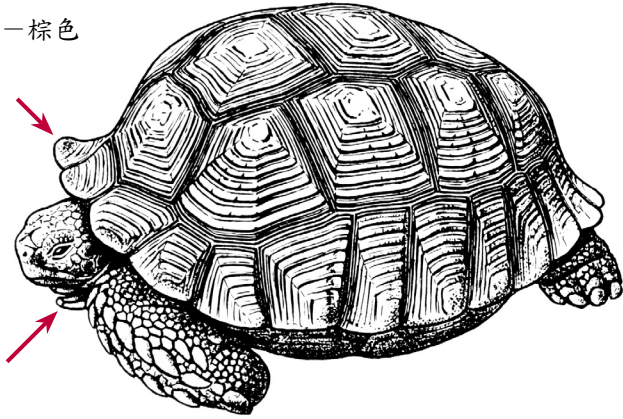

 *Geochelone sulcata*



呈黃色間有黑色花紋

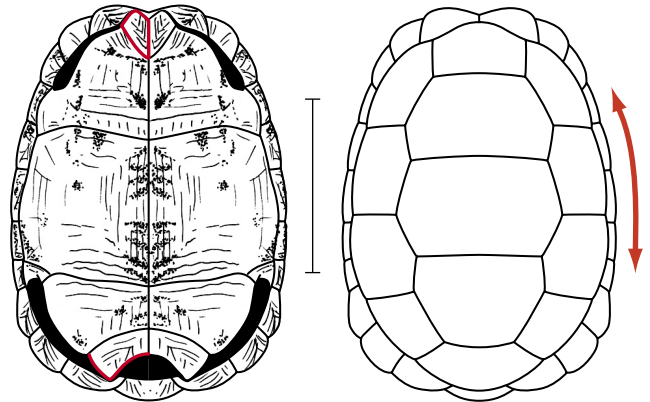
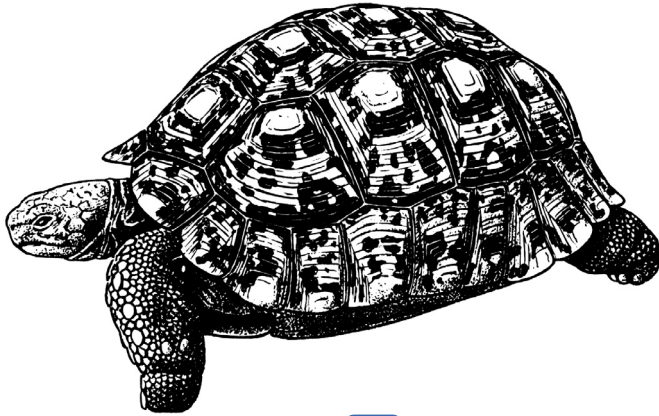

 *Geochelone pardalis*



棕色或橄欖色間有深色花紋

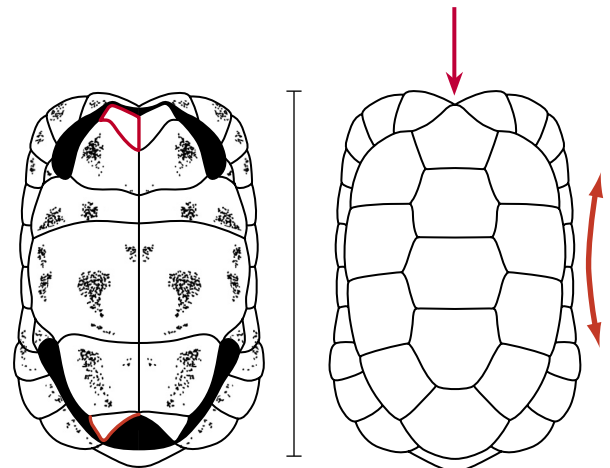
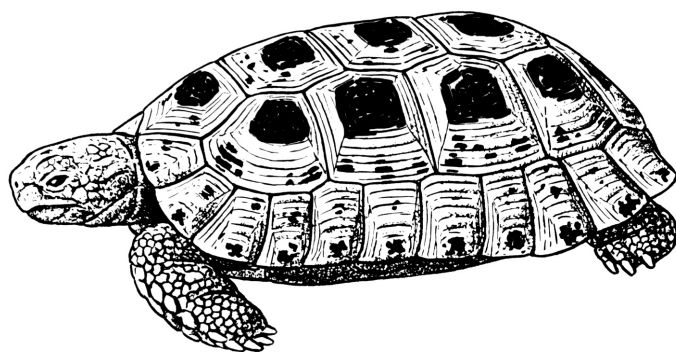

 *Indotestudo forstenii*



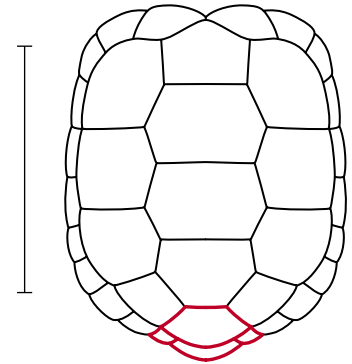
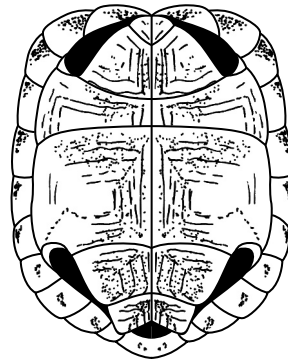
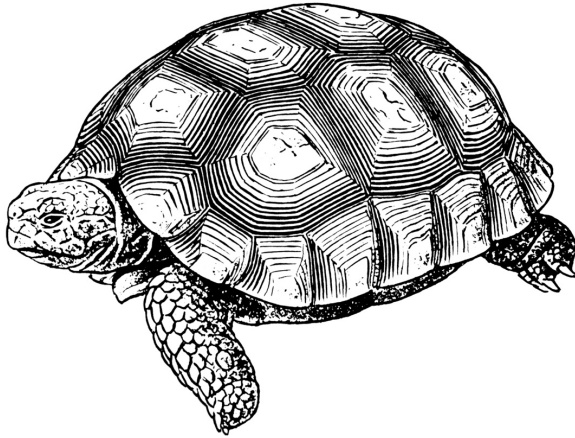

呈棕色有黑色生長輪

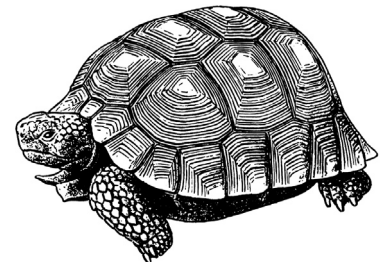
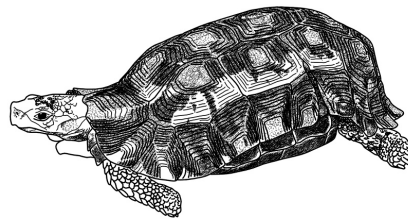

 *Geochelone chilensis*

下列種類的成體或幼體之背甲
有時具有斑點，不具頸盾





 *Kinixys erosa* (juv.) 5

 *Gopherus berlandieri* 12



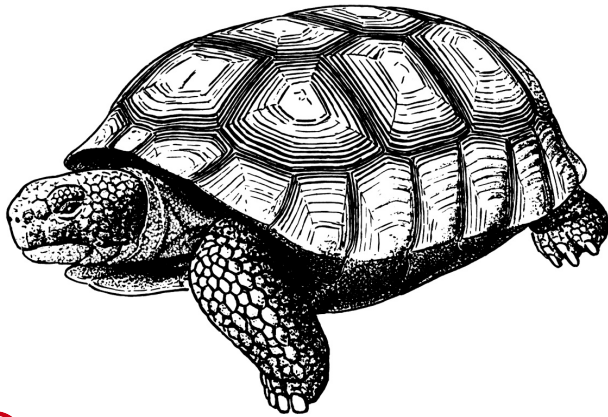

Testudinidae 象龜科： 40 Spp. I 或 II 0 Sp.

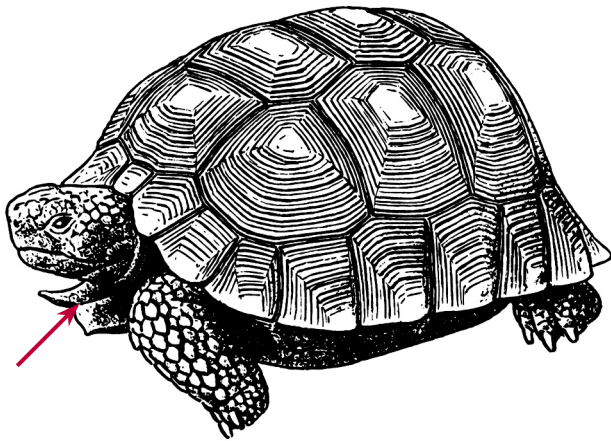
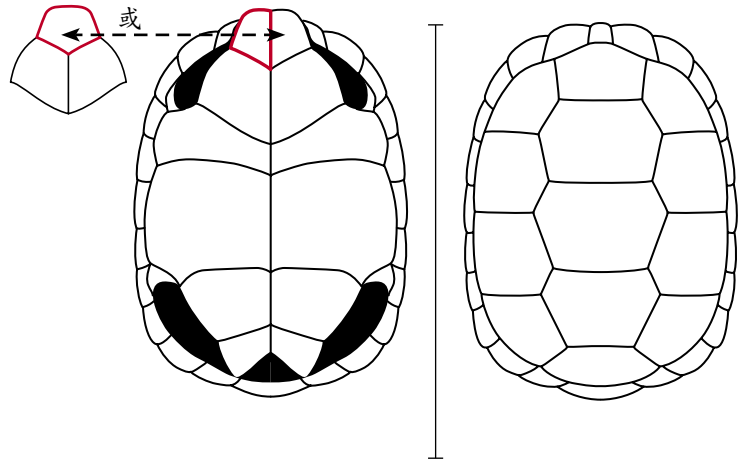

 *Gopherus polyphemus*



 *Gopherus berlandieri* 

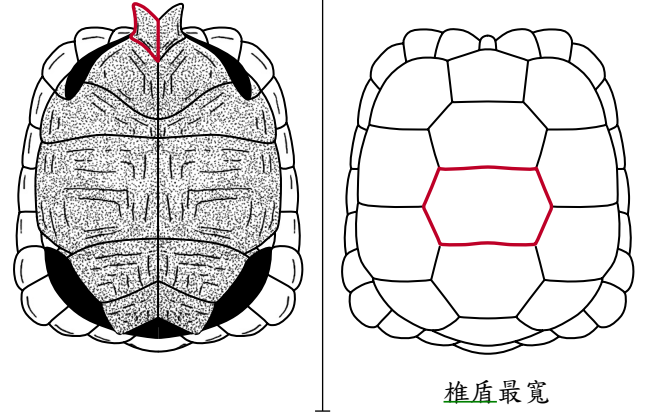

椎盾最寬

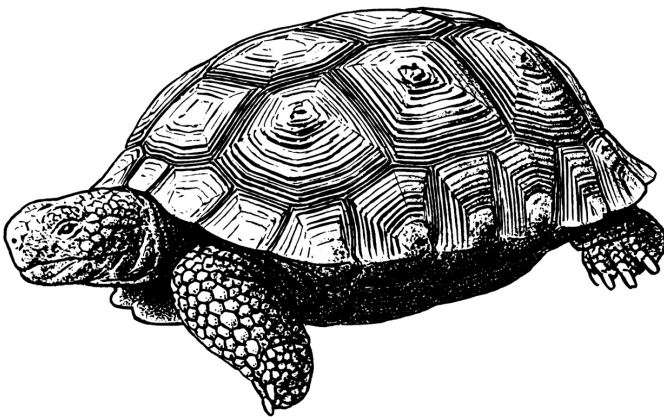

 *Gopherus agassizii*

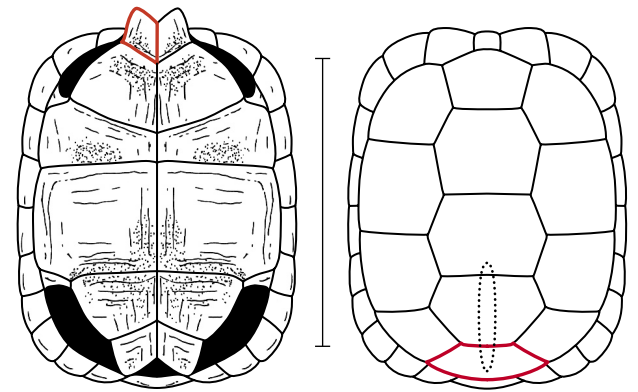



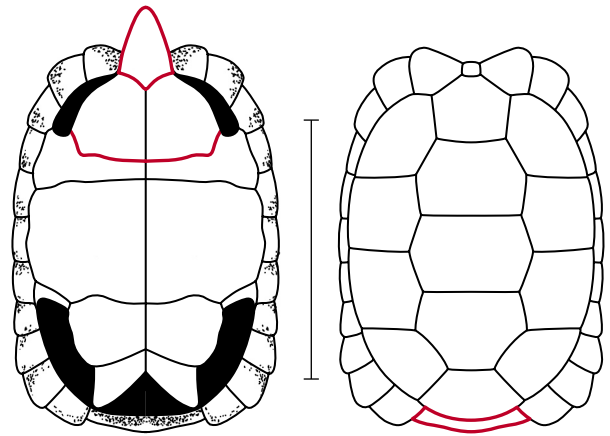
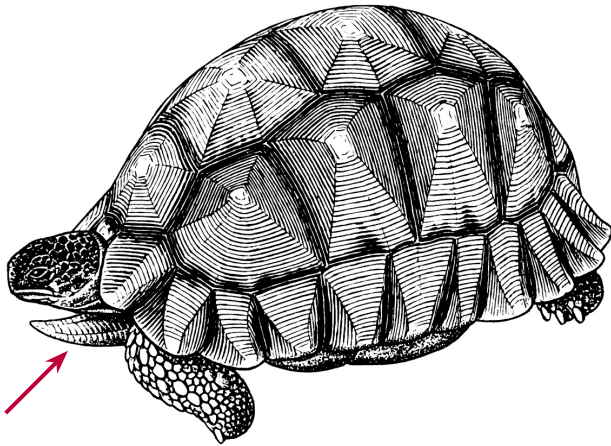

椎盾最寬

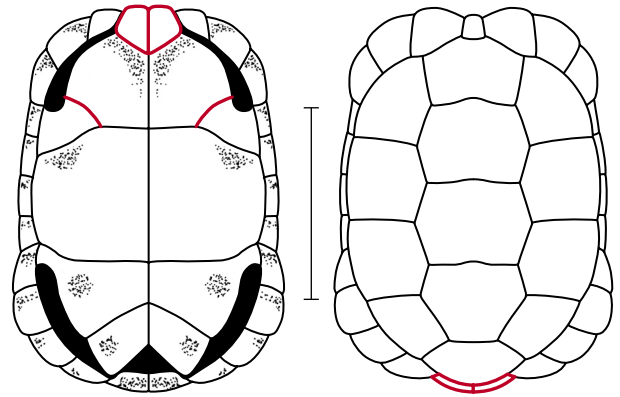
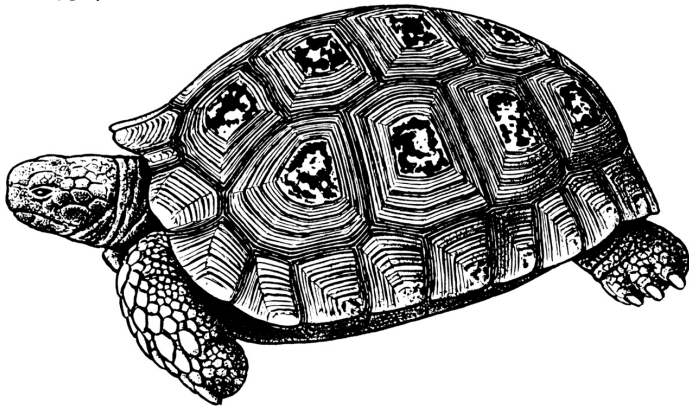

 *Geochelone yniphora*

隨年齡增長，背甲顏色
變為一致



 *Manouria emys*  



隨年齡增長，背甲顏色變為一致

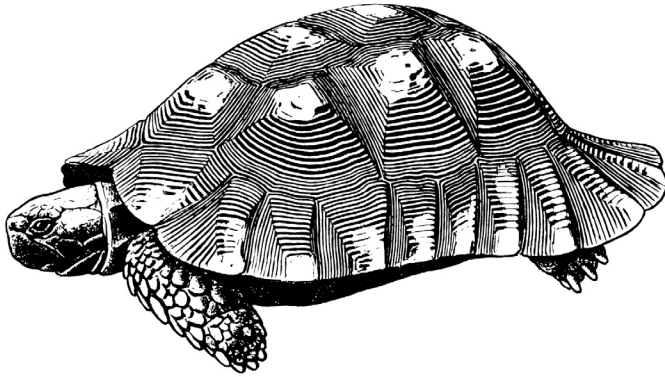

 Testudo marginata

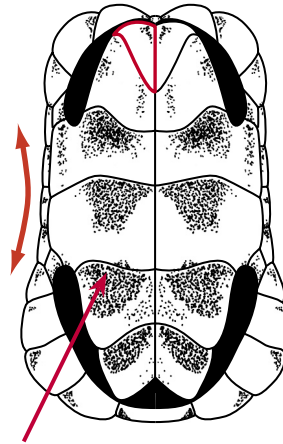

 成體具有韌帶構造

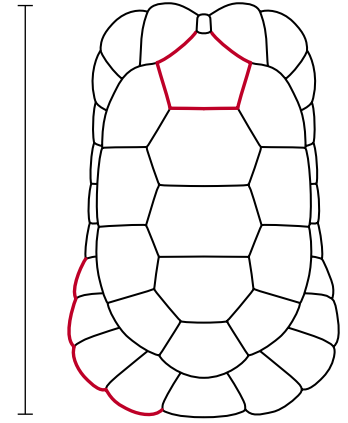

幼體的背甲呈顏色一致

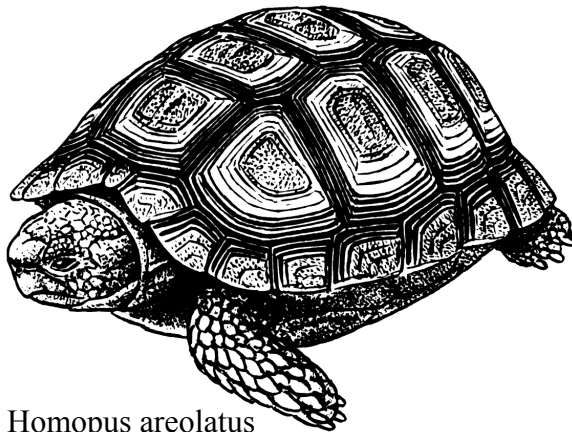

 Homopus areolatus

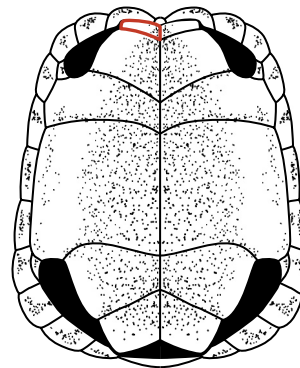

幼體具有稜脊

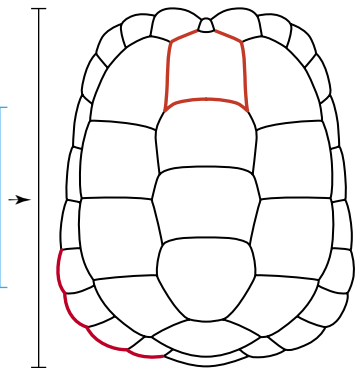



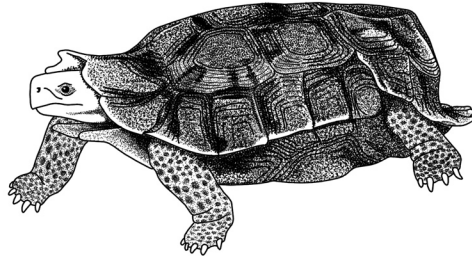

下列種類的成體或幼體
亦可能出現斑點

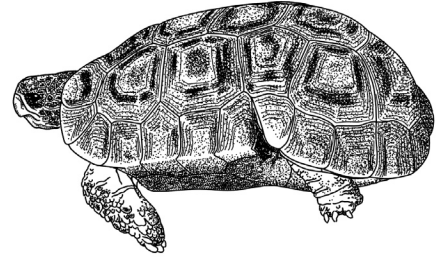

 *Kinixys homeana* (幼體) 5



 *Kinixys belliana* 5

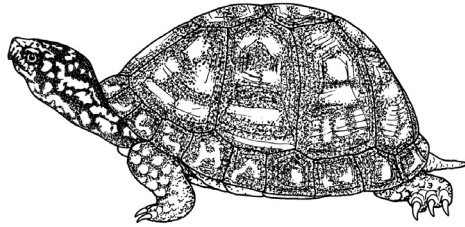

 *Terrapene carolina* (澤龜科) 43

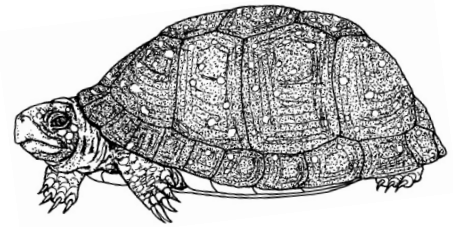

 *Terrapene nelsoni* (澤龜科) 44

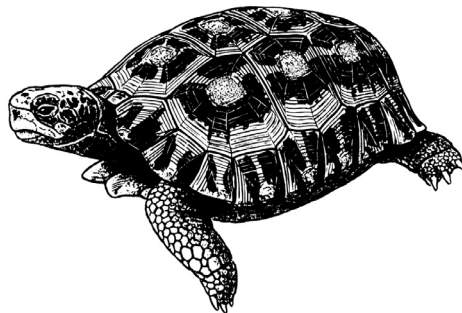

 *Pyxis planicauda* 18

陸龜 Land-dwelling Tortoises 背甲具棕色或黑色斑點 (或斑紋)



Testudinidae 象龜科 : 40 Spp. I 或 II 0 Sp.

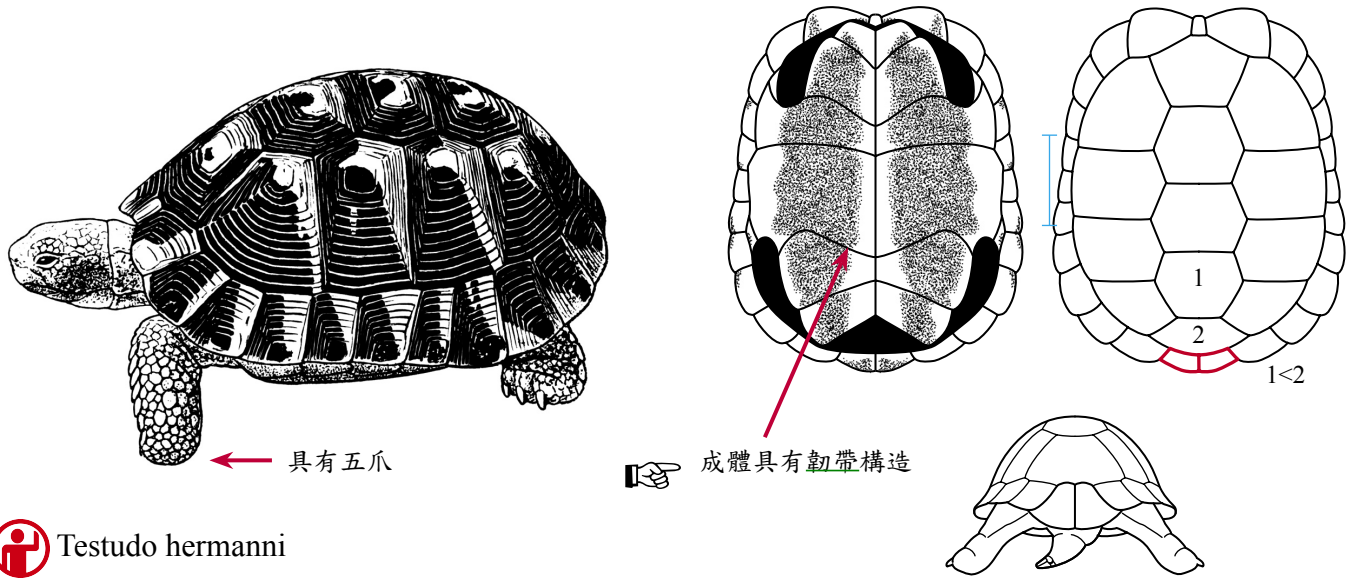

Testudo hermanni

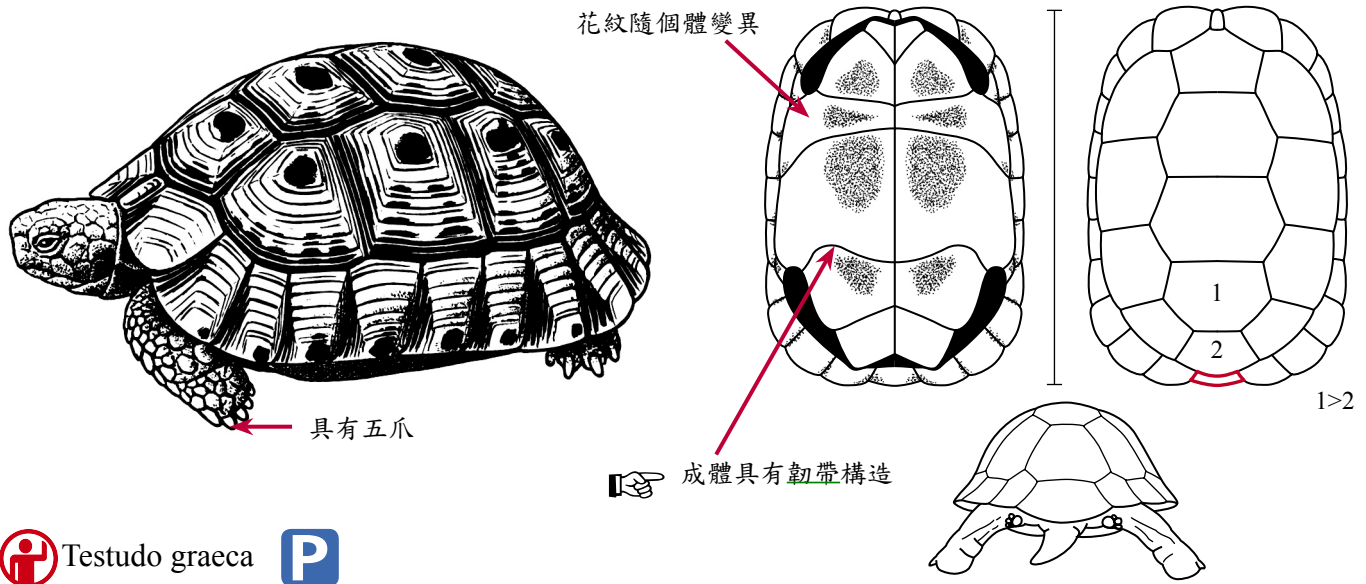

Testudo graeca

陸龜 Land-dwelling Tortoises 背甲具棕色或黑色斑點（或斑紋）

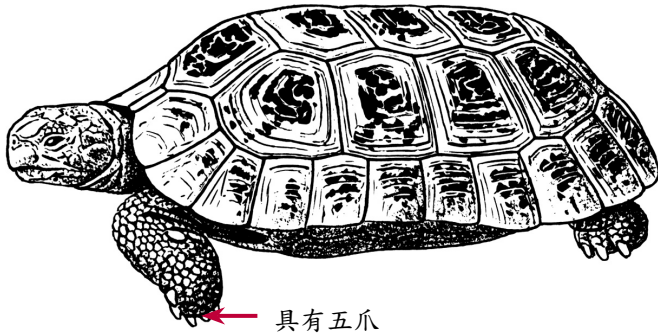

具有五爪

 Indotestudo elongata

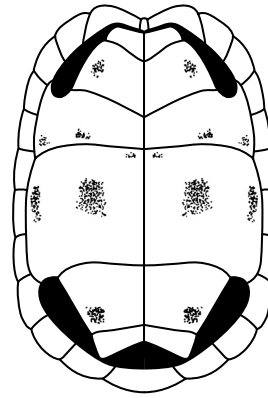

不具韌帶構造

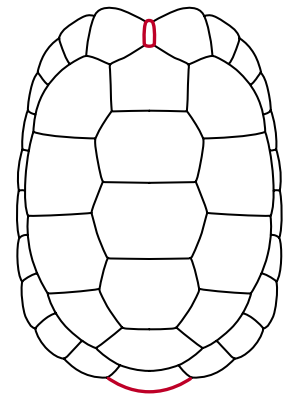

幼體呈鋸齒狀

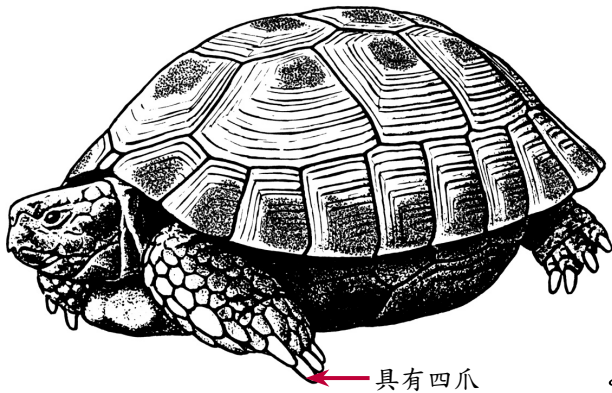

具有四爪

 Testudo horsfieldii

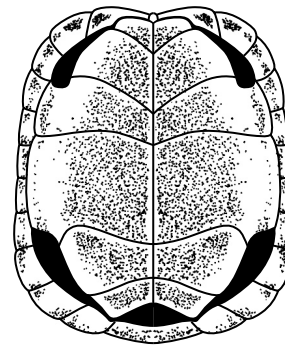

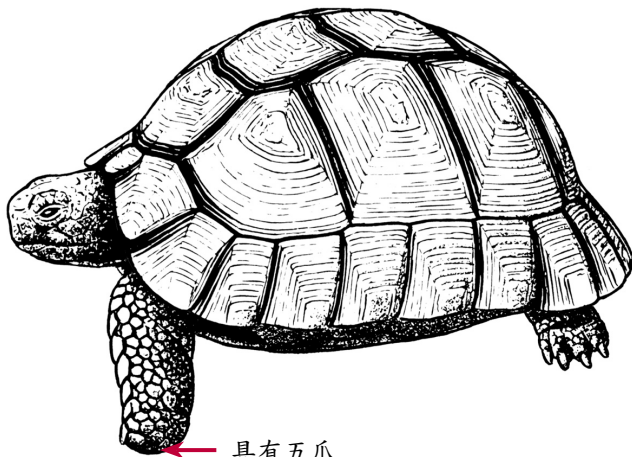
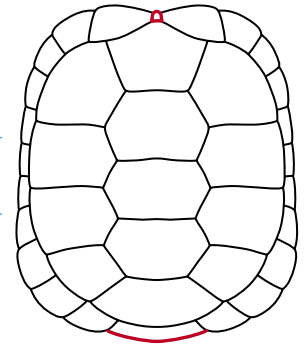

不具韌帶構造

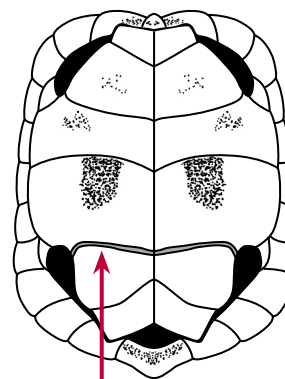

具有五爪

 Testudo kleinmanni



 成體具韌帶構造

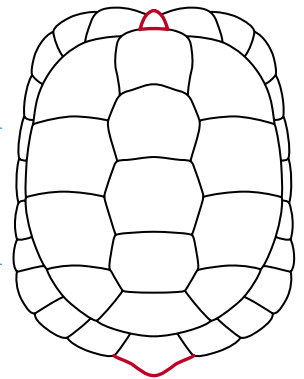

陸龜 Land-dwelling Tortoises 背甲具棕色或黑色斑點（或斑紋）

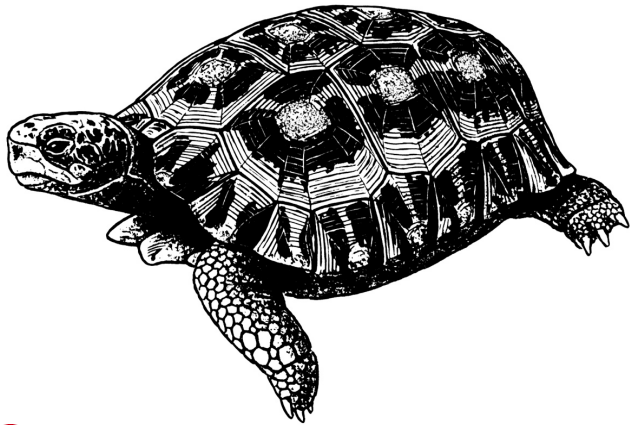

 *Pyxis planicauda*

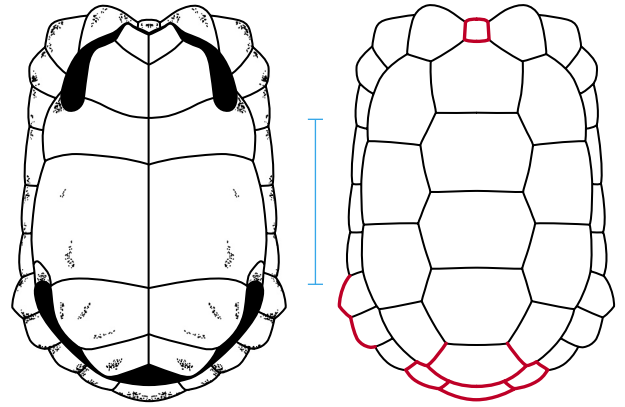

 具有二塊呈鋸齒狀緣盾

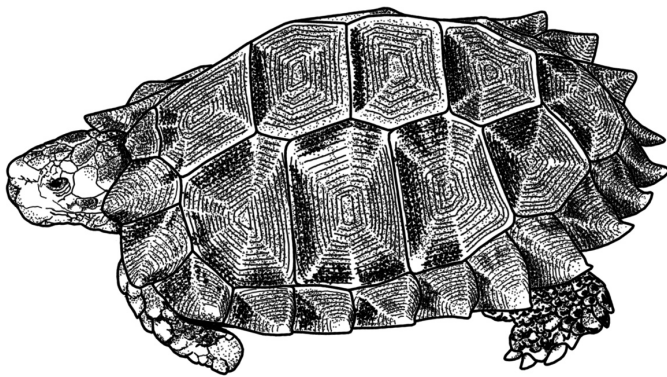

 *Manouria impressa*  

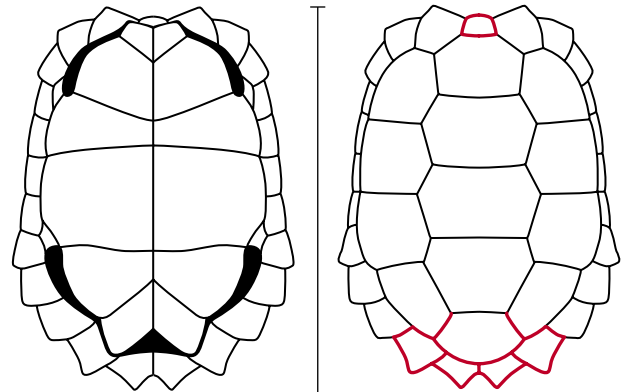

有些個體具鋸齒狀突起，部分則無

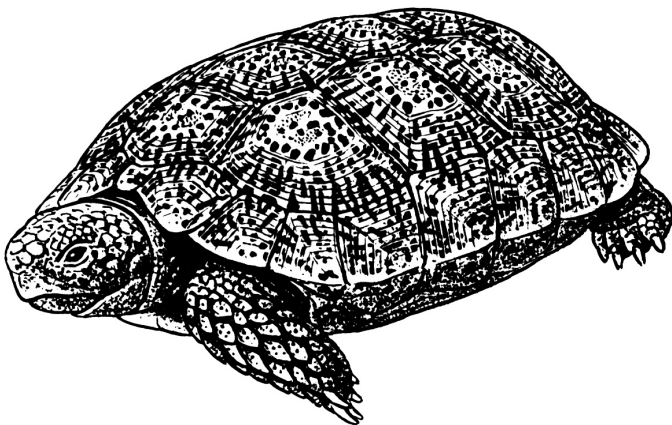

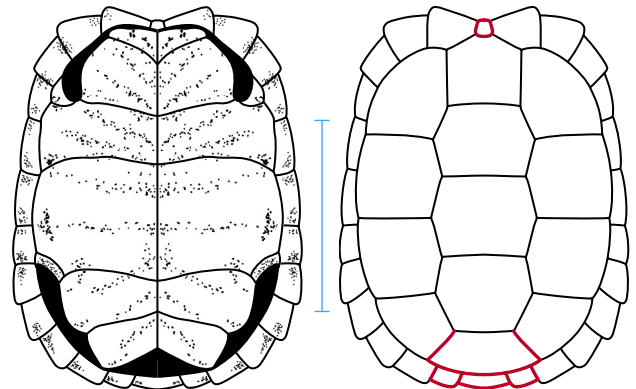

 *Homopus signatus*



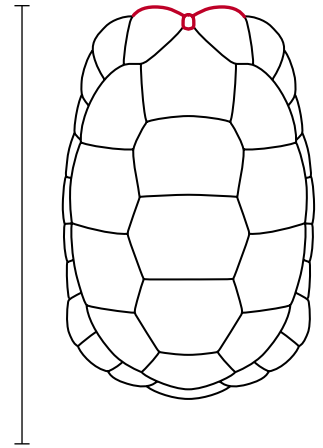
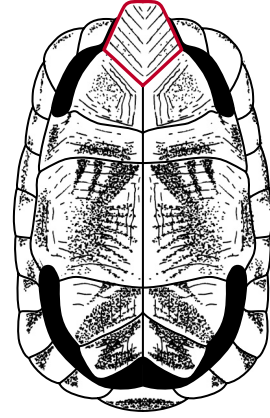
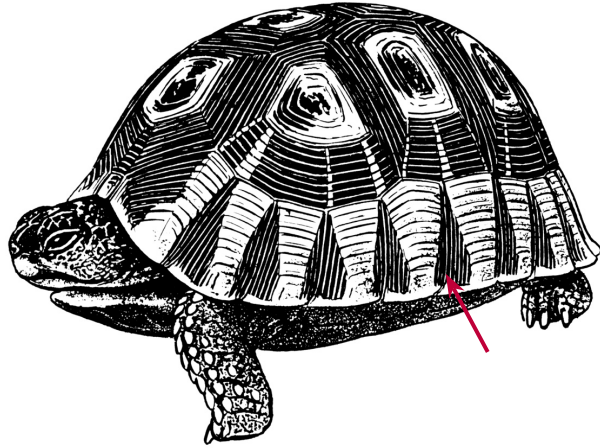

幼體具有稜脊

陸龜 Land-dwelling Tortoises 背甲具棕色或黑色斑點 (或斑紋)

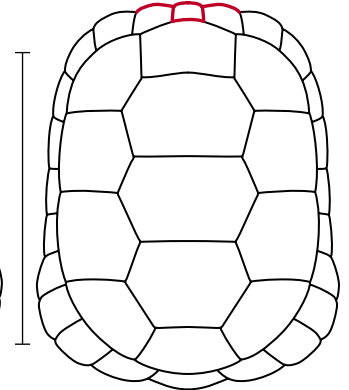
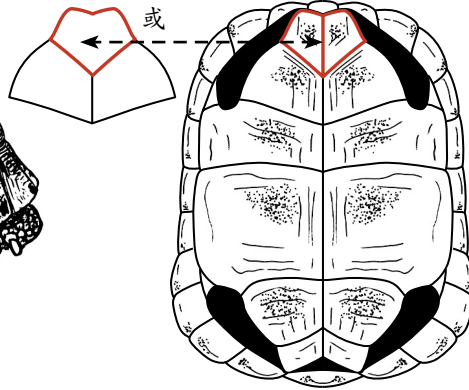
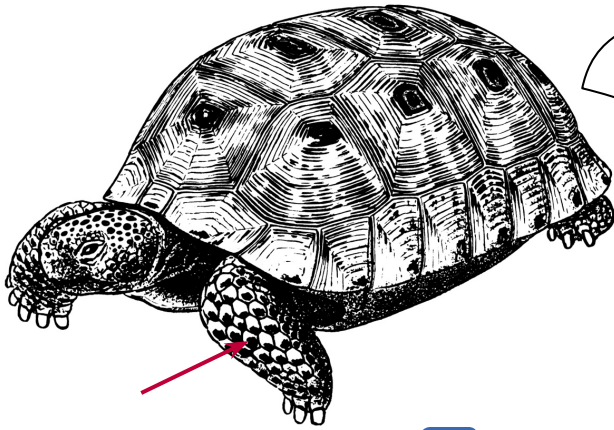

 *Chersina angulata*



 *Gopherus flavomarginatus* 



下列種類的成體或幼體
亦可能出現斑點

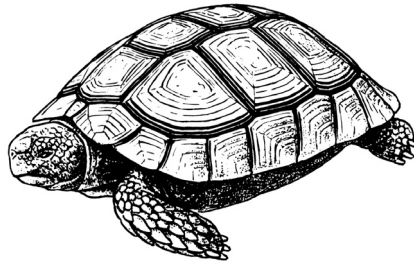

 *Homopus femoralis* (juv.) 3

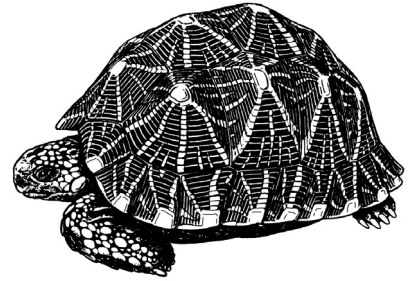

 *Geochelone elegans* (juv.) 5

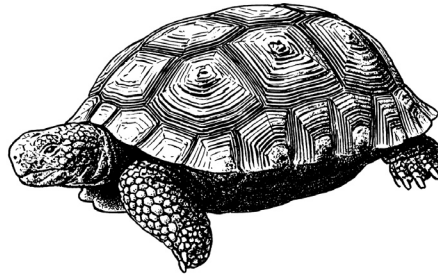

 *Gopherus agassizii* 3

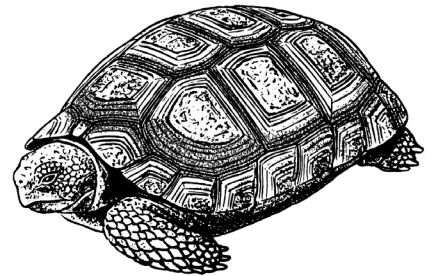

 *Homopus boulengeri* 5

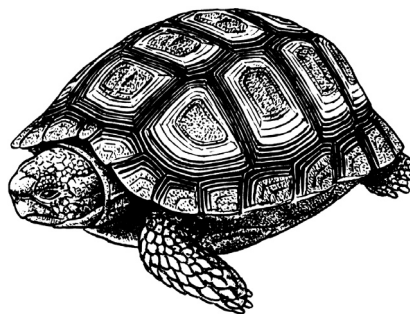





 *Homopus areolatus* 3

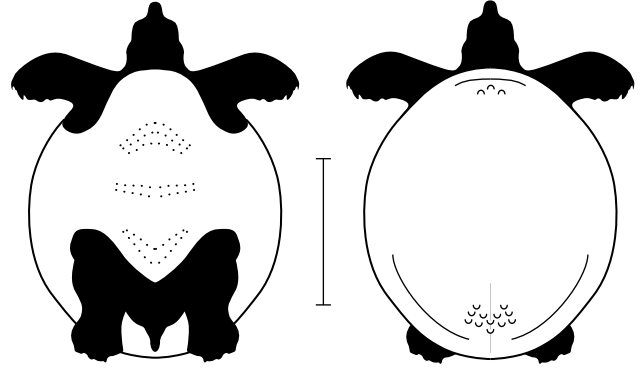
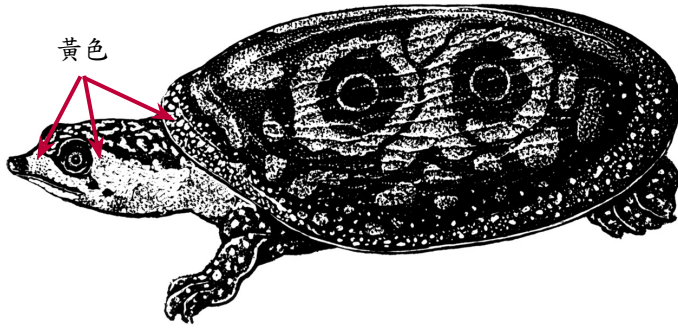

Trionychidae 鰲科： 6 Spp. I, II 或 III 17 Spp.

具有四至六塊眼斑







-  *Aspideretes hurum* 
-  *Nilssonia formosa**

**N. formosa* 鼻端上方並無黃色斑點

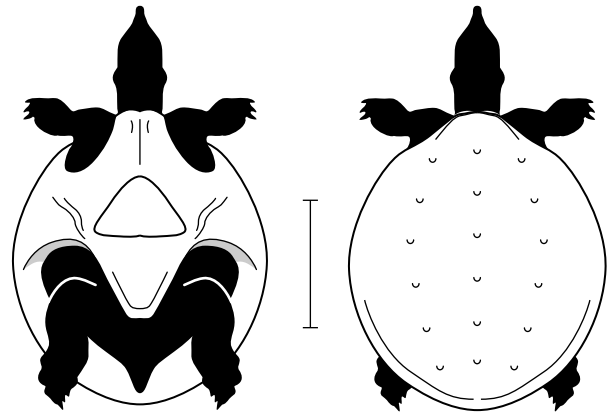
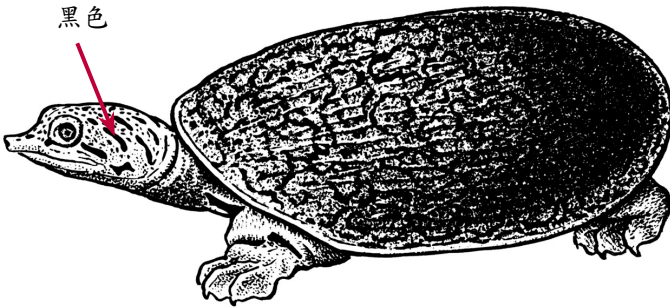
幼體具有疣凸

黑色



-  *Aspideretes gangeticus*  
-  *Aspideretes leithii**

**A. leithii* 背甲前段具有疣凸

幼體具成排疣凸及四塊眼斑

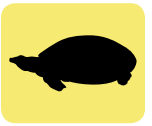

橄欖色

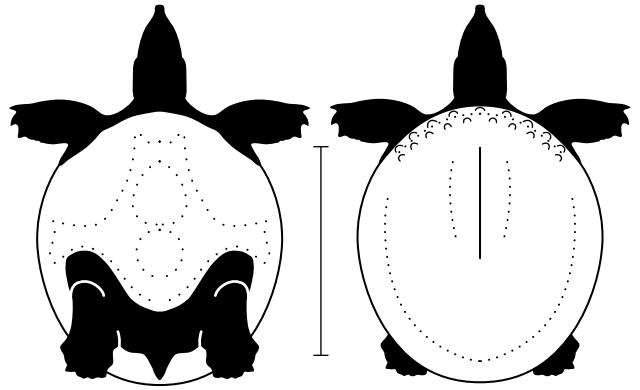

Rafetus euphraticus



幼體具成排疣凸及淺色斑點

橄欖色

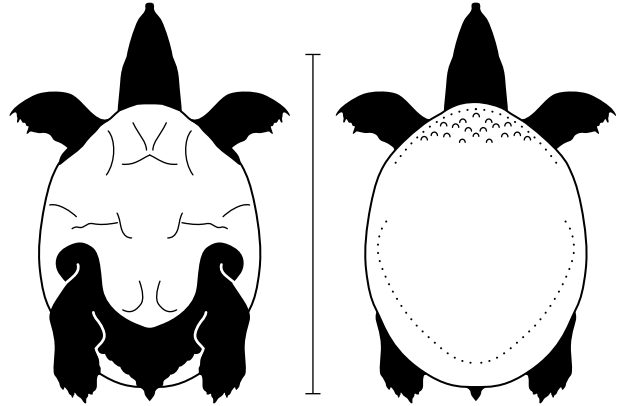
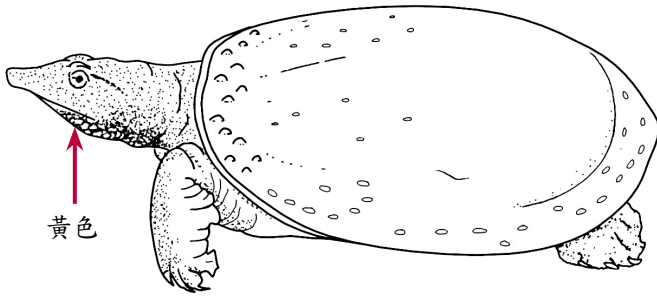

Pelodiscus sinensis



幼體具成排疣凸及黑色斑點

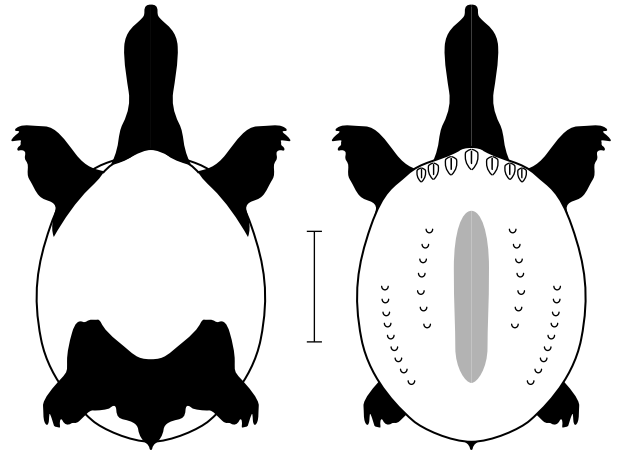
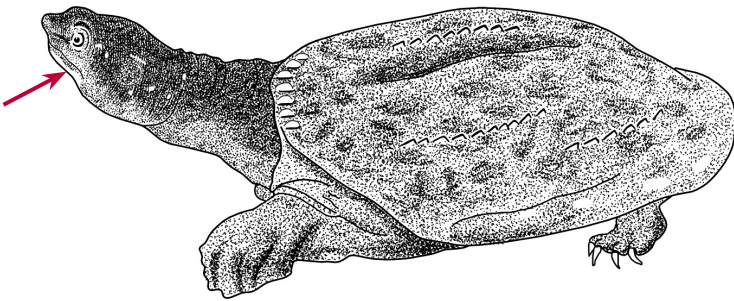

Aspiredetes nigricans



頭部呈橄欖色至棕色並間有黑色斑點

棕色

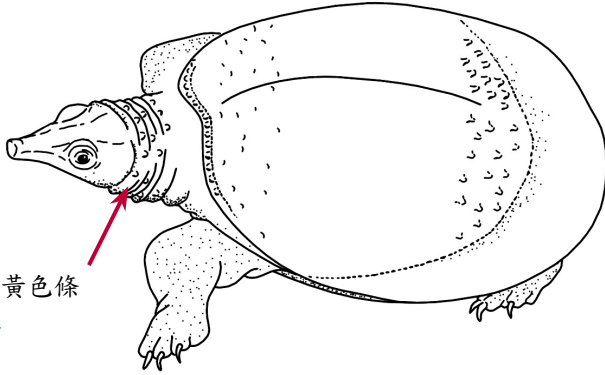

頭部具有黃色條紋及疣凸

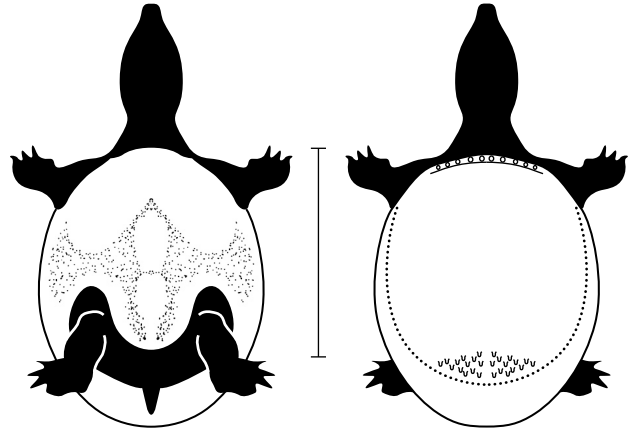

幼體具有成排疣凸



Palea steindachneri

黃色細點

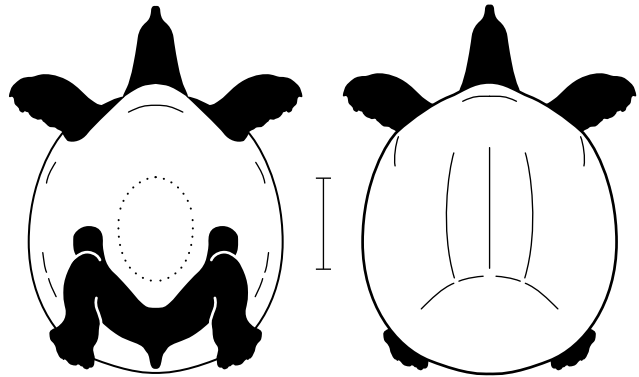
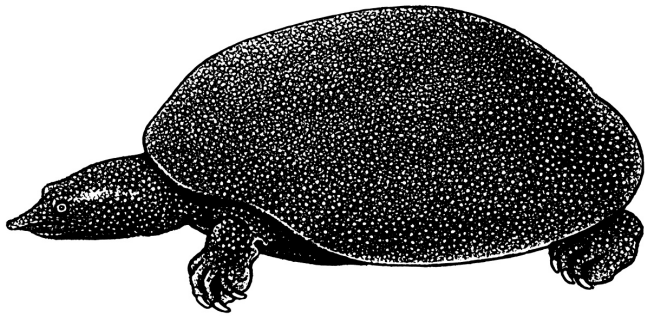

幼體具有成排疣凸



Trionyx triunguis



頭部呈橄欖色間有黃色斑點

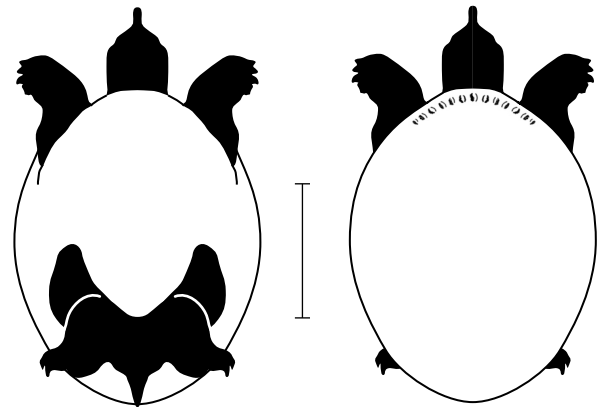
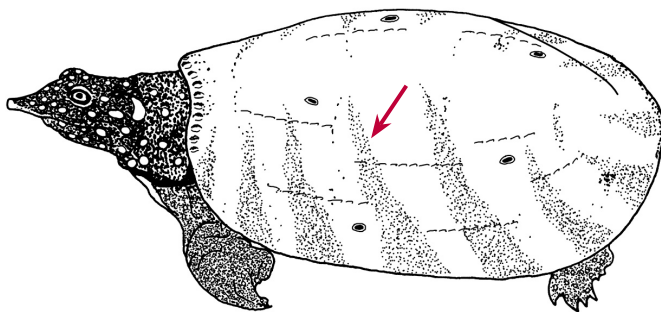

幼體具有成排疣凸及黑色斑點



Amyda cartilaginea



*Nilssonia formosa**



**N. formosa* 於頭部具有黃色鑲深色邊的斑點

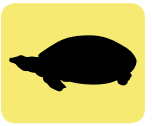

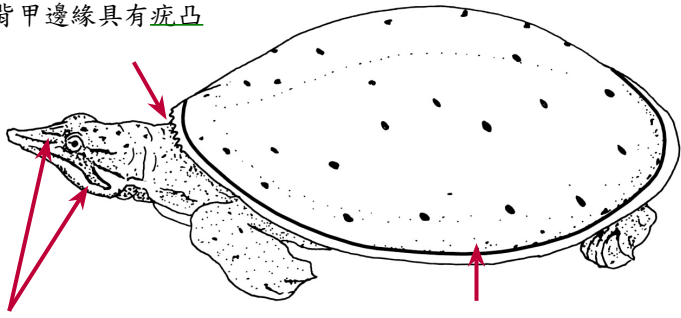

背甲邊緣具有疣凸

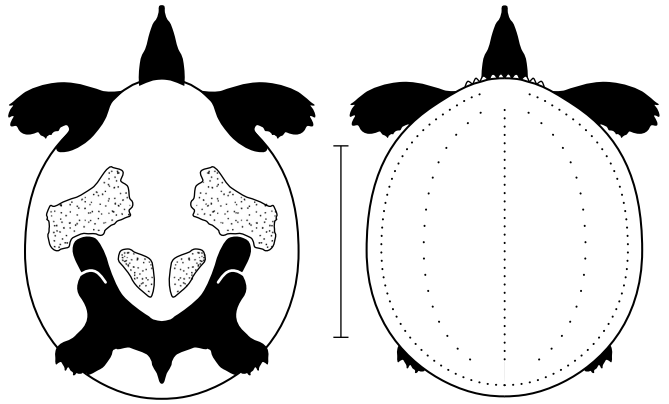

二道鑲有黑邊的淺色條紋

裙邊顏色較淺



 *Apalone spinifera spinifera*

 *Apalone spinifera ater**

**A. spinifera ater* 呈深灰色（頭部及背甲），背甲邊緣僅見有小型疣凸

幼體眼睛後方具有紅色斑點

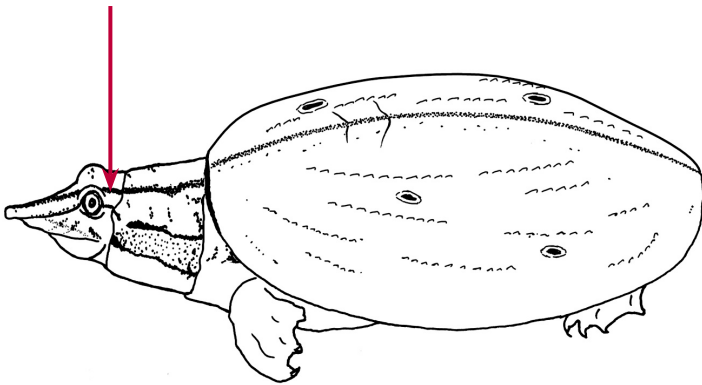

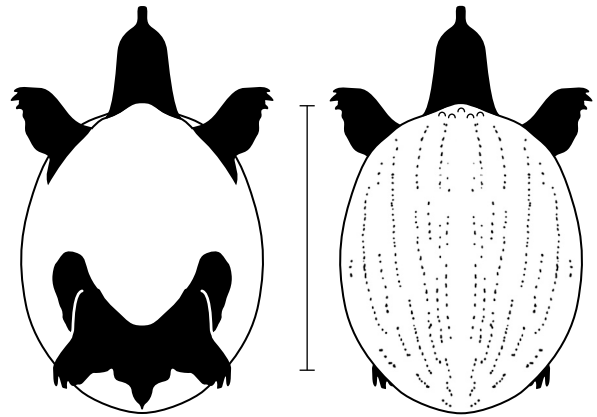

 *Dogania subplana*

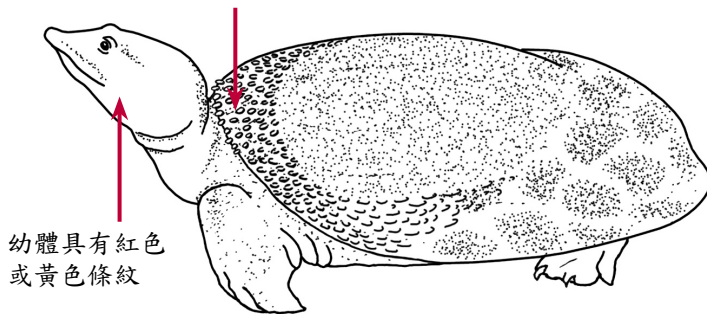

成排疣凸



幼體具有紅色或黃色條紋

 *Apalone ferox* 

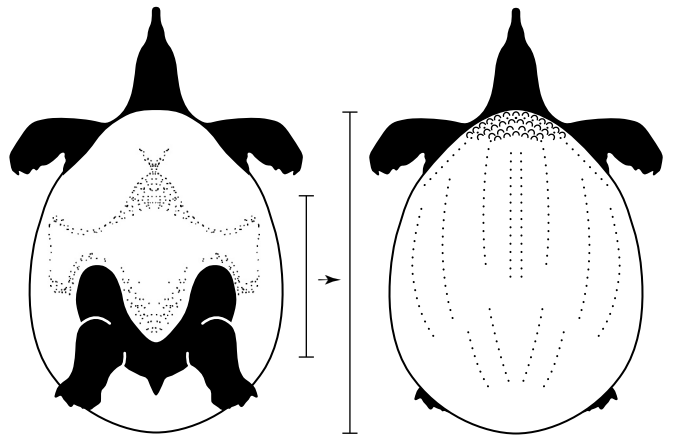

成排疣凸



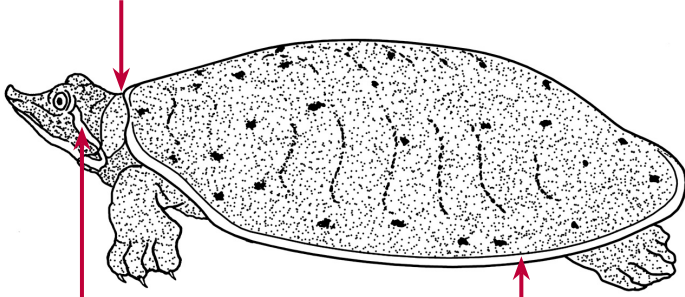

邊緣不具有疣凸

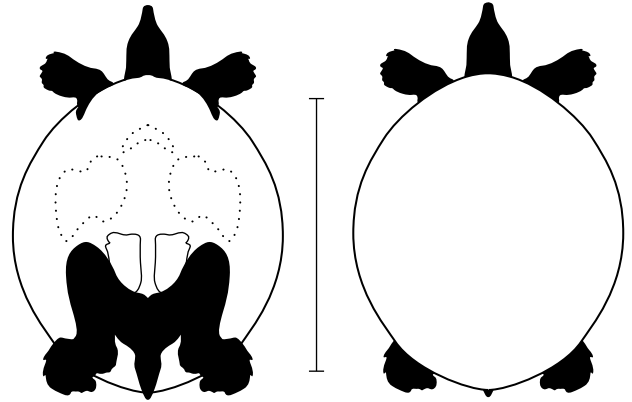

一道鑲有黑邊的淺色條紋

裙邊呈黃色



 *Apalone mutica*

鑲深色邊的黃色條紋

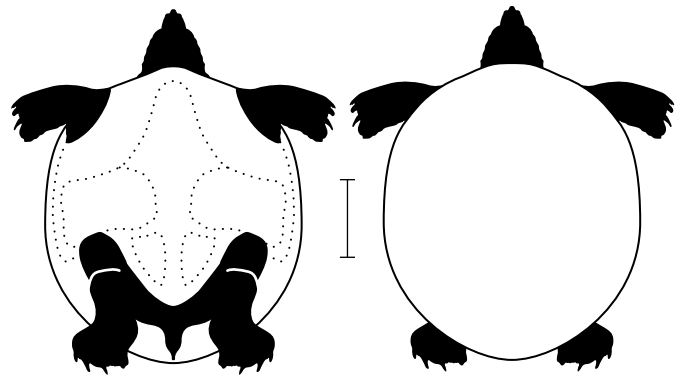
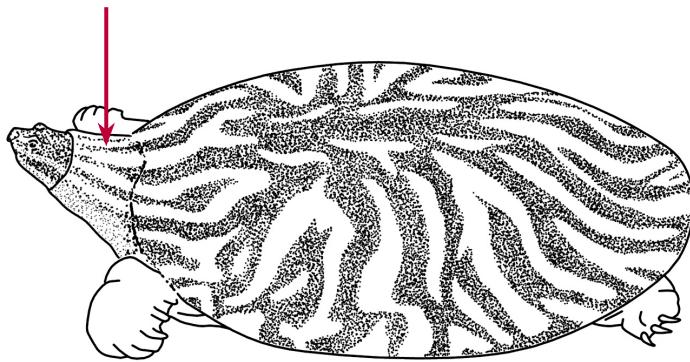

幼體具有稜脊、疣凸及四塊眼斑

 *Chitra indica*



深色斑點

花紋隨個體而異

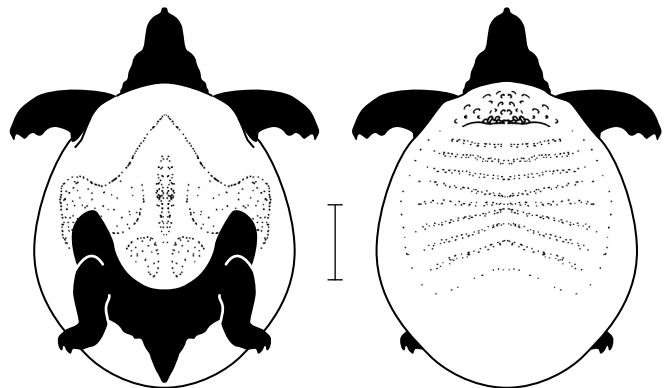
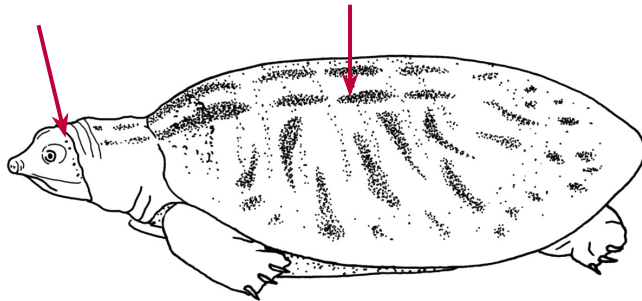

幼體具有黑色小斑點

幼體具有稜脊及疣凸

 *Pelochelys bibroni*





Chelidae 蛇頸龜科：👤 1 Sp. I 👤 39 Spp.

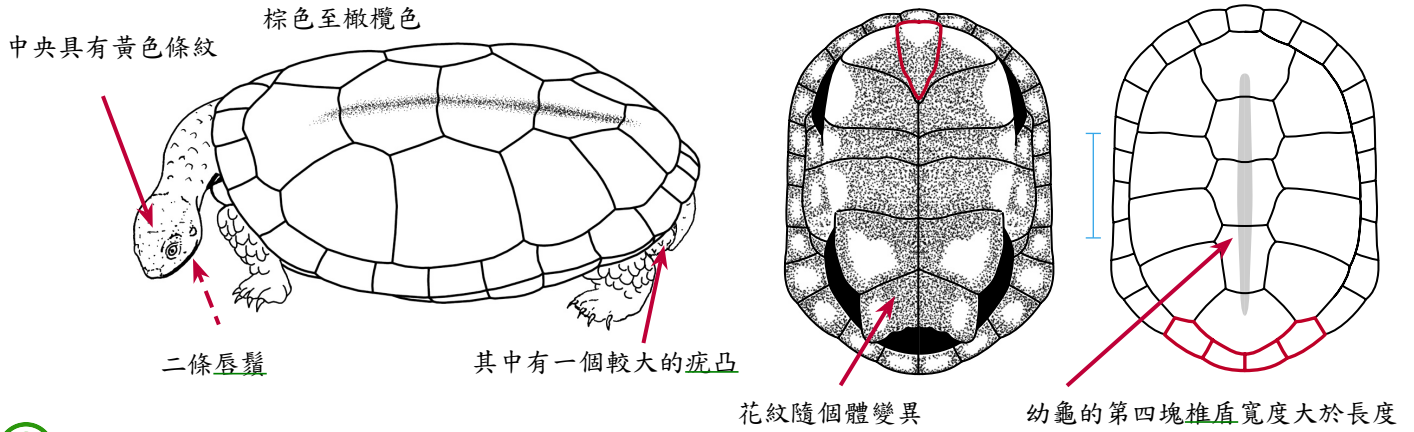

👤 *Acanthochelys pallidipectoris*

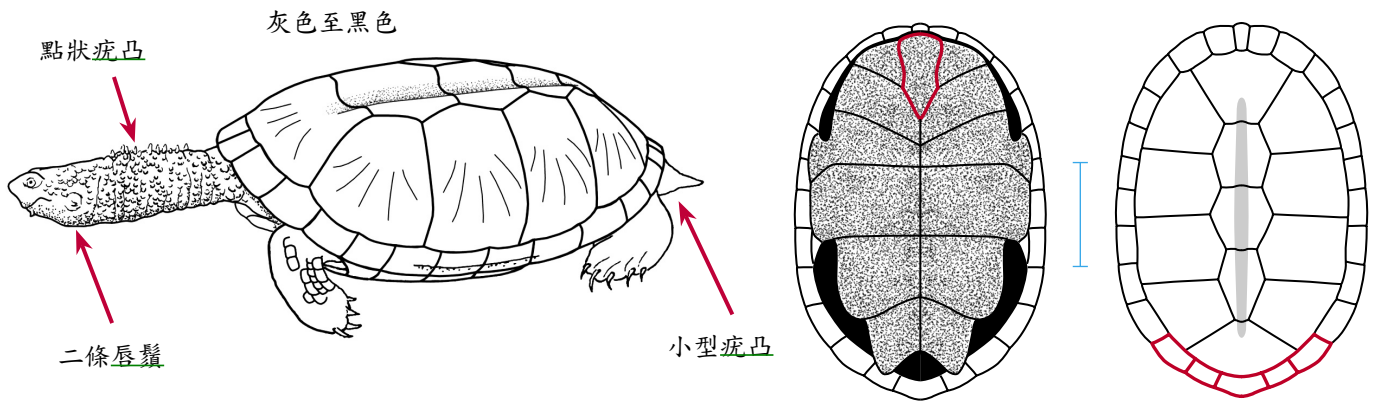

👤 *Acanthochelys spixii*

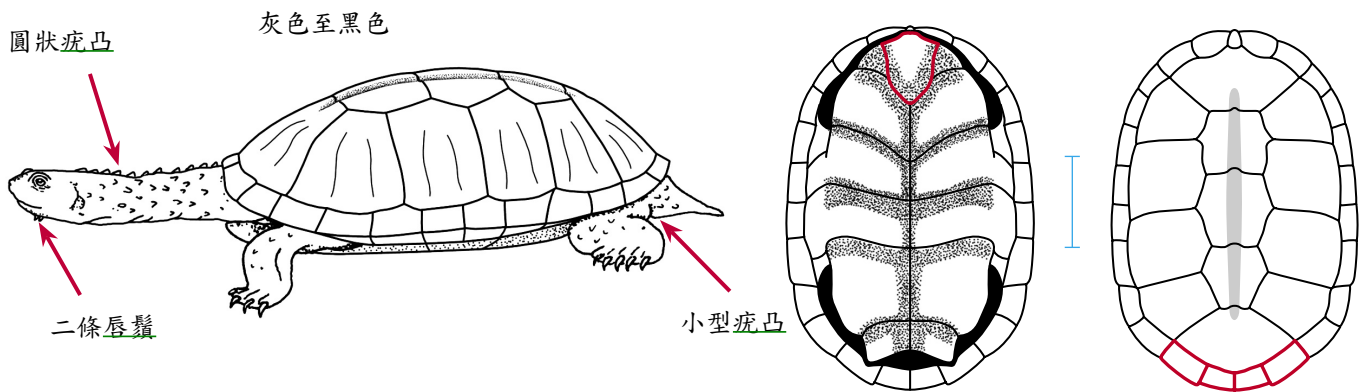

👤 *Acanthochelys radiolata*



灰色

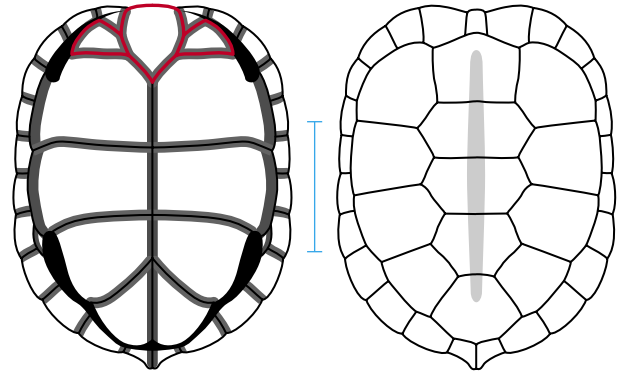
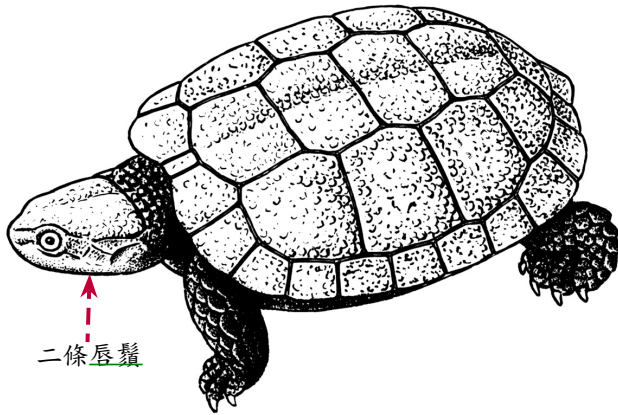



 *Pseudemys umbrina*

頭部背側呈黃色至橘色

內凹極深

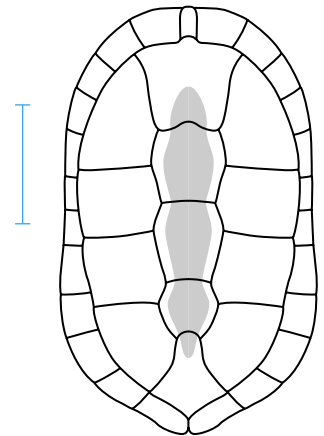
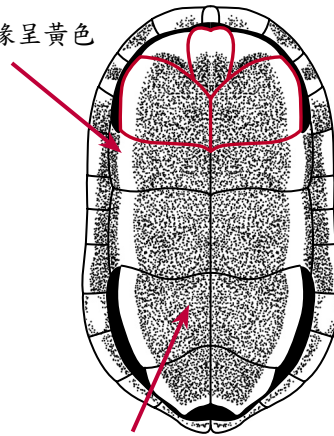
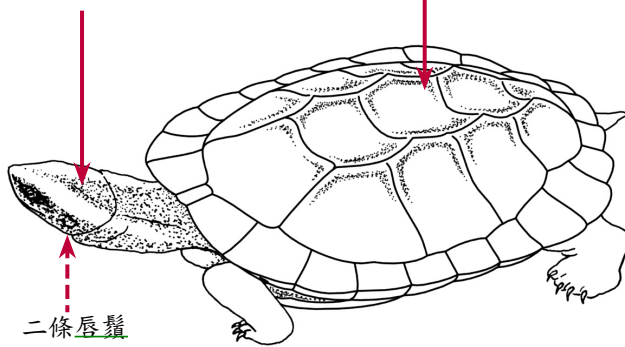
 邊緣呈黃色



 *Platemys platycephala*

幼體為黃色

幼體的椎盾寬度大於長度



不具鑲黑色邊的淺色條紋

棕色

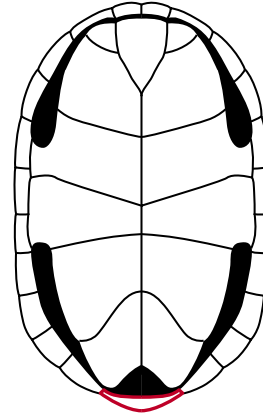
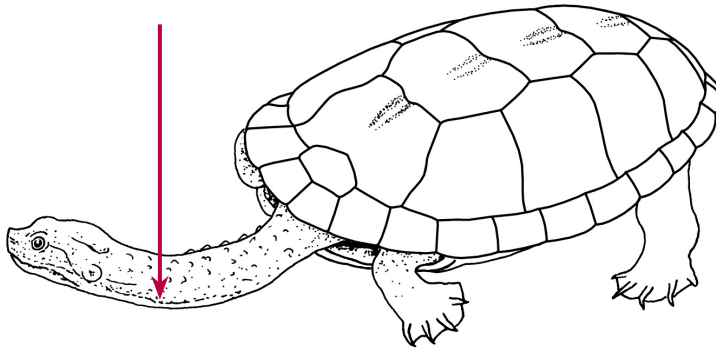

具有頸盾

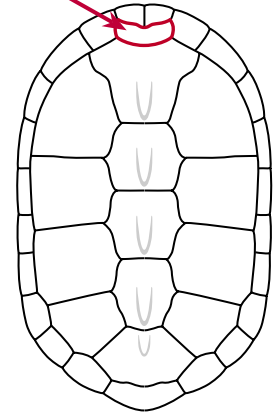

Hydromedusa maximiliani

幼體

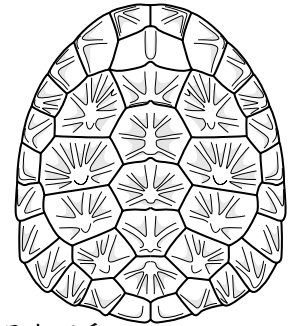
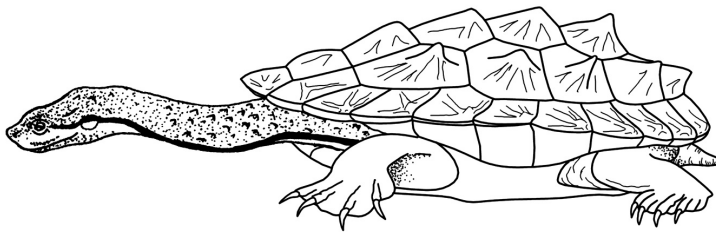

具有鑲黑色邊的淺色條紋

棕色

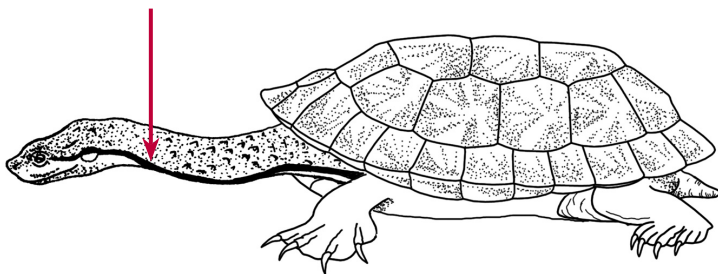

具有頸盾

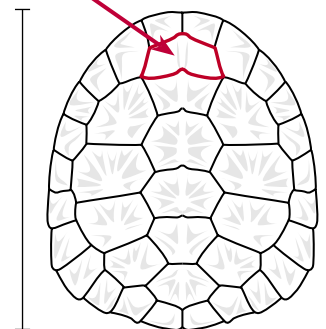

成體

Hydromedusa tectifera



年齡大的個體背甲為黑色

常不具頸盾

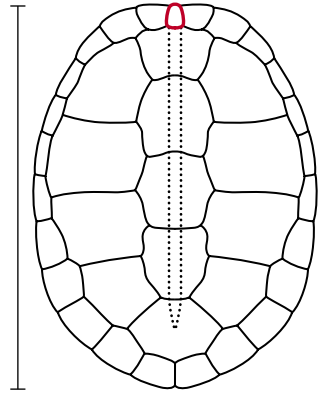
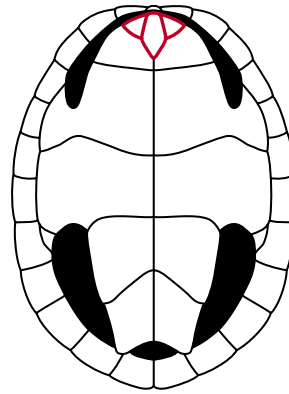
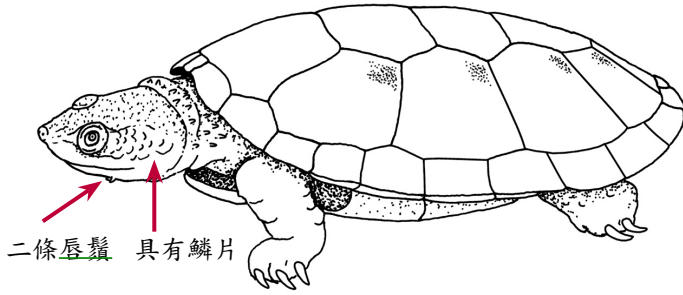

Eseya novaeguineae

呈棕色

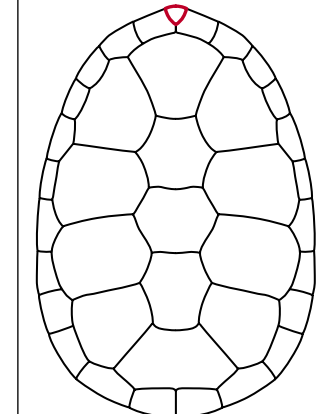
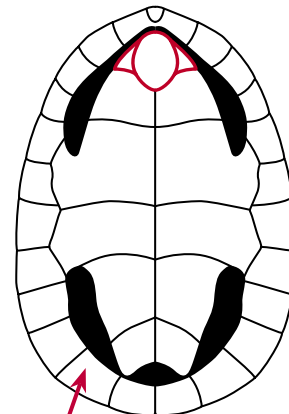
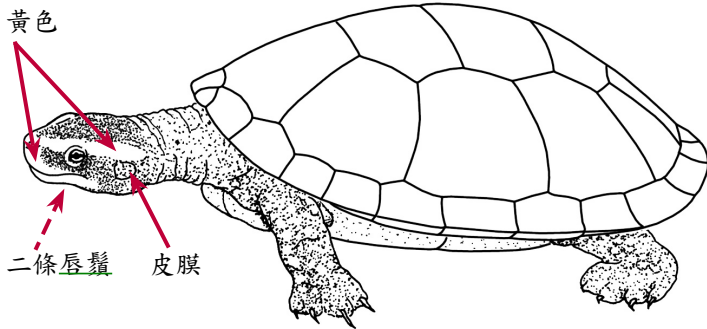

Emydura subglobosa

呈棕色

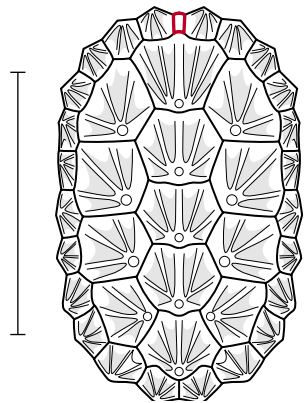
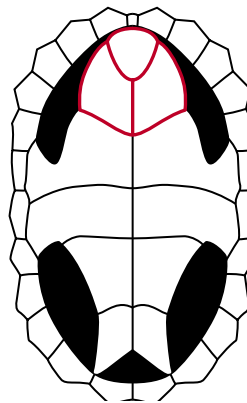
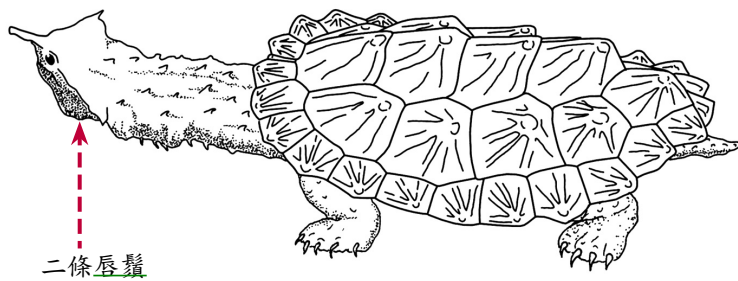

Chelus fimbriata

並參閱 *Dermatemys mawii* 39 的二塊喉盾有時未明顯分離，常被視為間喉盾。



Pelomedusidae 側頸龜科 : 13 Spp. II 或 III 12 Spp.

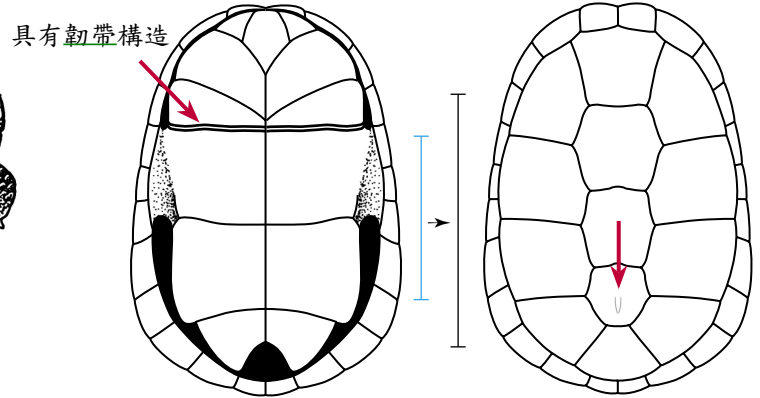
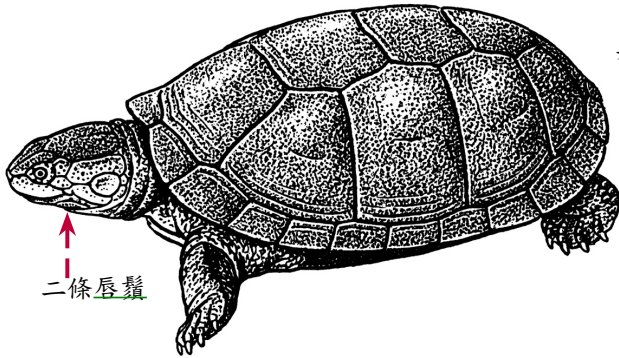

Spp. PE-1-5-8-10 1



Others/autres/otras 1

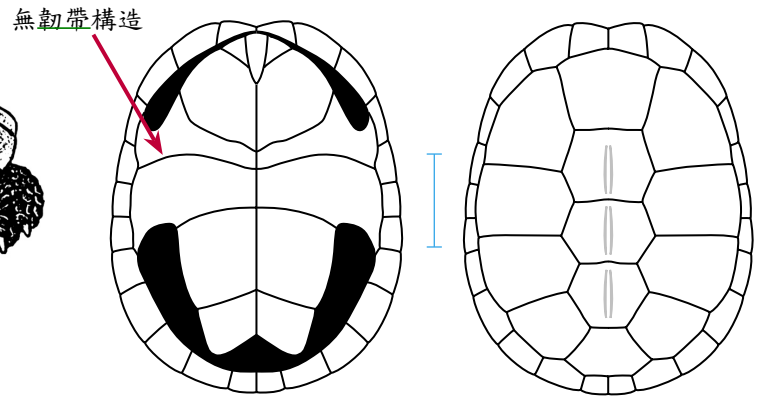
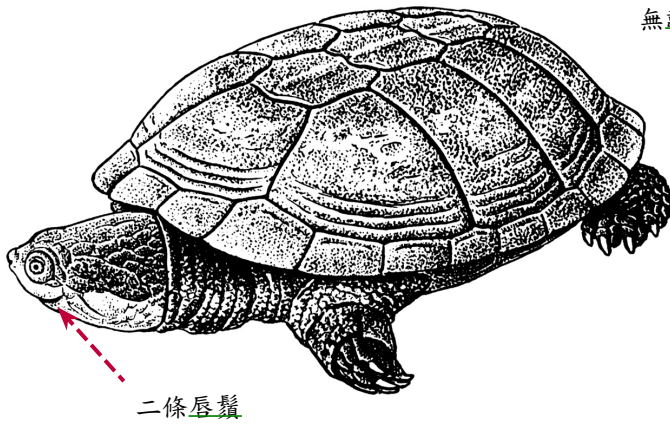

幼體具有花紋

Pelomedusa subrufa

非—美洲側頸龜 Afro-American Side-necked Turtles

後肢具有四爪

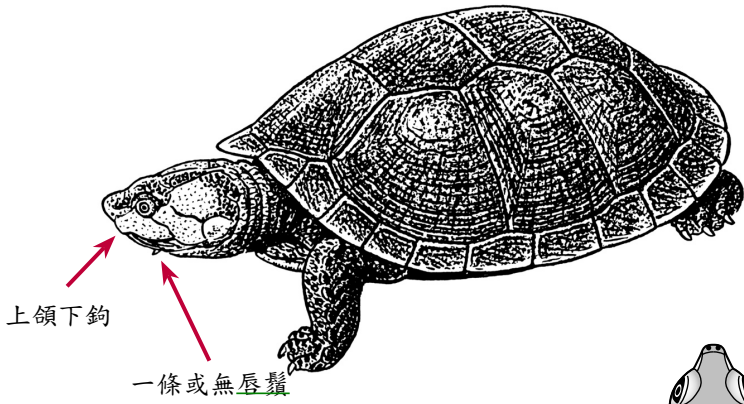
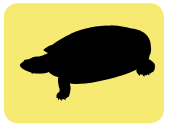

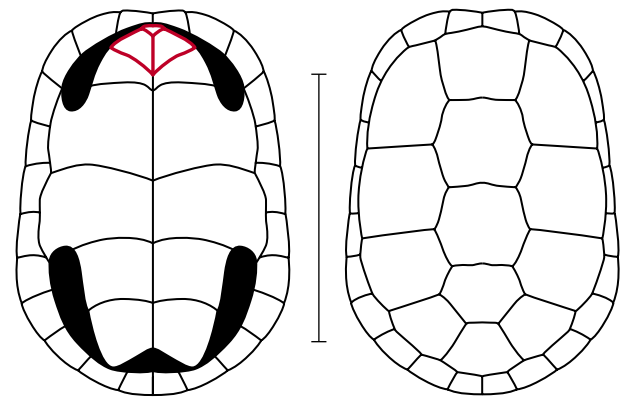
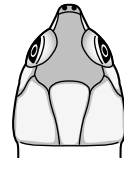

上頷下鈎

一條或無唇鬚



幼體具有花紋

 *Erymnochelys madagascariensis* 

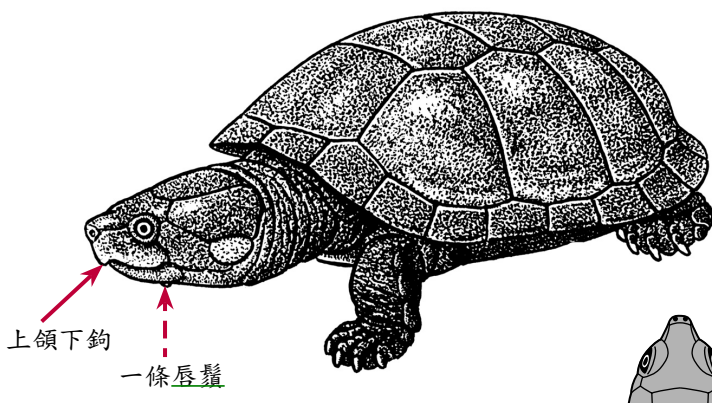

上頷下鈎

一條唇鬚

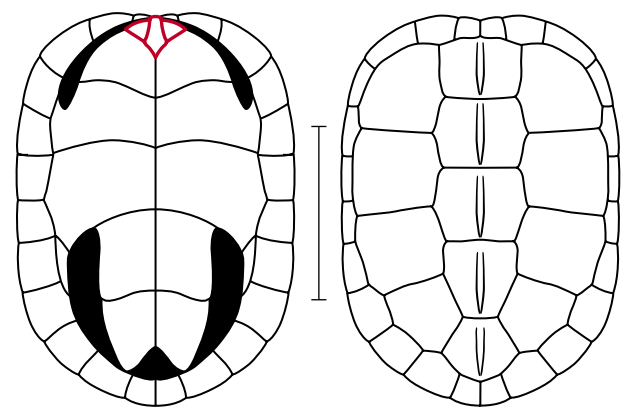
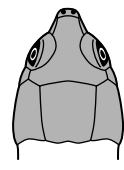

 *Peltocephalus dumerilianus*

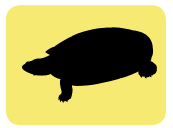

上頷中央有缺口

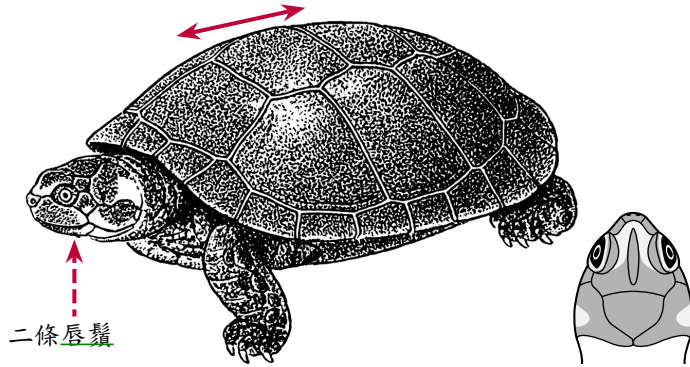

1<2

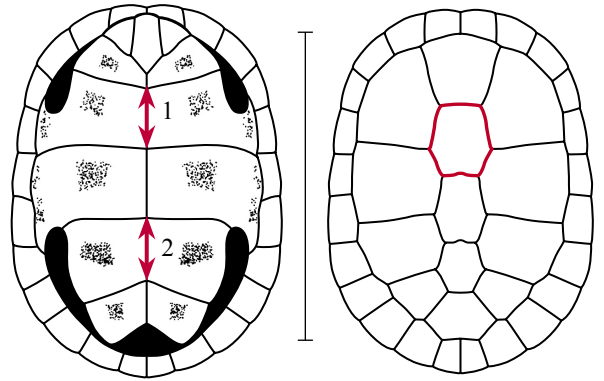

Podocnemis vogli



Podocnemis 幼體具有不明顯的稜脊及寬度大於長度的椎盾

上頷呈直角無缺口

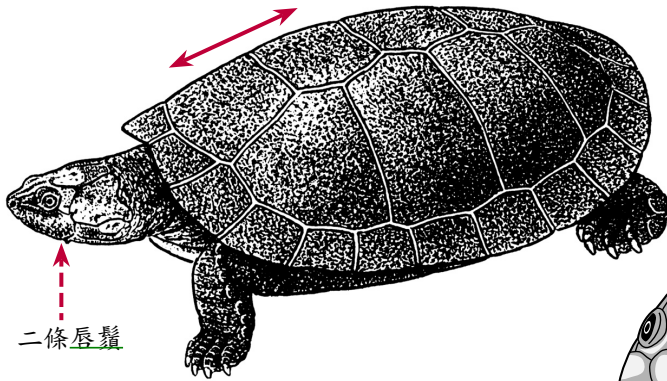

1>2

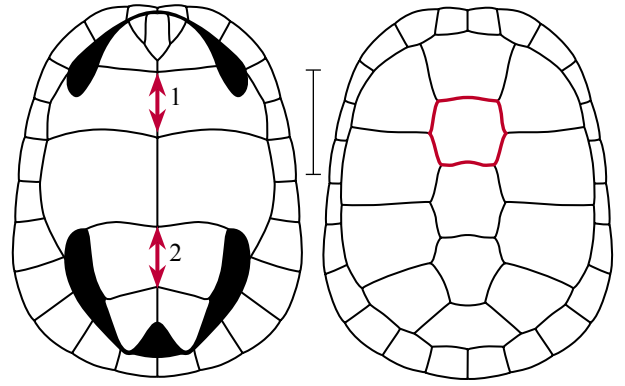

呈黃色或黑色



Podocnemis expansa



上頷圓形無缺口

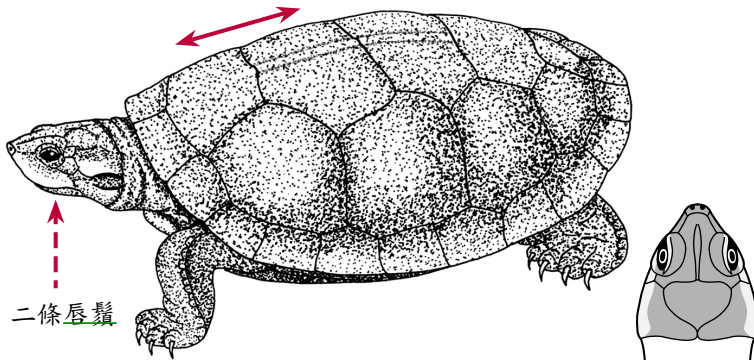

灰色

1>2

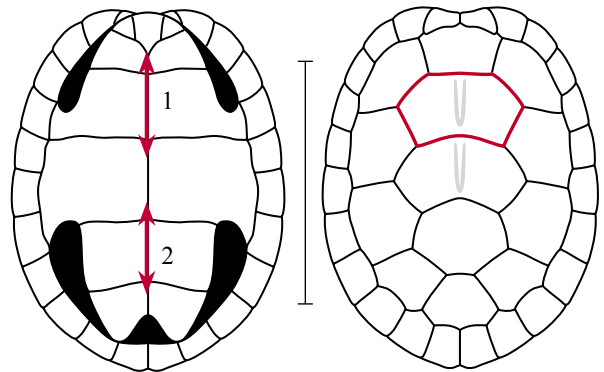

Podocnemis lewyana

P. lewyana 成體及幼體椎盾寬度大於長度

非—美洲側頸龜 Afro-American Side-necked Turtles

後肢具四爪，眼窩間有凹溝



頭部無紅或黃色斑點

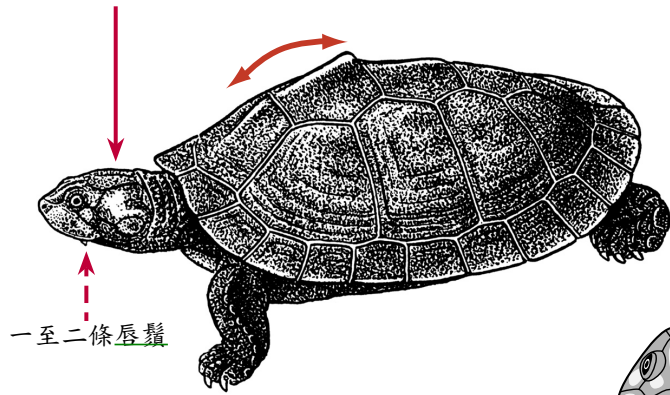

一至二條唇鬚

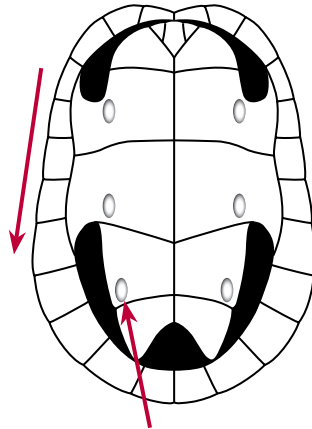
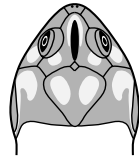

具有六處疣凸

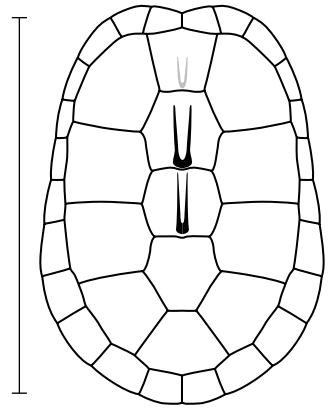

幼體呈鋸齒狀

 Podocnemis sextuberculata

頭部具有黃色斑點（雄龜）

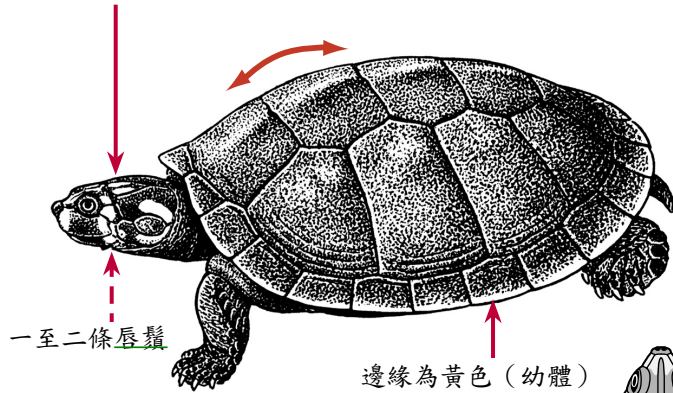

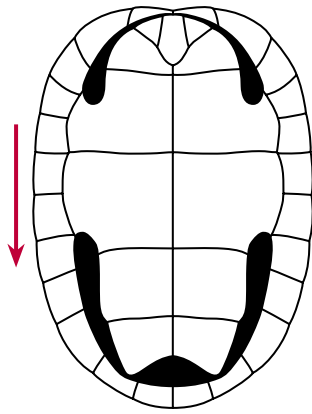
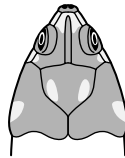

一至二條唇鬚

邊緣為黃色（幼體）

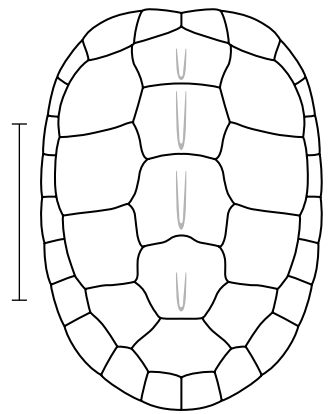

隨年齡增大出現有黑點



 Podocnemis unifilis

頭部具有紅點（雄龜）

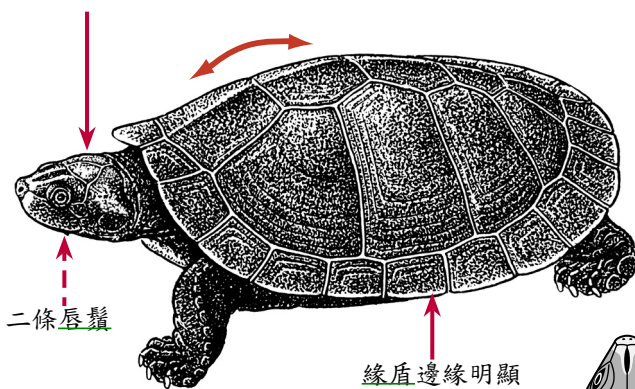

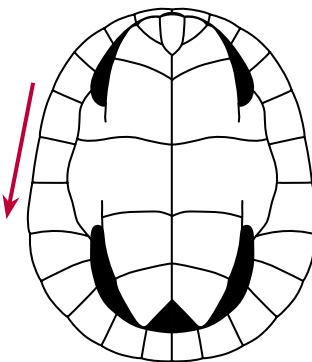

二條唇鬚

緣盾邊緣明顯

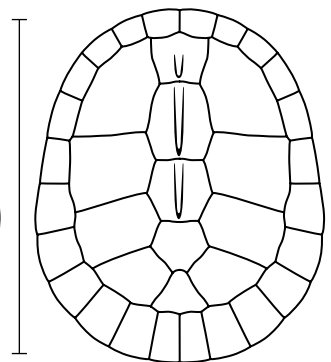

灰色至棕色



 Podocnemis erythrocephala



Kinosternidae 麝龜科：👤 0 Sp. 👤 22 Spp.

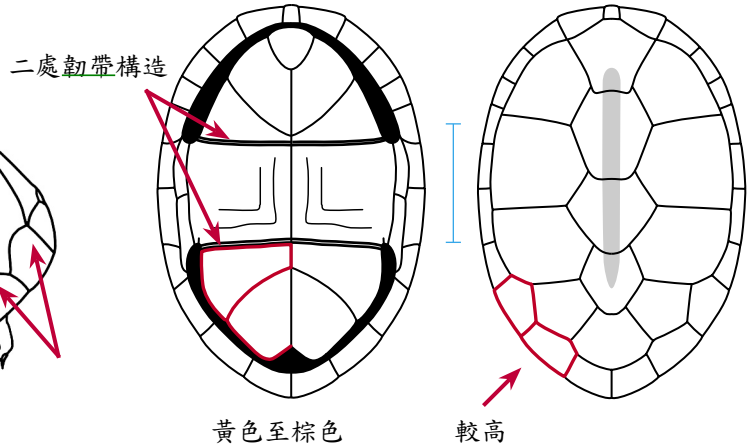
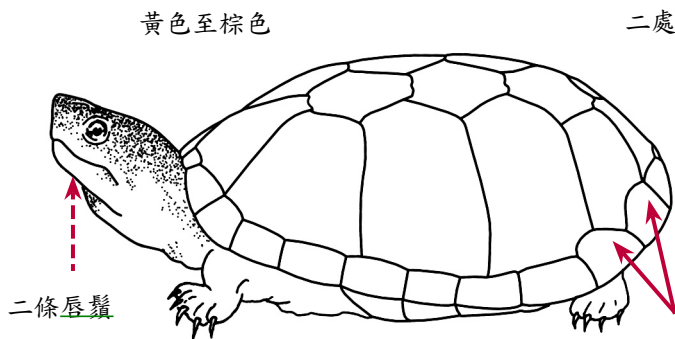

👤 Kinosternon flavescens

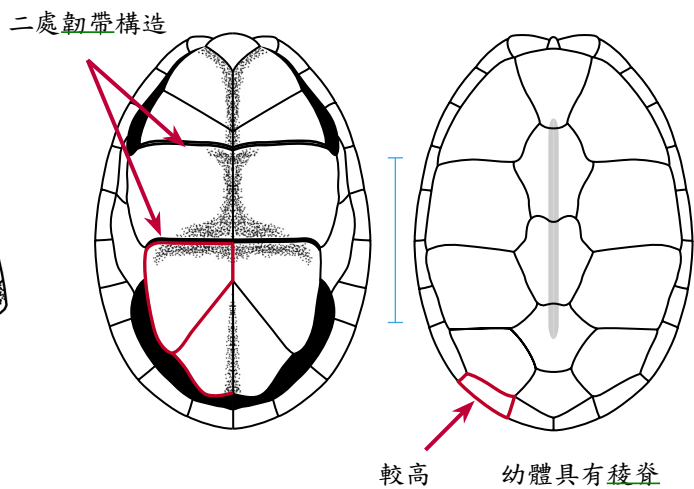
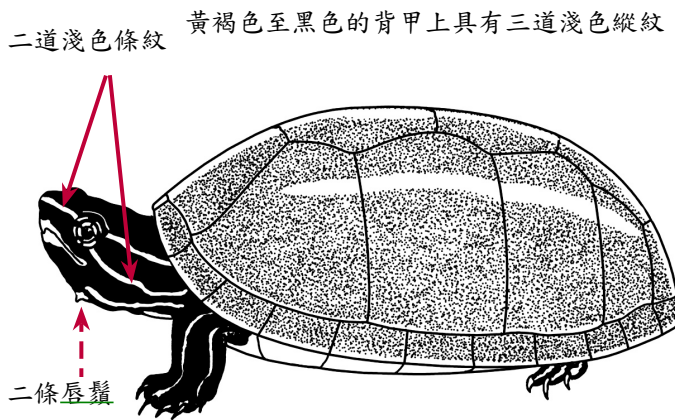

👤 Kinosternon baurii

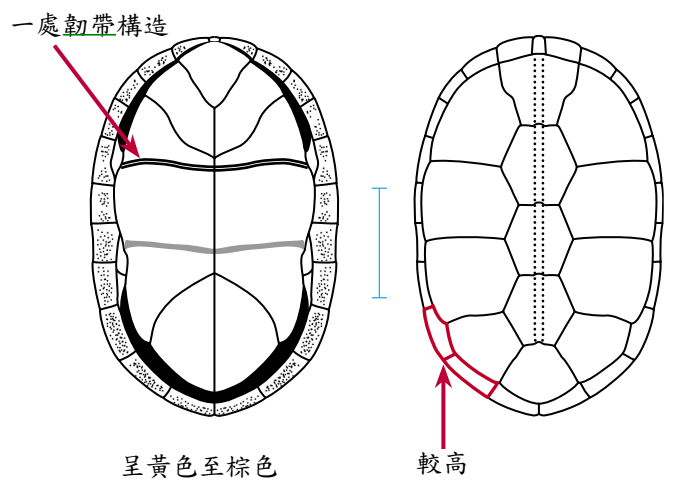
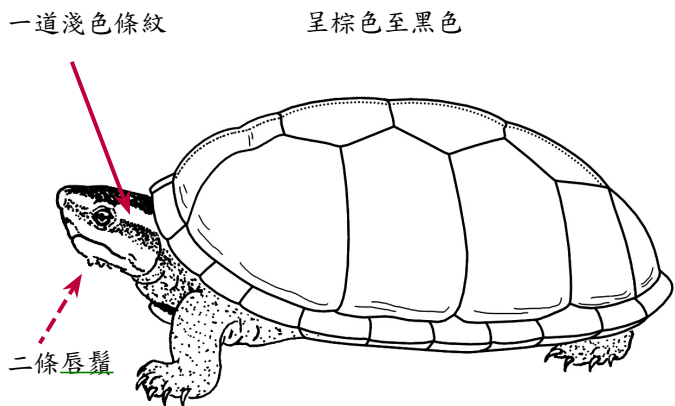

👤 Kinosternon leucostomum



呈棕色至黑色

二處韌帶構造

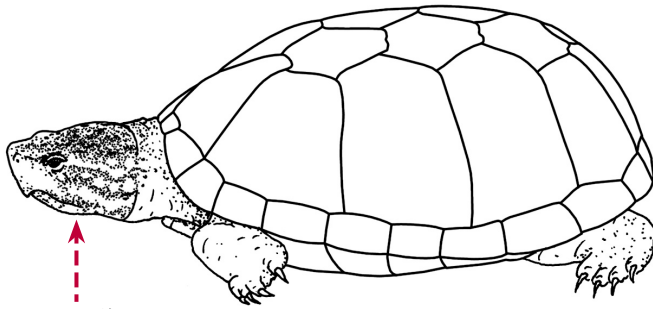

二條唇鬚

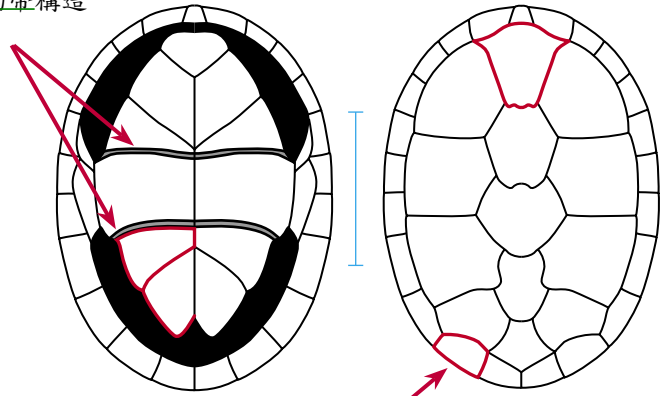

呈黃色

較高

幼體具有三道稜脊



Kinosternon subrubrum

黃色或白色

一處韌帶構造

呈黃色至棕色

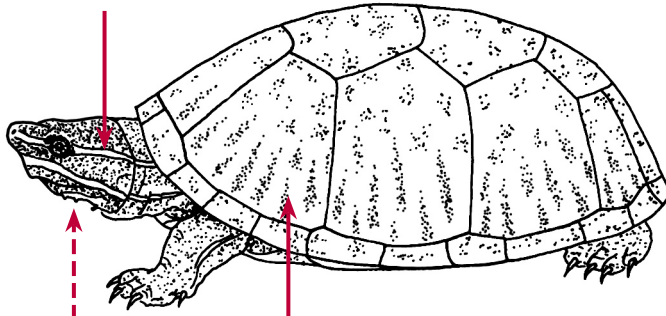

二至四條唇鬚

幼體呈棕色至黑色間有深色斑點

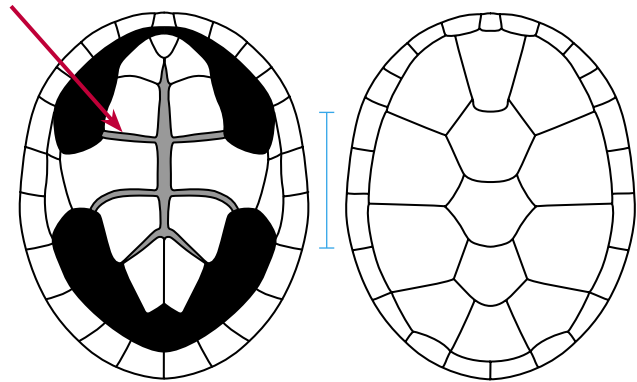

花紋隨個體變異

幼體具有一至三道稜脊



Sternotherus odoratus



黑色斑點

呈棕色至橘色並間有深色條紋

一處韌帶構造

幼體具有三道稜脊

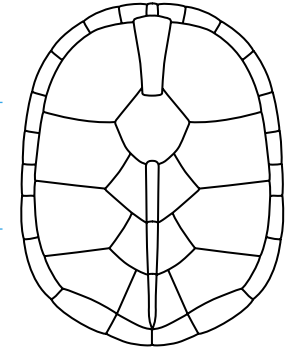
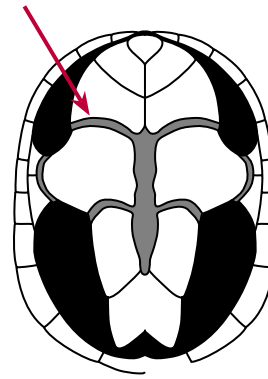
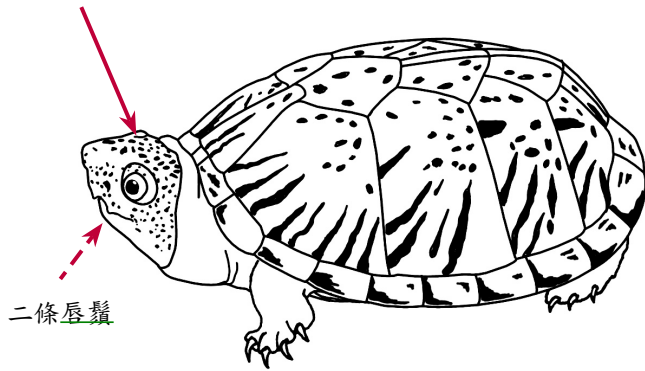

Sternotherus minor

呈棕色至橘色並間有深色條紋

一處韌帶構造

黃色

幼體具有三道稜脊

黑色條紋

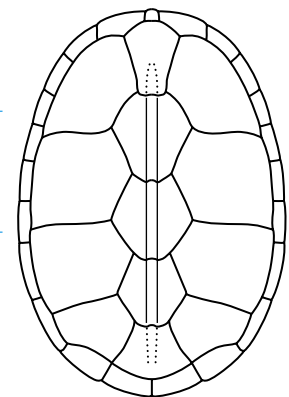
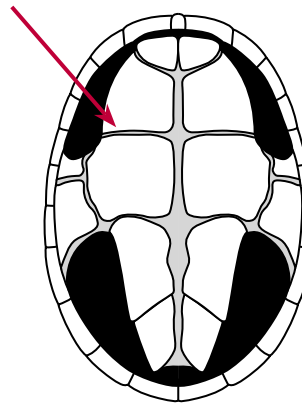
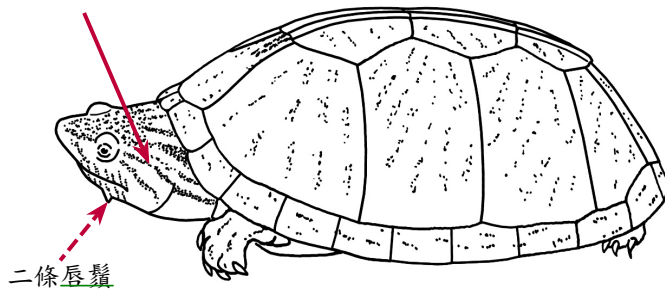

Sternotherus carinatus



黃色至紅色斑點

呈棕色至黑色

二處韌帶構造

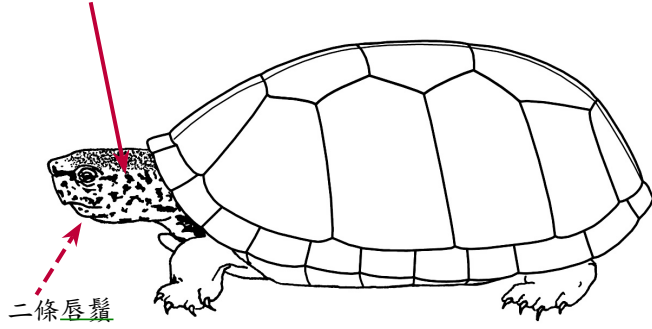

二條唇鬚

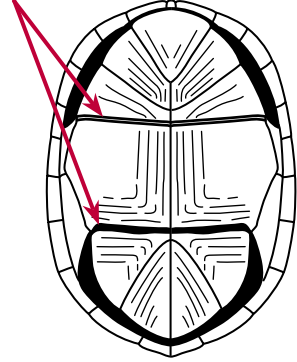

呈黃色至淡棕色

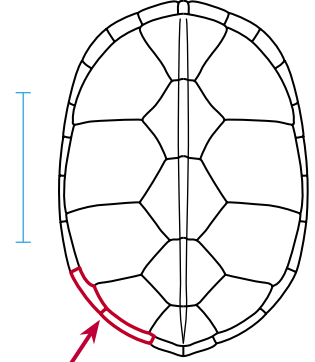

較高 幼體具有三道稜脊

 *Kinosternon acutum*

下列物種亦可發現
上述特徵

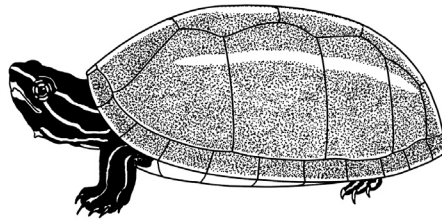

 *Kinosternon bairii* (juv.) 34

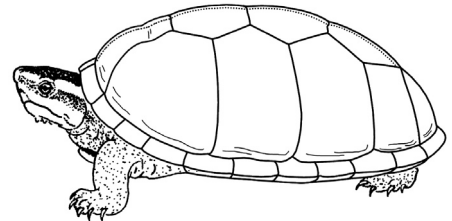

 *Kinosternon leucostomum* 34

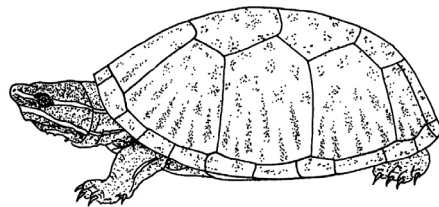

 *Sternotherus odoratus* (juv.) 35



棕色並具有深色斑點

呈棕色至黑色

一處韌帶構造

呈棕色

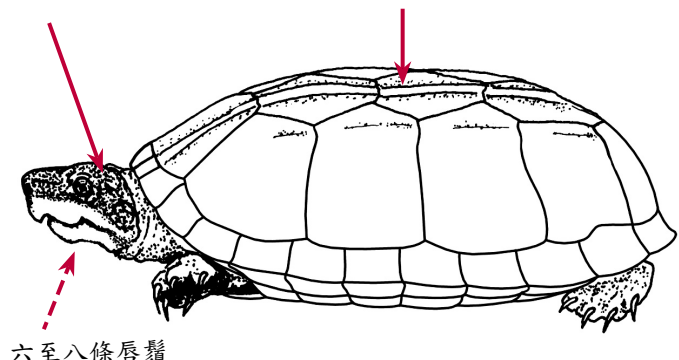

六至八條唇鬚

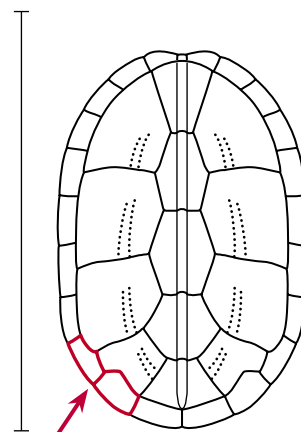
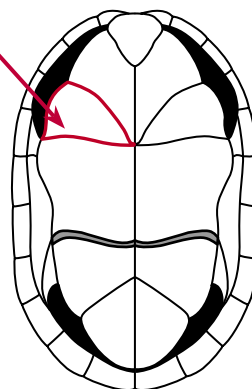

較高



Kinosternon scorpioides scorpioides



紅色或橘色斑點

呈黃色至橘色

一處韌帶構造

呈橘色

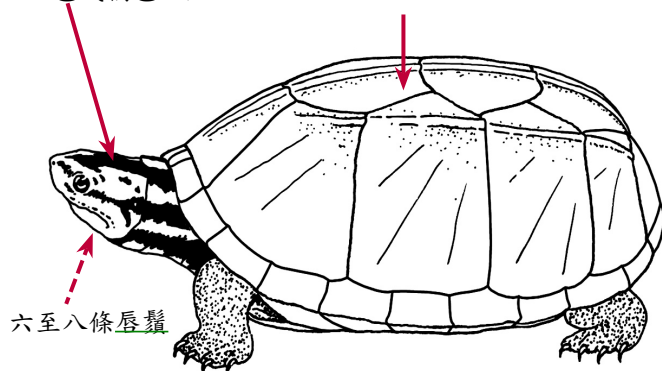

六至八條唇鬚

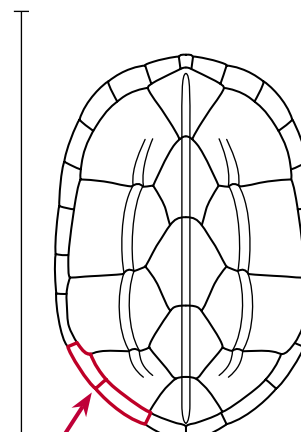
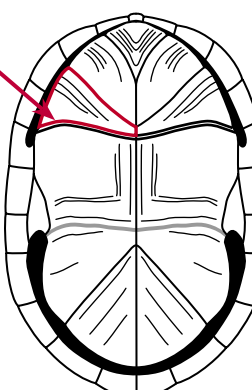

較高



Kinosternon scorpioides cruentatum



下列物種亦可發現上述特徵



Kinosternon acutum (juv.) 37



Kinosternon subrubrum (juv.) 35



Sternotherus odoratus (juv.) 35



Sternotherus minor (juv.) 36



Sternotherus carinatus (juv.) 36



Dermatemydidae 中美洲河龜科：👤 1 Sp. 👤 0 Sp.

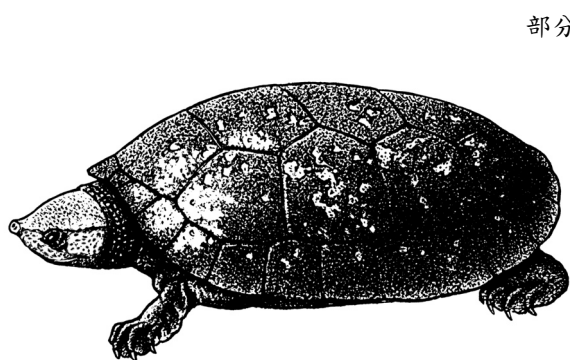

部分個體的喉盾分為二塊

三至六塊下緣盾

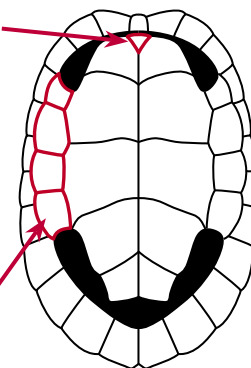

呈乳白色

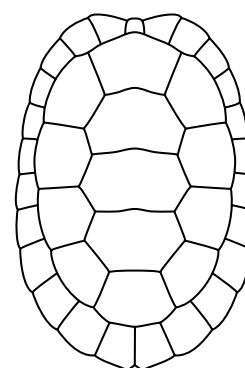

幼體具有脊



Dermatemys mawii



盾板隨著年齡增長會有癒合現象，長度會逐漸大於寬度



Emydidae 澤龜科：👤 12 Spp. I 或 II 👤 82 Spp.

呈棕色

呈黃色至橘色

具有韌帶構造

有時每塊盾板上具有深色斑點

椎盾數多於五塊

👤 *Notochelys platynota*

大型鱗片

呈棕色

韌帶構造

疣凸

1<2

👤 *Pyxidea mouhotii*

呈棕色

韌帶構造不明顯

1>2

👤 *Cycllemys dentata*



Emydidae 澤龜科：🚶 12 Spp. I 或 II 🚶 82 Spp.

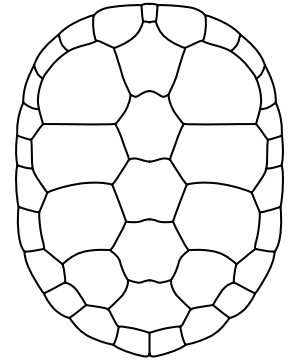
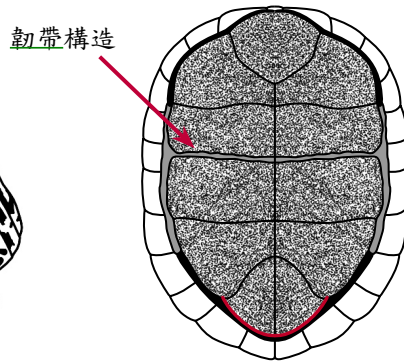
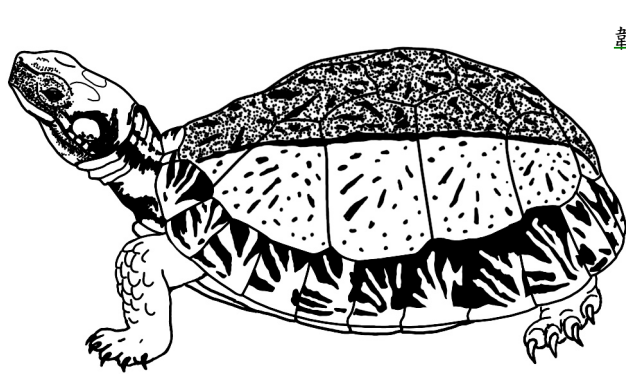

🚶 Cuora galbinifrons

呈棕色至黑色

幼體具有稜脊

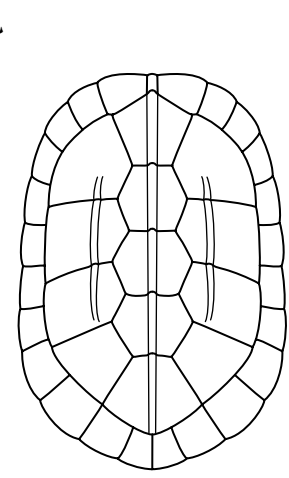
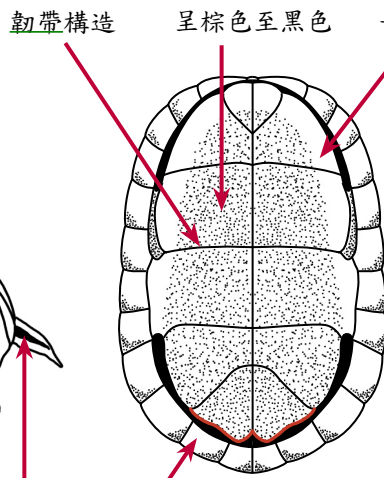
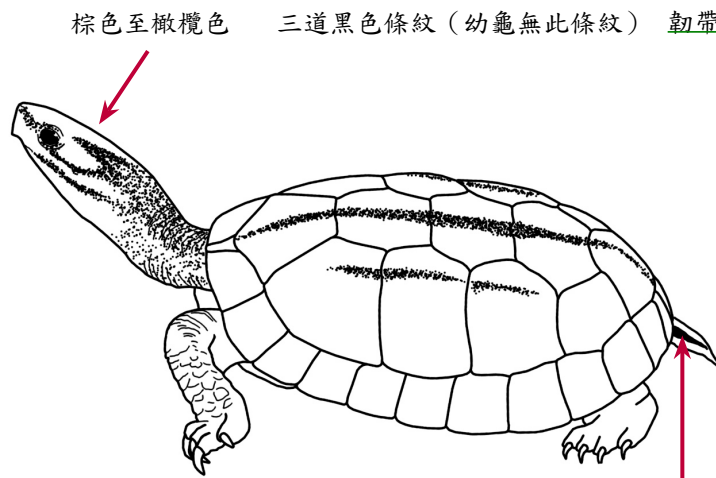

🚶 Cuora trifasciata

棕色至橄欖色

三道黑色條紋（幼龜無此條紋）

韌帶構造

呈棕色至黑色

黃色

二道黑色條紋

黃色至橘色

三道稜脊並具有黑色條紋

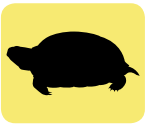

一道鑲有黑邊的黃色條紋

➡ 椎盾具有黃色條紋

呈黑色或黃色

韌帶構造

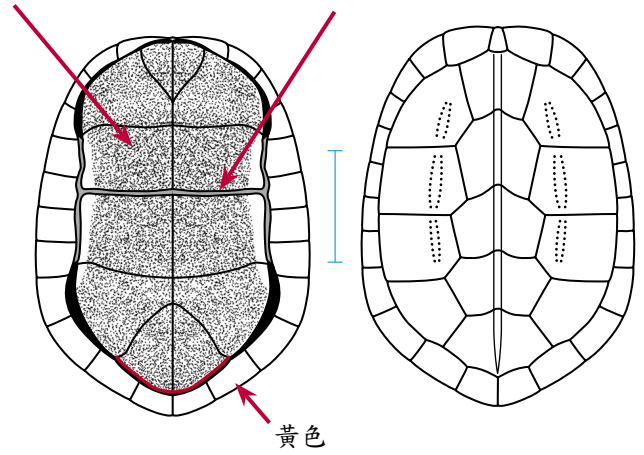
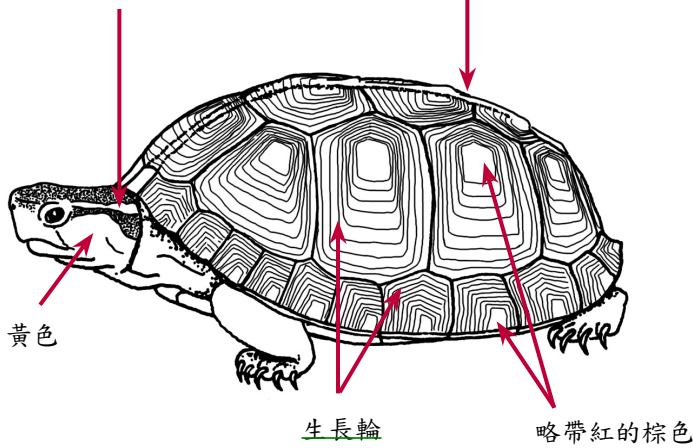

Cuora flavomarginata

三道黃色條紋

呈棕色或橄欖色

韌帶構造

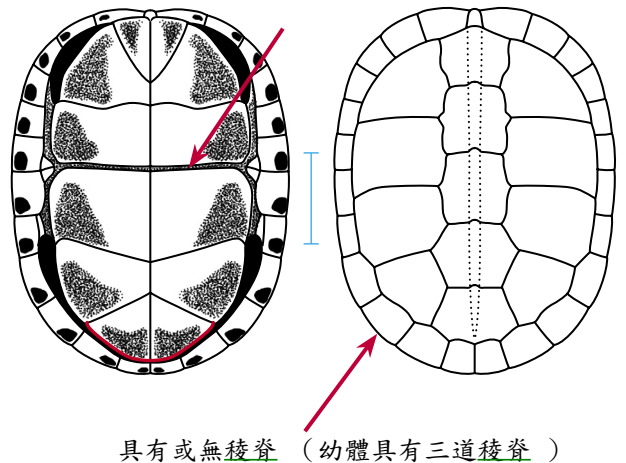
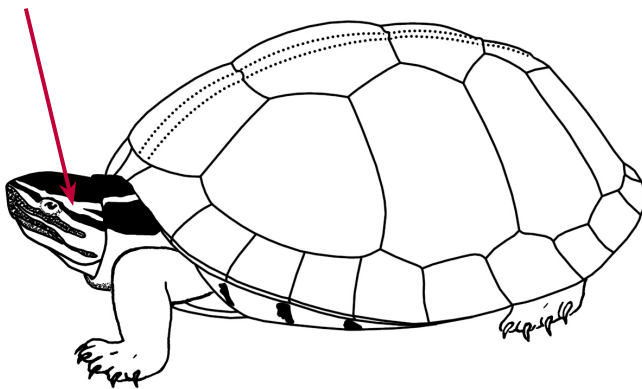

Cuora amboinensis

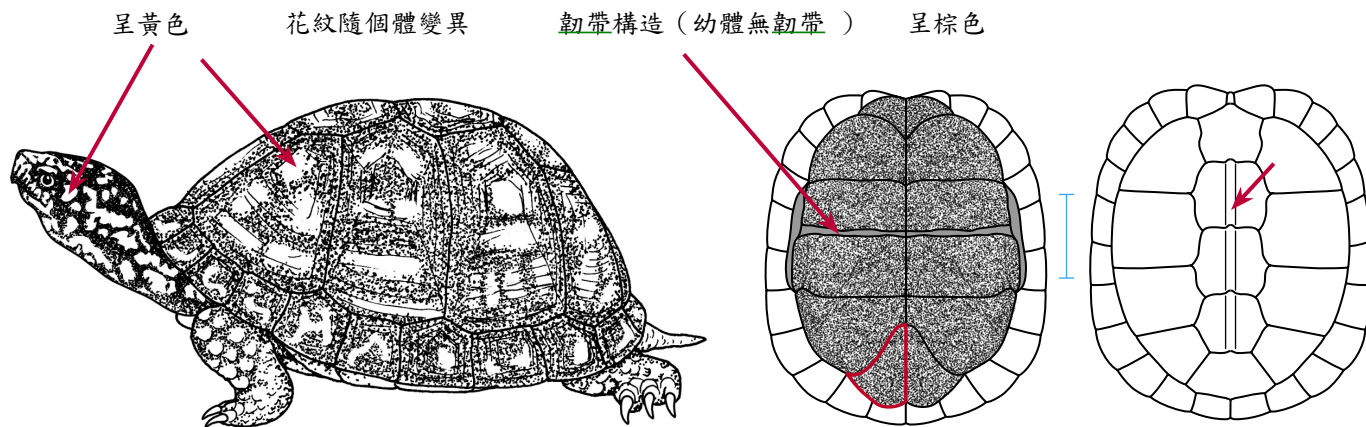

 Terrapene carolina

花紋隨個體變異

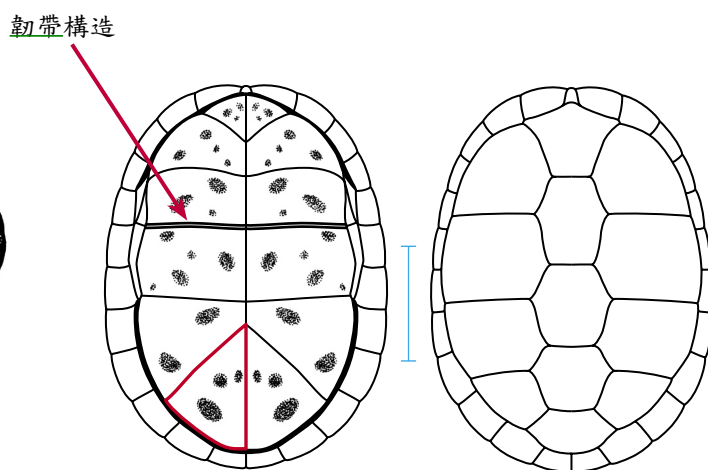
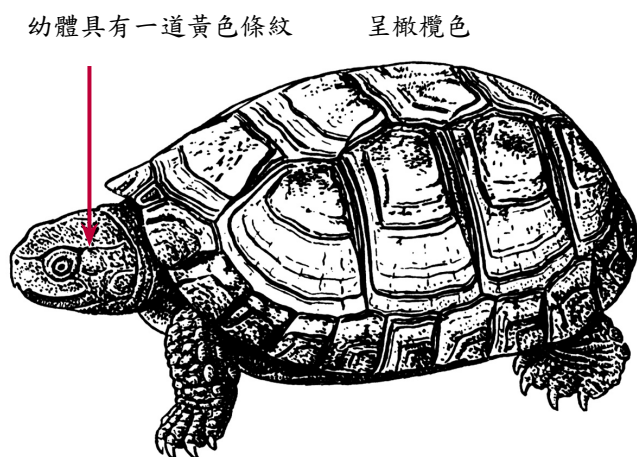

 Terrapene coahuila

黃色至橄欖灰色並間有深色斑點

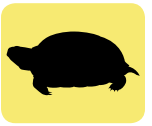

棕色或黃色斑點

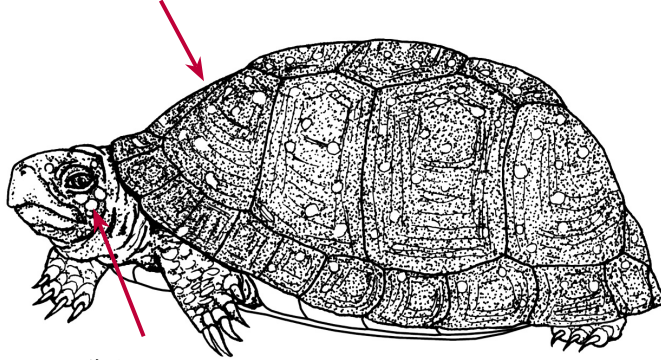

黃色斑點

韌帶構造

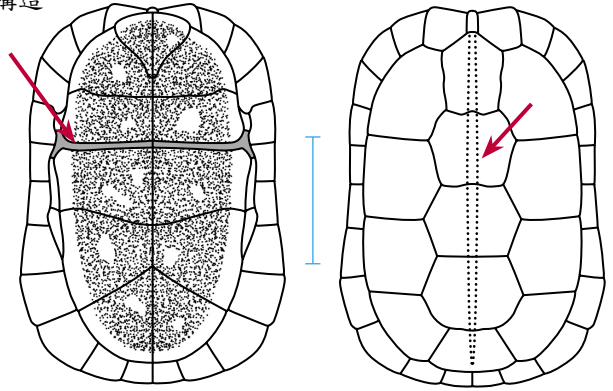

呈棕色，邊緣及斑點為黃色



Terrapene nelsoni

黃色

中央具有黃色條紋

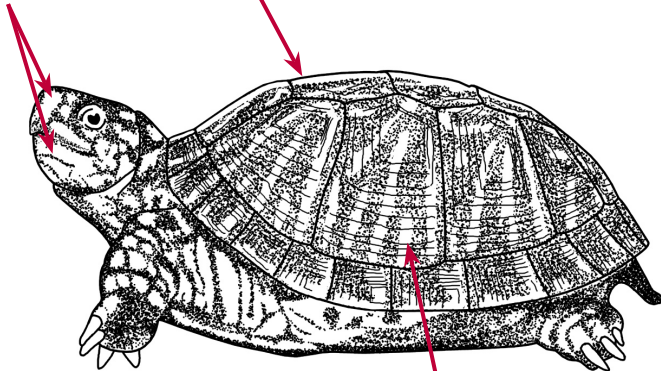

黃色

韌帶構造

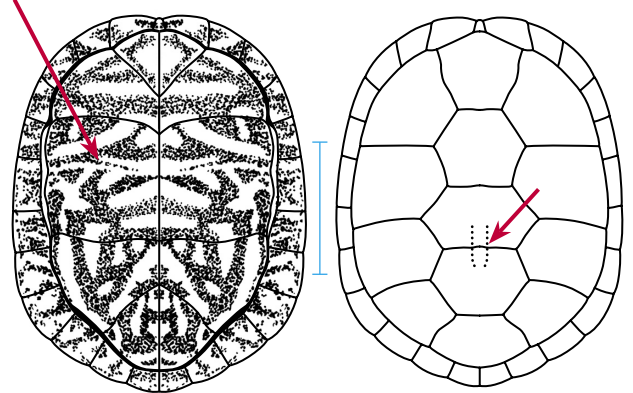

Terrapene ornata

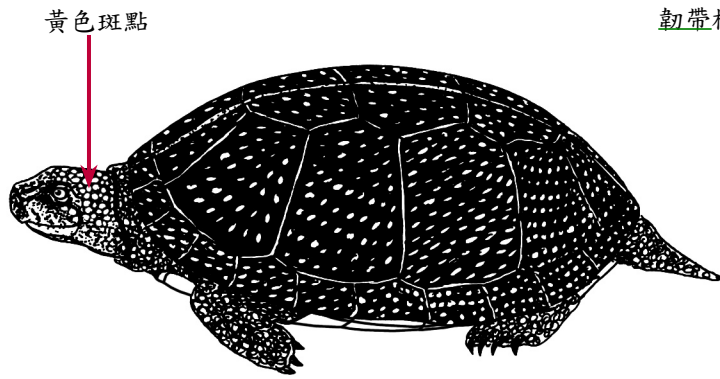

黃色斑點

幼體具有條紋

韌帶構造 花紋隨個體變異

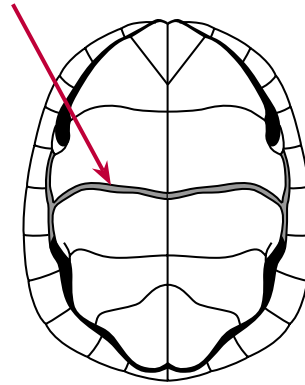

呈黃色至黑色

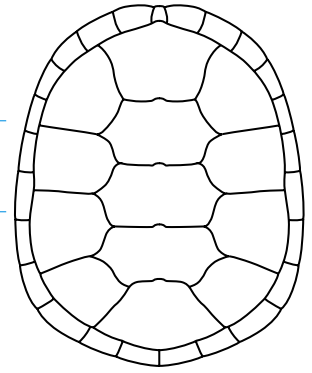

幼體具有稜脊



Emys orbicularis

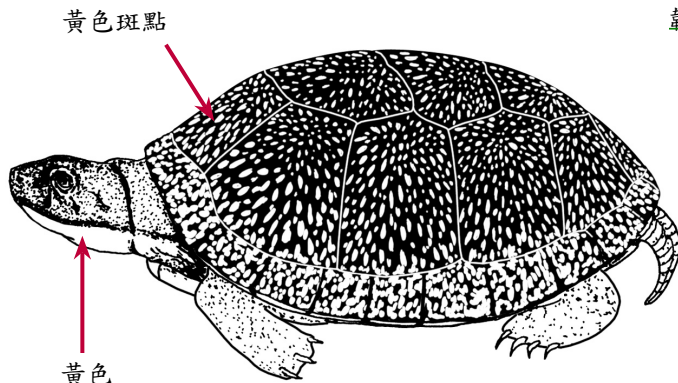

黃色斑點

黃色

韌帶構造

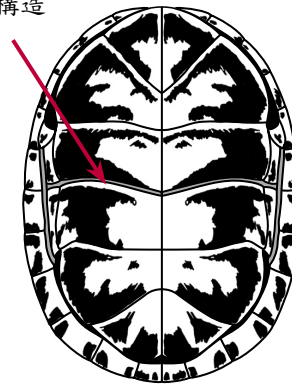

黃色具有變異的深色花紋

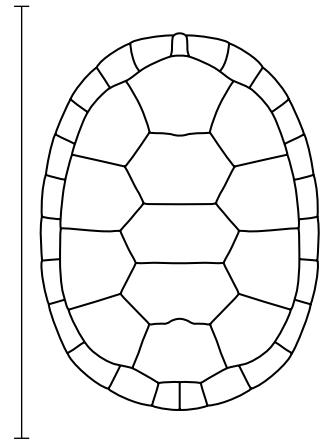

Emydoidea blandingii



Emydidae 澤龜科：12 Spp. I 或 II 82 Spp.

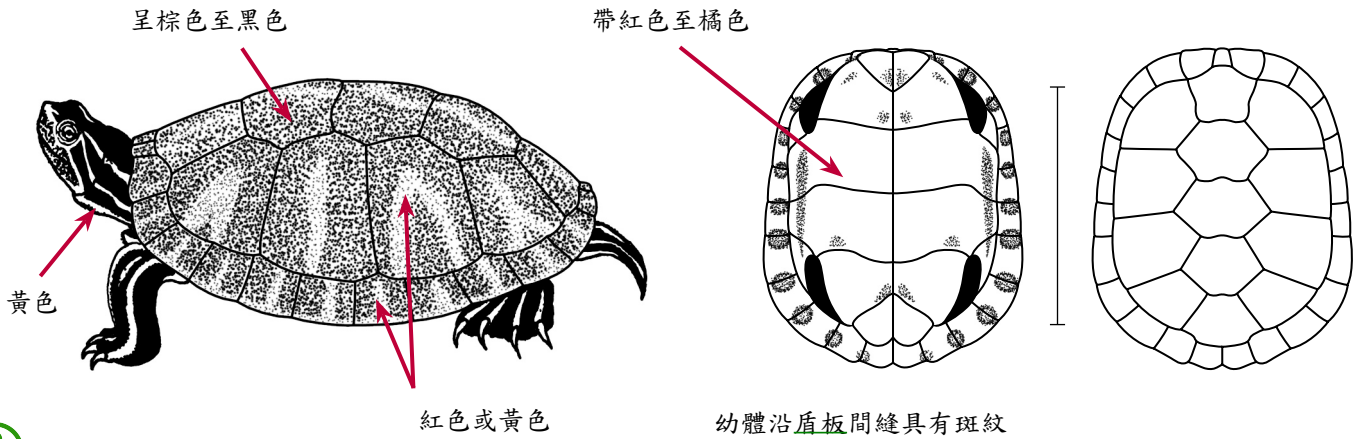

Pseudemys rubriventris

下列物種的背甲有時亦有鋸齒狀突起，無稜脊

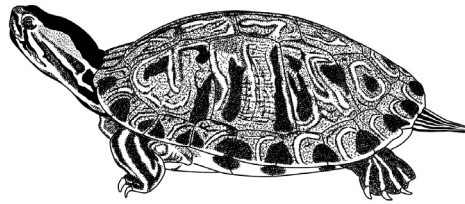

Trachemys scripta elegans 52

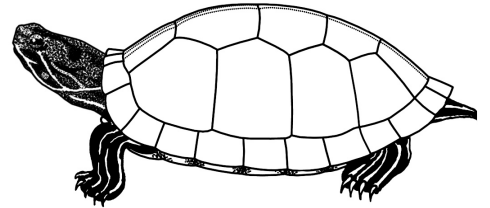

Trachemys stejnegeri 56

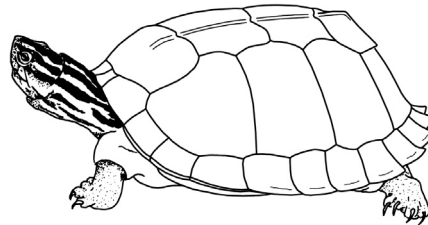

Cyclemys tcheponensis 54

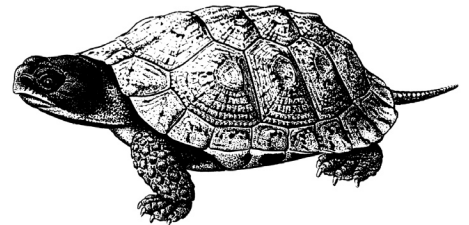

Clemmys insculpta (juv.) 54



Emydidae 澤龜科：🚶 12 Spp. I 或 II 🚶 82 Spp.

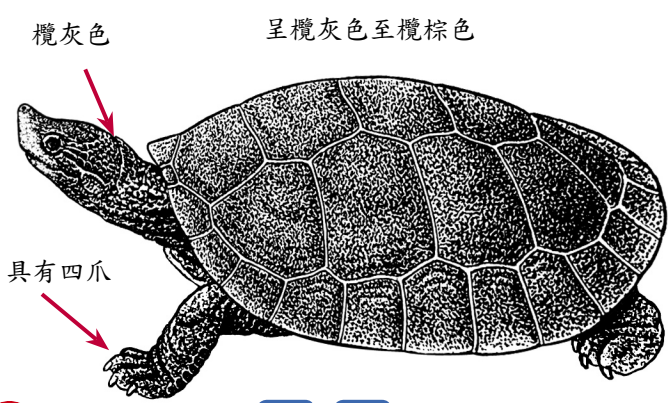

🚶 Batagur baska 🍴 🍷

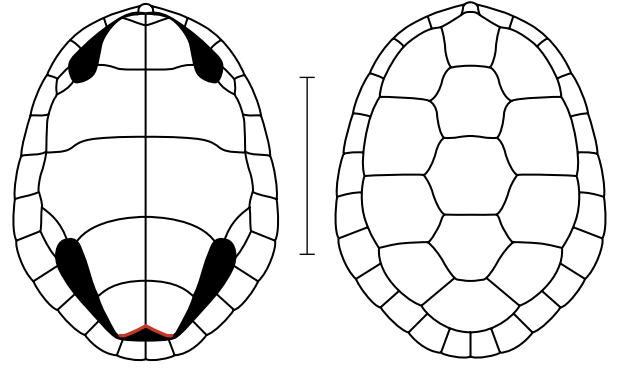

呈黃色或乳白色 幼體具有一道微凸的稜脊

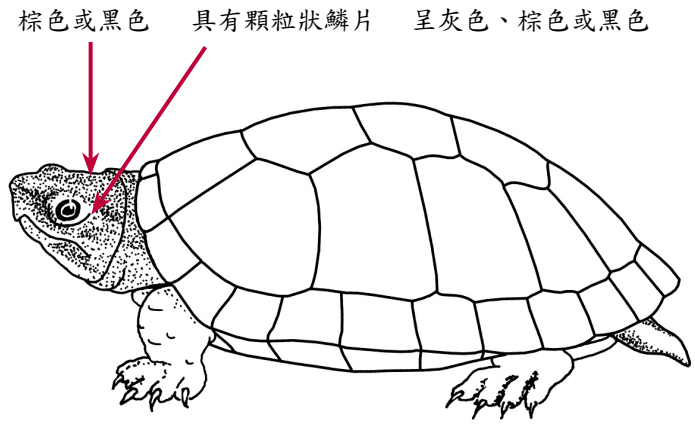

🚶 Orlitia borneensis

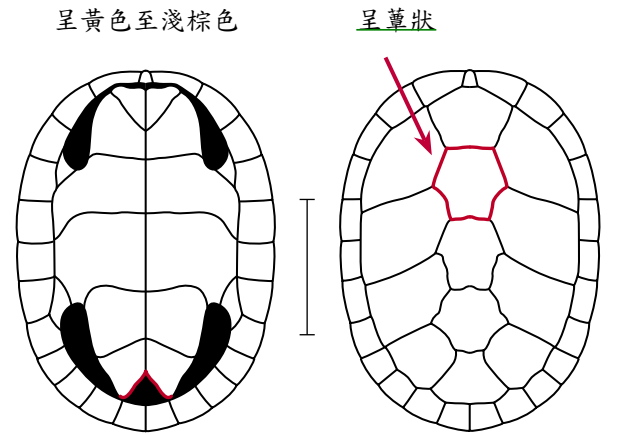

呈黃色至淺棕色 呈薑狀 幼體背甲具有微凸的稜脊及鋸齒狀構造

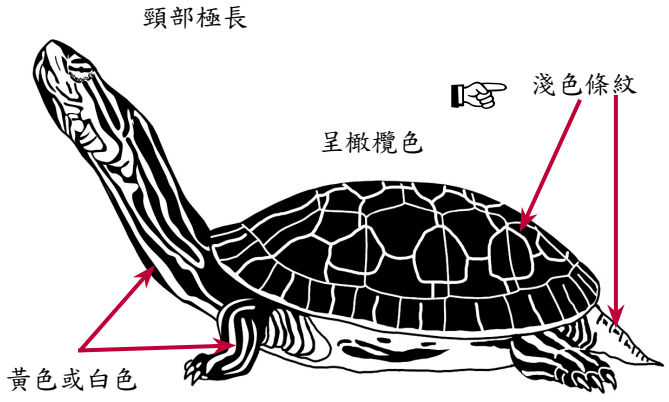

🚶 Deirochelys reticularia 🍴

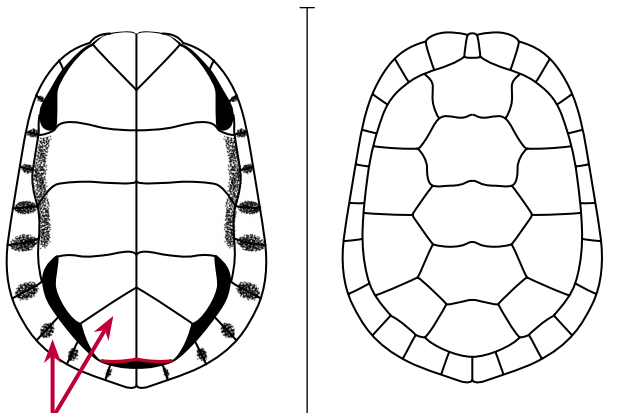

呈黃色 (花紋隨個體變異) 幼體背甲具有微凸的稜脊



呈橄欖色或灰色

棕色至橄欖色並具有三道黑色條紋

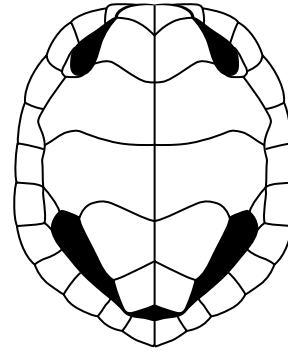
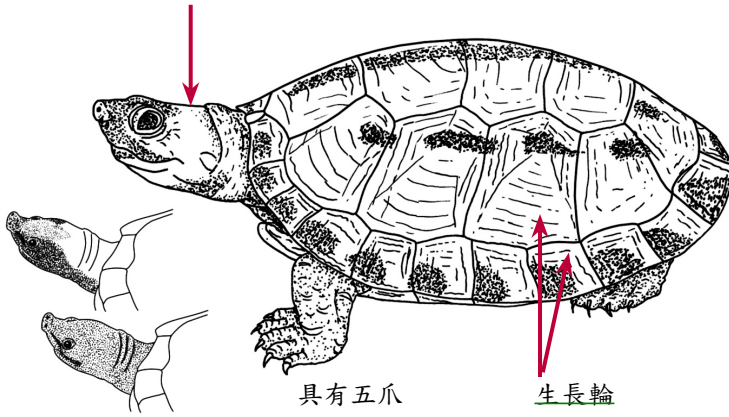

呈黃色或乳白色

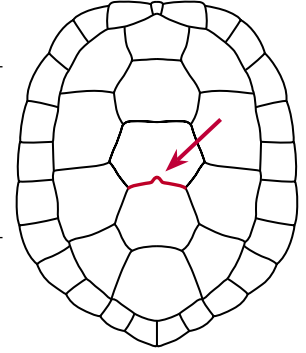

幼體具有三道稜脊



Callagur borneoensis



呈棕色至黑色

黃色或橘色污斑

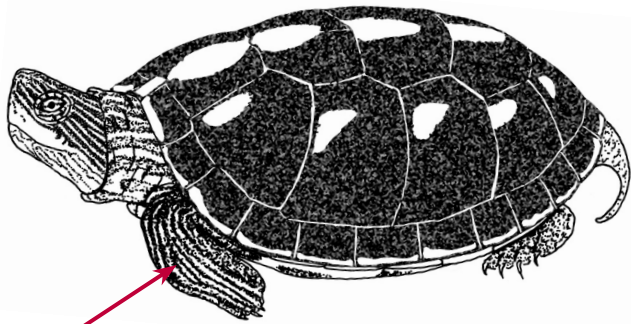

綠色至黃色條紋

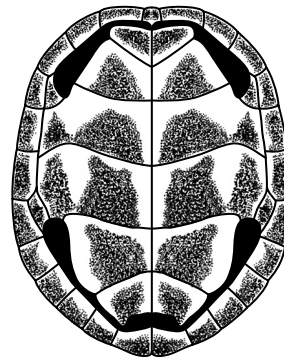

呈黃色並間有黑色污斑

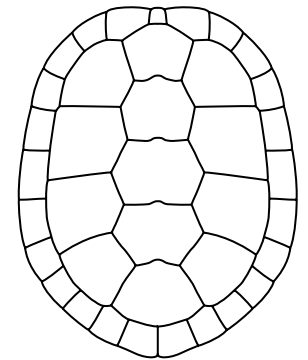

幼體具有三道微凸稜脊



Ocadia sinensis



深色條紋及斑點

呈橄欖色至黑色

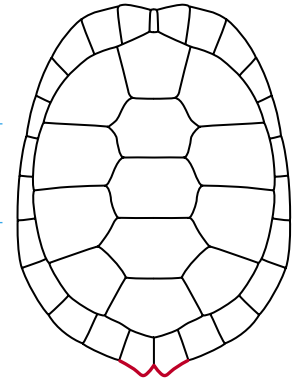
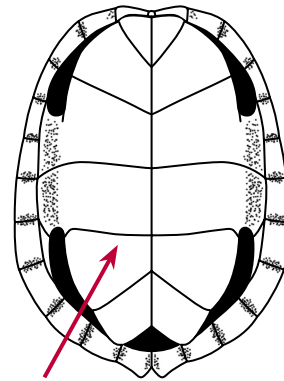
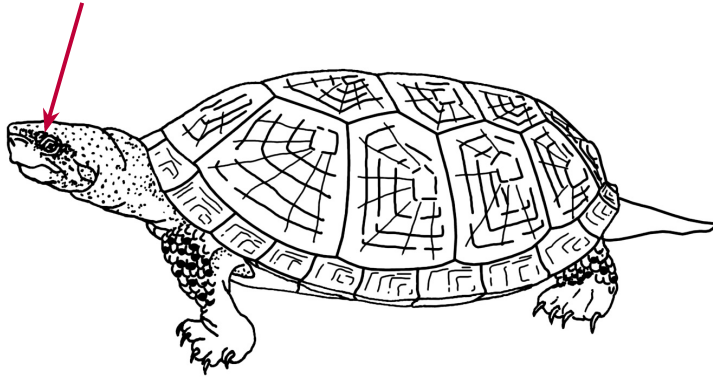

呈黃色（有時具有污斑）

幼體具有稜脊



Clemmys marmorata

背甲呈黑色並間有黃色斑點

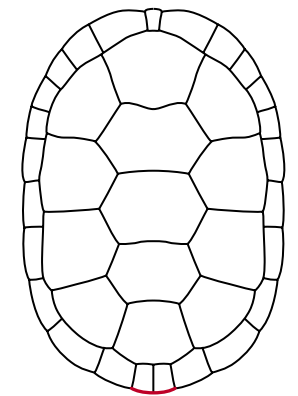
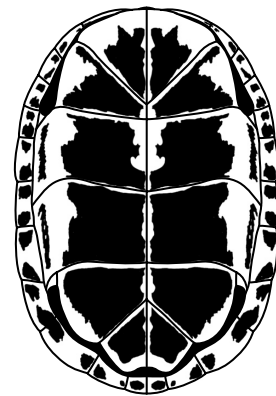
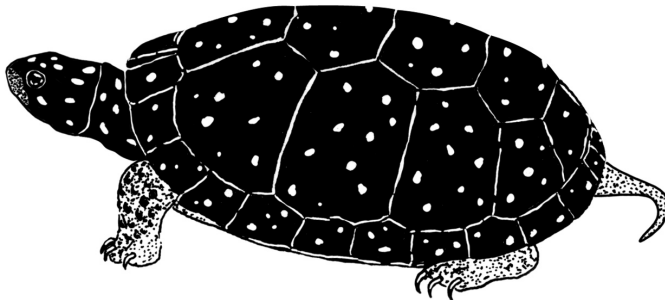

呈黃色並間有黑色污斑



Clemmys guttata

黃色、橘色或紅色

呈棕色至黑色

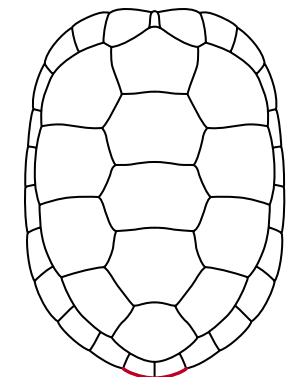
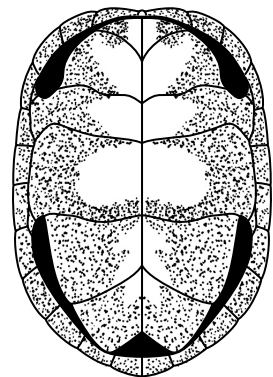
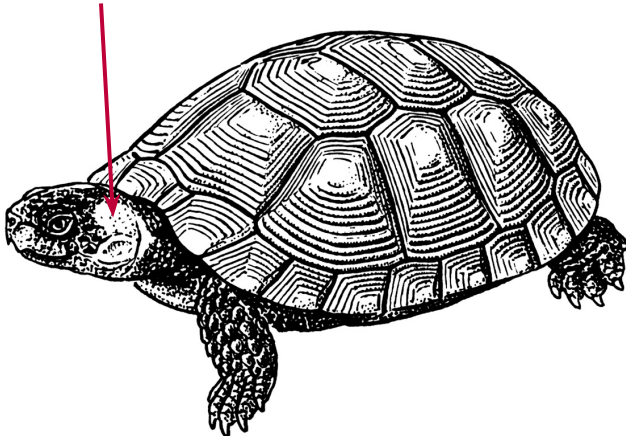

呈棕色至黑色並間有淡色污斑

有時具有微凸的稜脊



Clemmys muhlenbergii

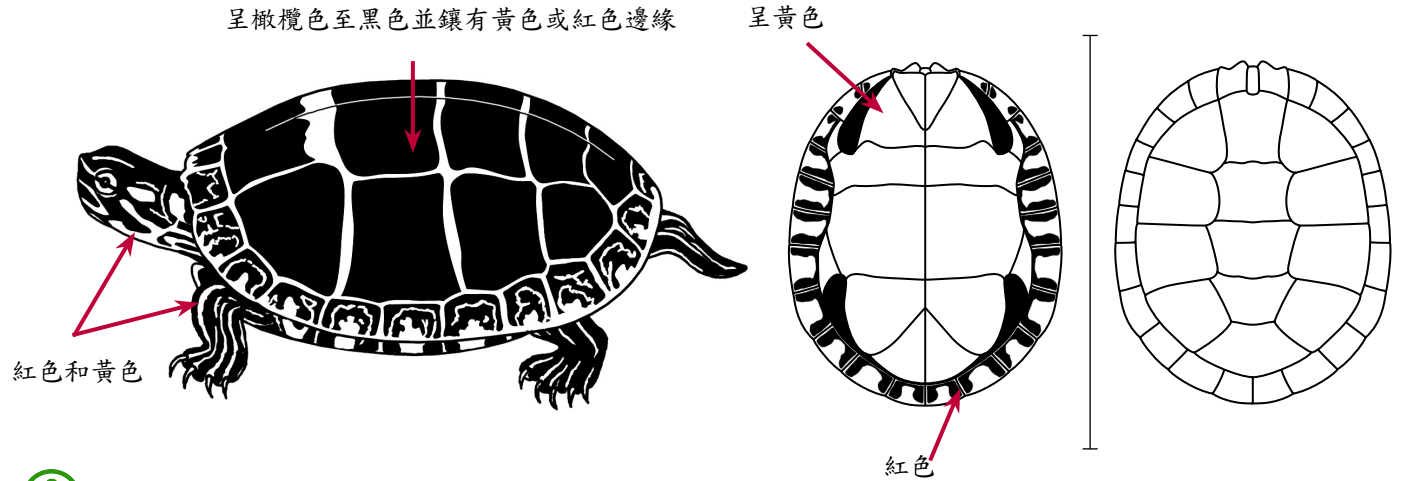

Chrysemys picta picta

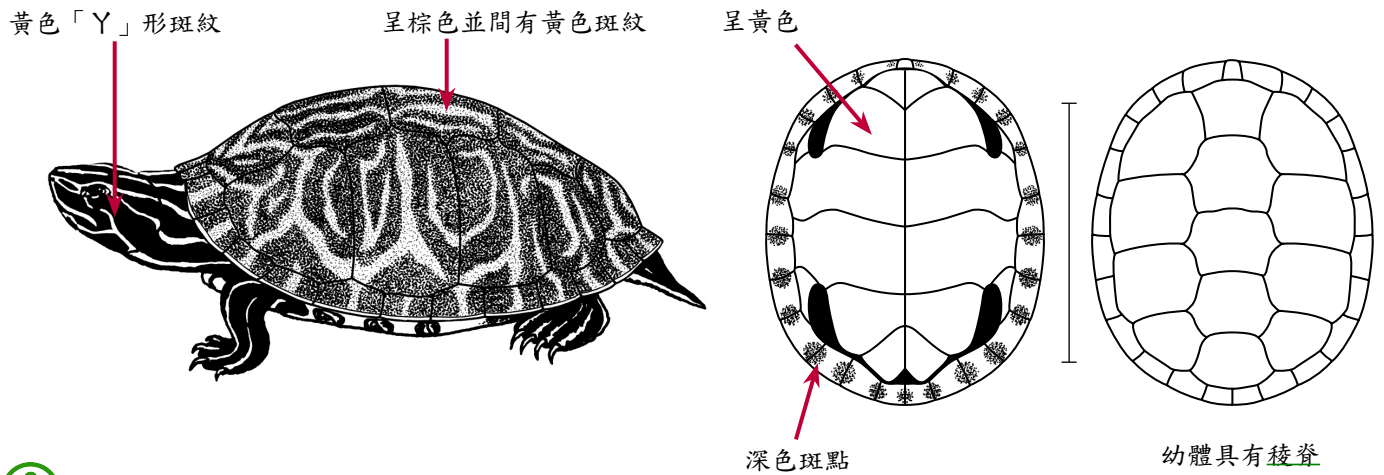

Pseudemys floridana

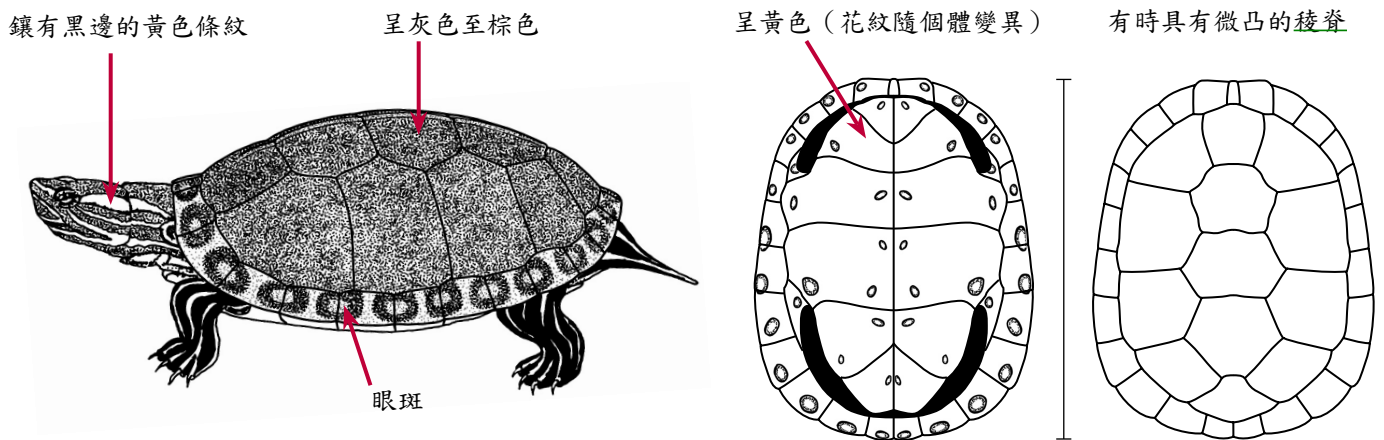

Trachemys decorata

Trachemys stejnegeri 亦有上述特徵 56



Emydidae 澤龜科：🚶 12 Spp. I 或 II 🚶 82 Spp.

呈棕色至橄欖色

呈黃色至乳白色

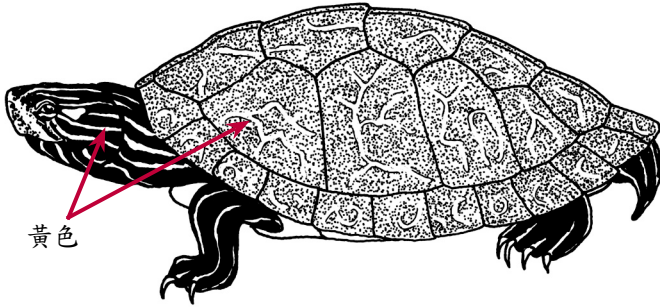

黃色

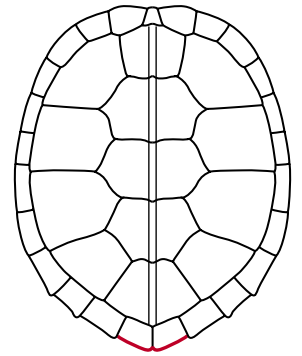
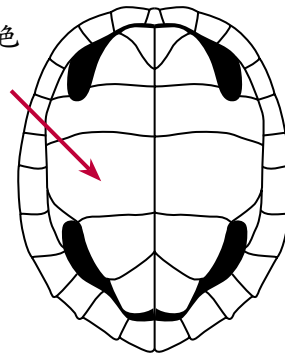

幼體的盾板間縫具有深色線條花紋



Graptemys geographica

呈深橄欖綠色

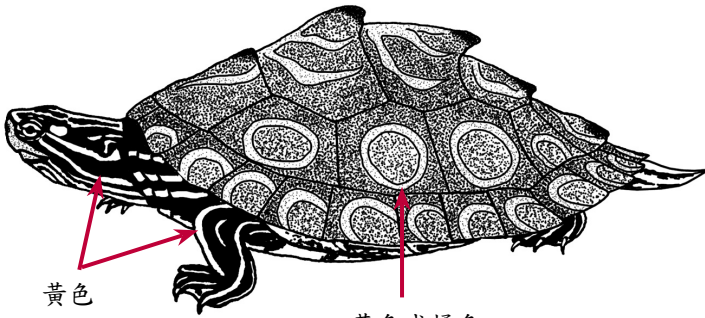

黃色

黃色或橘色

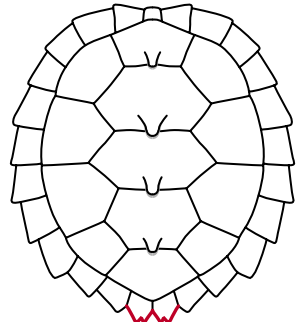
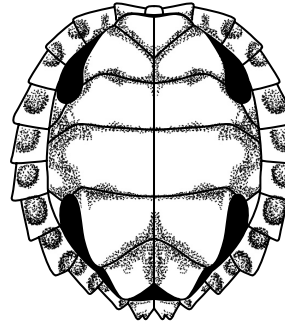

呈黃色或橘色並有橄欖棕色花紋

稜脊上有節狀突起



Graptemys oculifera

G.p. kohnii



呈棕色至橄欖色並間有黃色斑紋及深色污斑

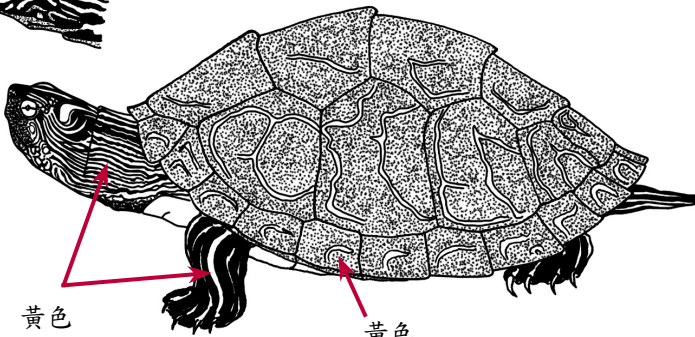

黃色

黃色

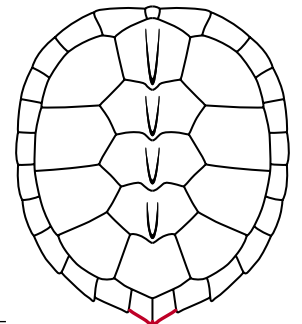
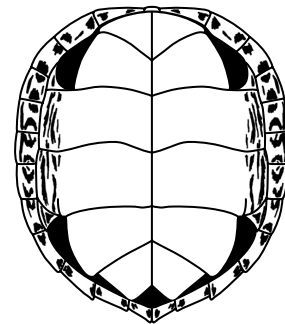

呈黃色至乳白色（幼體具有深色線條）

稜脊上有節狀突起



Graptemys pseudogeographica pseudogeographica



橄欖色並有黃色條紋

呈橄欖色至棕色並有花紋變異的黃色斑紋

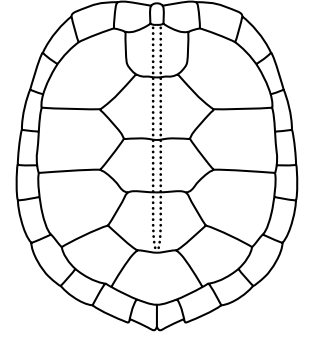
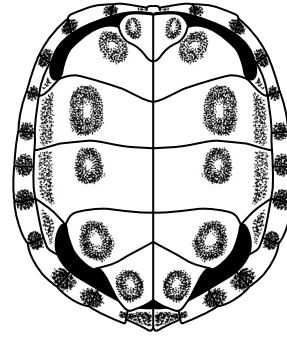
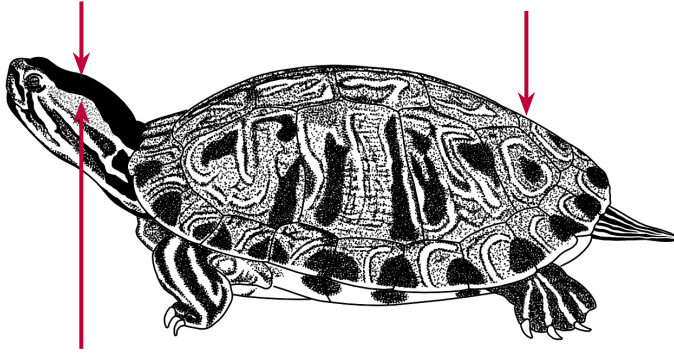

紅色、橘色或黃色

呈黃色（花紋隨個體變異）



Trachemys scripta elegans

灰色至橄欖色

呈棕色、橄欖色或灰色（幼體呈黃色）

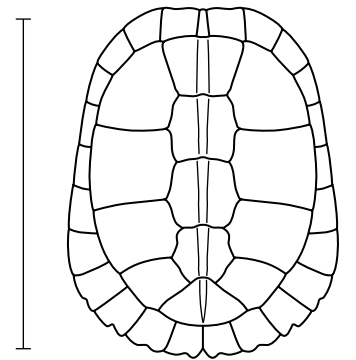
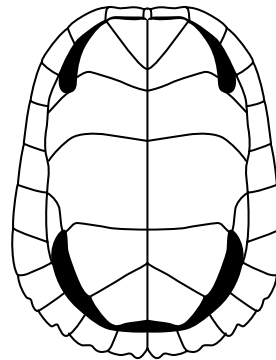
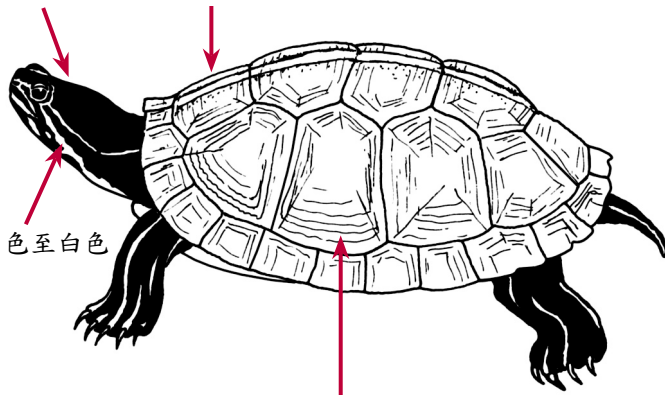

乳白色至白色

成排皺褶

呈乳白色至黃色



Trachemys terrapen

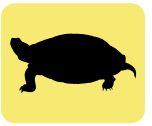

綠色至棕色，有黃色、橘色或粉紅色污斑

呈棕色至黑色，中央稜脊部份有一道淺白色條紋

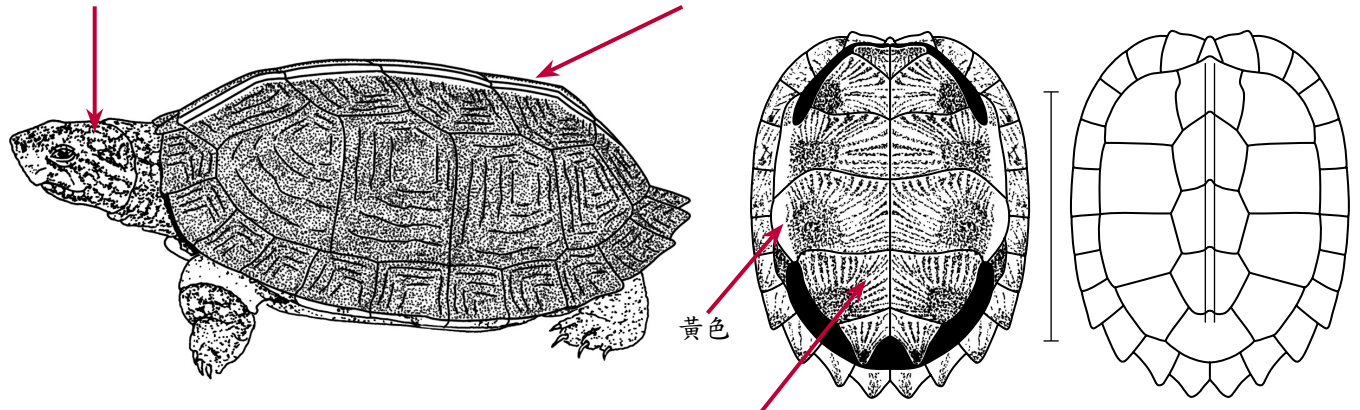

呈黃色並具有深色花紋（顏色隨年齡增長而變淡）

 Heosemys grandis

灰色至棕色並有黃色污斑

呈棕色，中央稜脊部位有一道淺色條紋

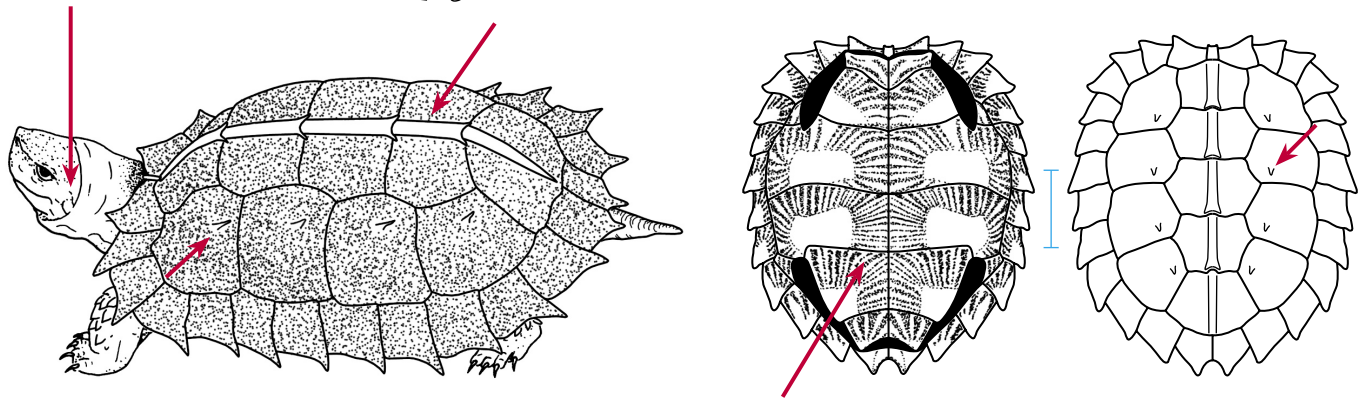

呈黃色並具有深色線條

 Heosemys spinosa



四道黃色、橘色或粉紅色條紋 呈棕色至橄欖色

呈黃色至棕色

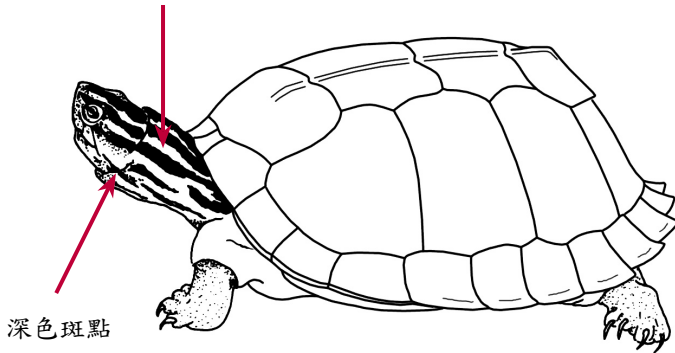

深色斑點

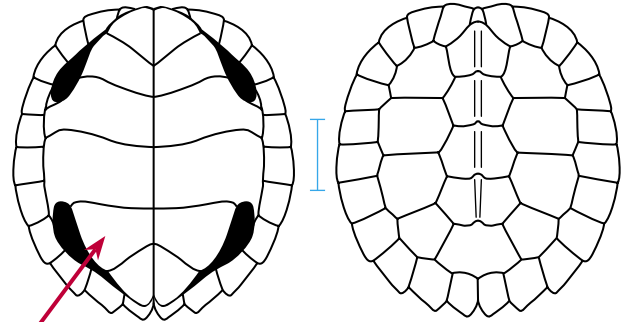

幼體呈粉紅色或紅色並有輻射狀深色花紋

幼體具有稜脊



Cyclemys tcheponensis

略帶黑色 呈灰色至棕色間有黑色或黃色條紋 尾部極長

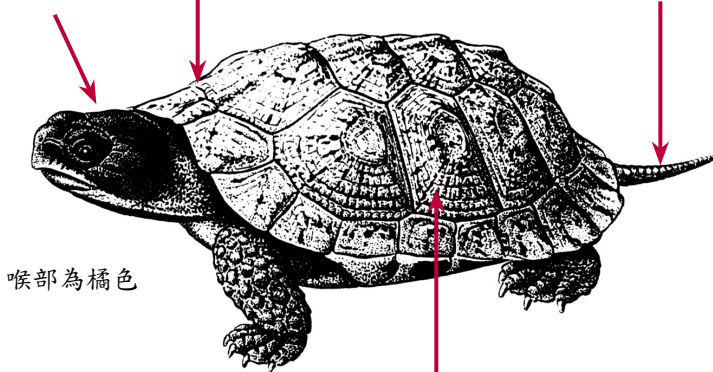

喉部為橘色

生長輪

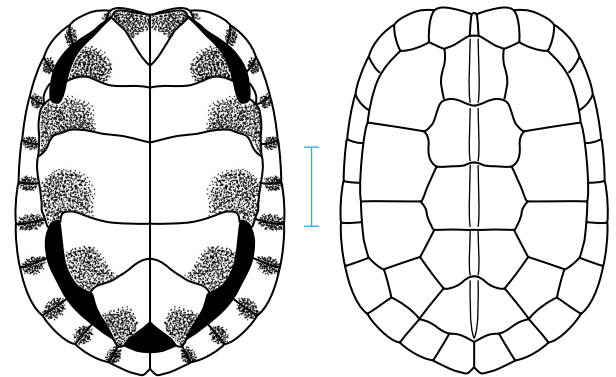

呈黃色並有黑色污斑

幼體不具稜脊



Clemmys insculpta

黑色至灰色間有白色或黃色斑點

棕色至黑色

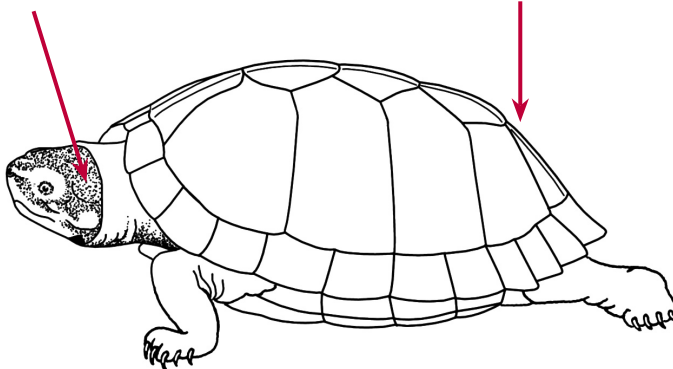

Siebenrockiella crassicollis

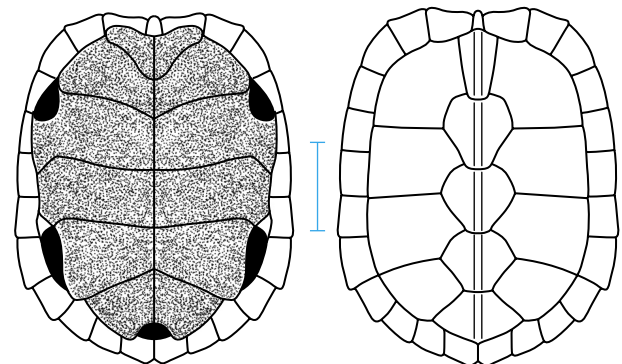



有些個體具有花紋

幼體具有三道稜脊

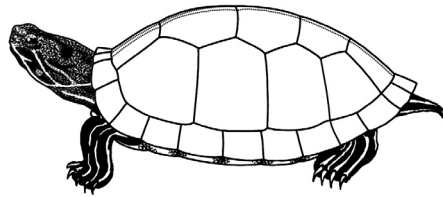

下列種類亦有上述之特徵



 *Trachemys stejnegeri* 56

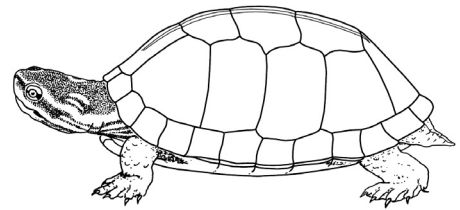

 *Hieremys annandalei* 56

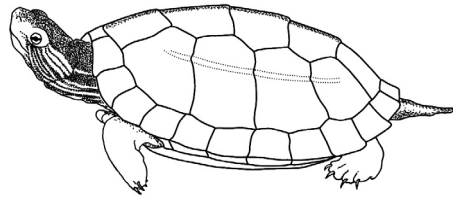

 *Chinemys nigricans* 60

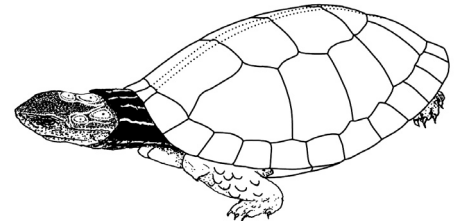

 *Sacalia quadriocellata* 57

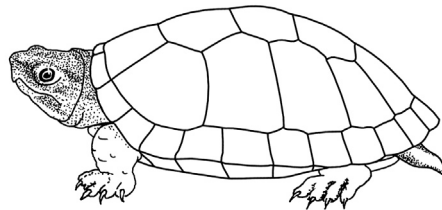

 *Orlitia borneensis* (juv.) 47

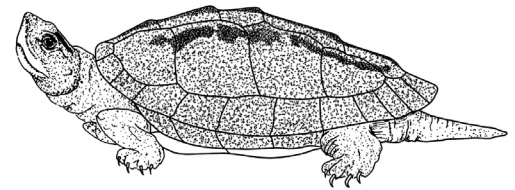

 *Kachuga trivittata* (juv.) 57

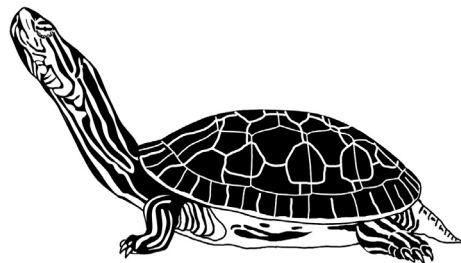

 *Deirochelys reticularia* (juv.) 47



Emydidae 澤龜科：🚶 12 Spp. I 或 II 🚶 82 Spp.

棕色至橄欖色並具有乳白色至黃色條紋 呈灰色、棕色、橄欖色或黑色 (幼體具有黃色條紋)

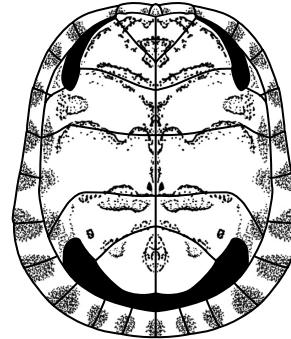
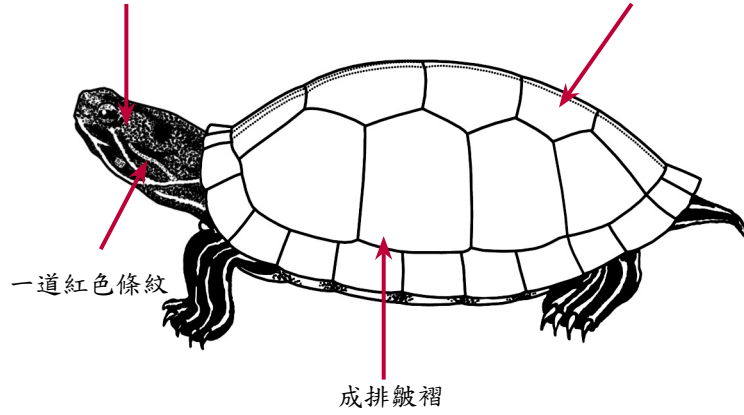

呈黃色具有或無花紋

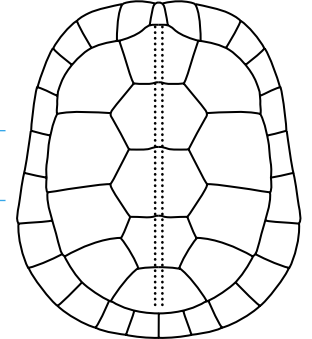

有些個體邊緣鋸齒狀突起較為明顯

🚶 Trachemys stejnegeri

呈橄欖色並有灰色花紋 (幼體具有黃色條紋) 棕色至黑色

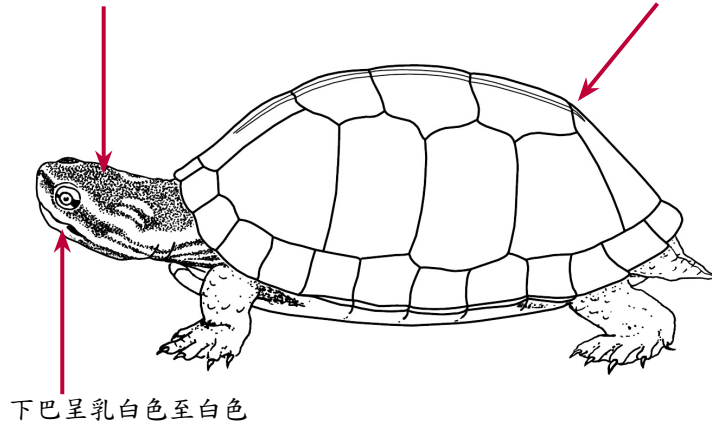

呈黃色並具有黑色污斑

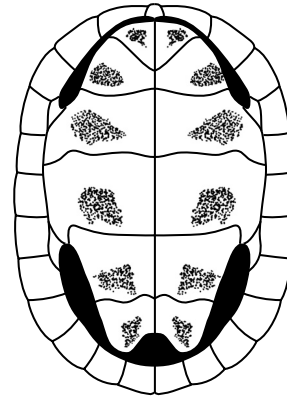

幼體呈黃色

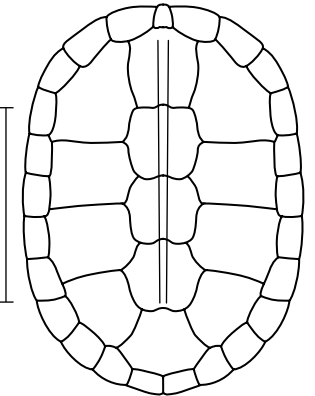

有些個體邊緣鋸齒狀突起較為明顯

🚶 Hieremys annandalii



黑色並具有橘色至黃色污斑

呈棕色有時有黃色或橘色鑲邊，中央並有紅色或橘色條紋

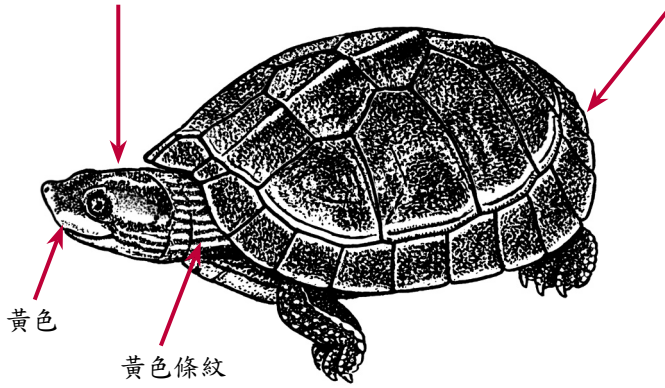

黃色

黃色條紋

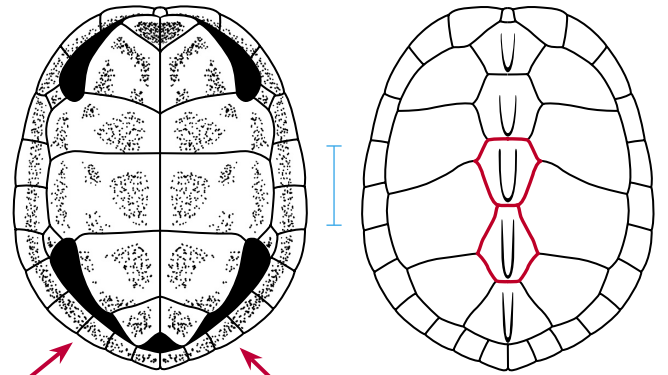

呈黃色於每塊盾板上具有黑色污斑



Kachuga tecta



K. tentoria 於每塊盾板上僅有一塊黑色污斑

棕色至橄欖色並有黑色條紋

雄龜呈棕色至橄欖色並有三道黑色條紋

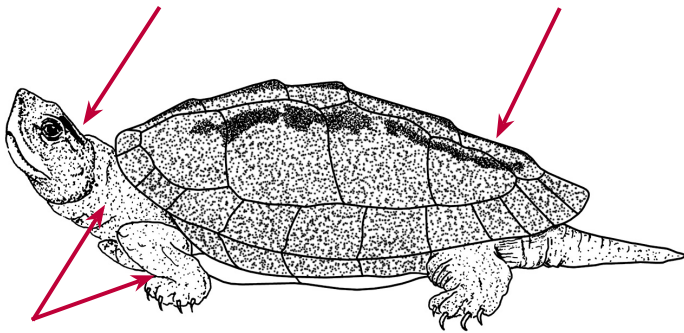

略帶黃的棕色

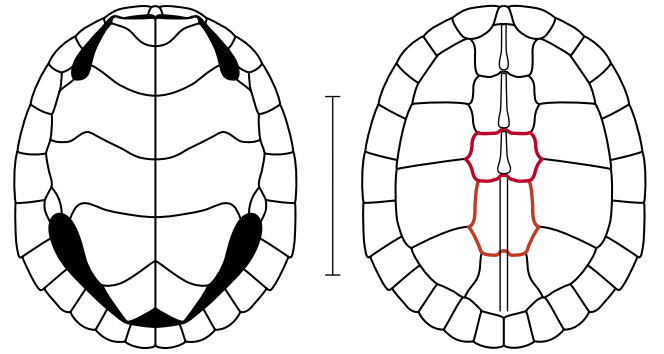

呈黃色至橘色

幼體具有鋸齒狀突起



Kachuga trivittata

呈棕色具有或無斑紋

略帶黃色至橄欖色，具有或無花紋

棕色或橄欖色並有四塊眼斑

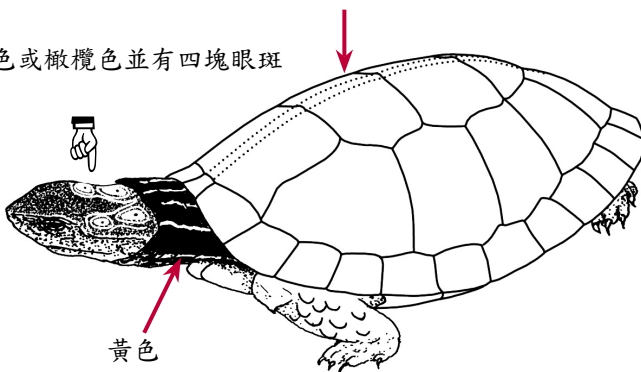

黃色

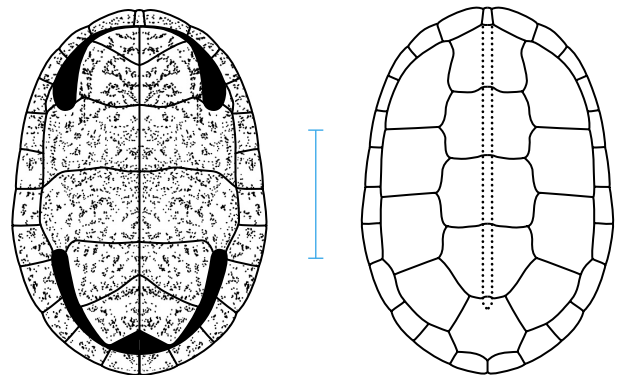

幼體具有鋸齒狀突起



Sacalia quadriocellata



Sacalia bealei 頭部僅具有二塊眼斑



橄欖色至棕色並具有二道黃色條紋

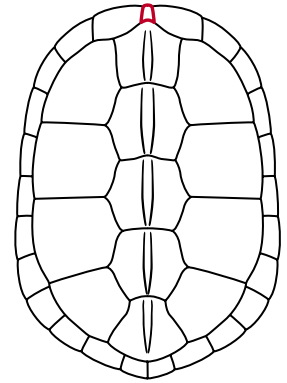
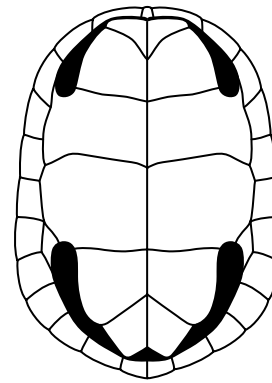
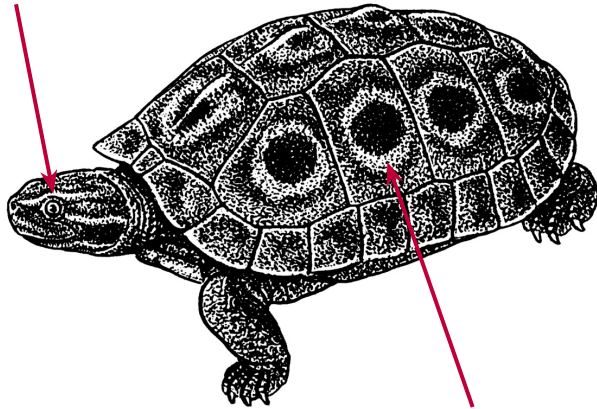

呈黃色

呈橄欖色、棕色或黑色，具有眼斑

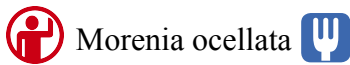

Morenia ocellata

呈橄欖色、棕色或黑色，中央有淺色條紋 每塊緣盾上有鮮明條紋

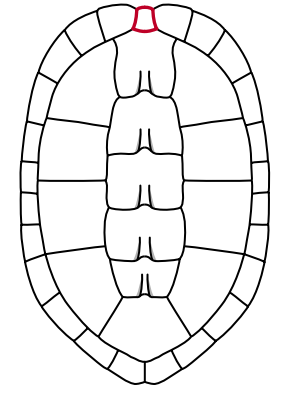
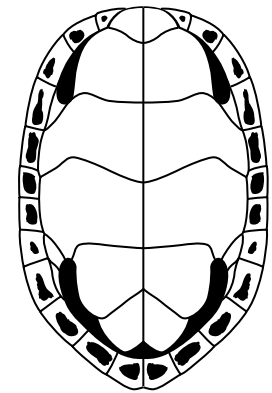
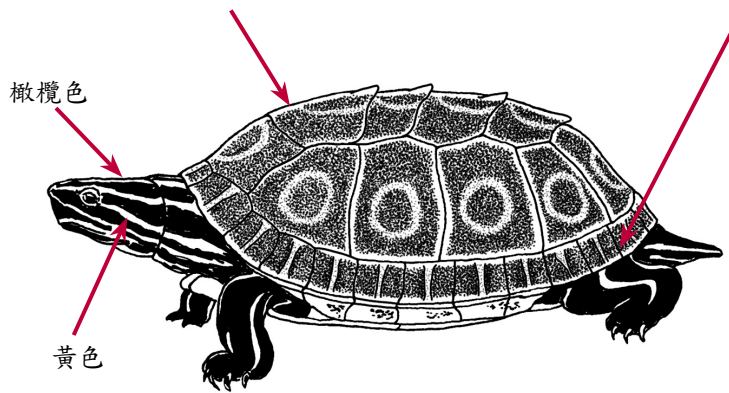

呈黃色

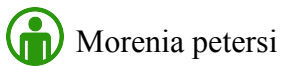

Morenia petersi

灰色至黑色並具有斑紋

呈灰色、棕色或黑色

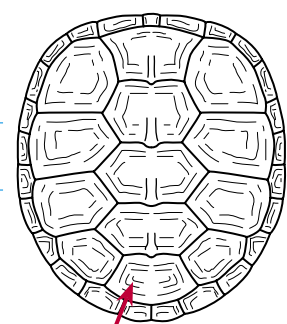
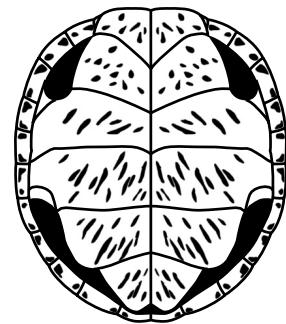
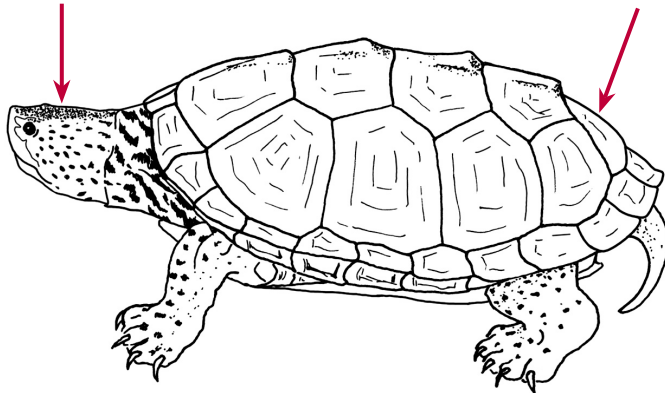

呈綠色至黃色並有深色污斑

生長輪

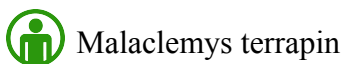

Malaclemys terrapin



下列種類的背甲亦可能出現有一道稜脊，但邊緣無鋸齒狀突起

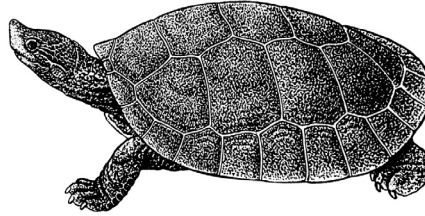

 *Batagur baska* (juv.) 47

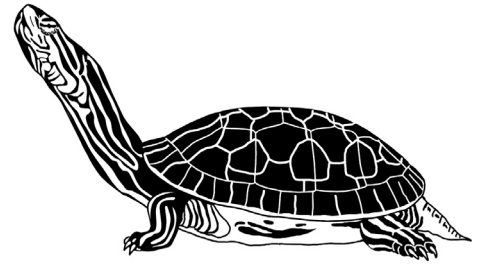

 *Deirochelys reticularia* (juv.) 47

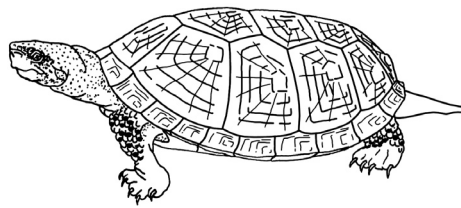

 *Clemmys marmorata* (juv.) 49

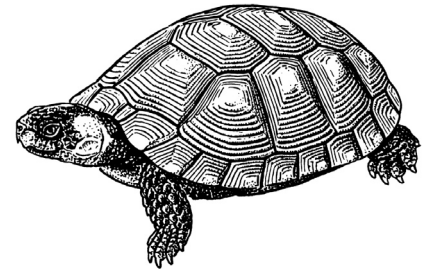

 *Clemmys muhlenbergii* (juv.) 49

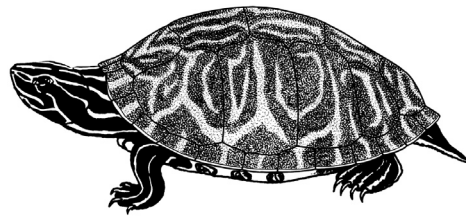

 *Pseudemys floridana* (juv.) 50

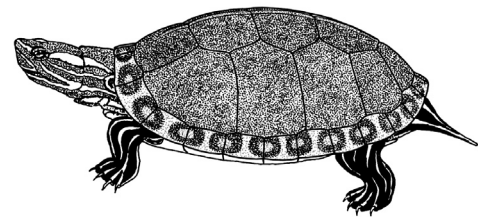

 *Trachemys decorata* 50

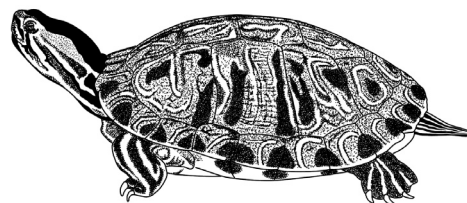

 *Trachemys scripta elegans* 52



Emydidae 澤龜科：🚶 12 Spp. I 或 II 🚶 82 Spp.

呈黑色並具有橘色、黃色、乳白色或白色斑紋

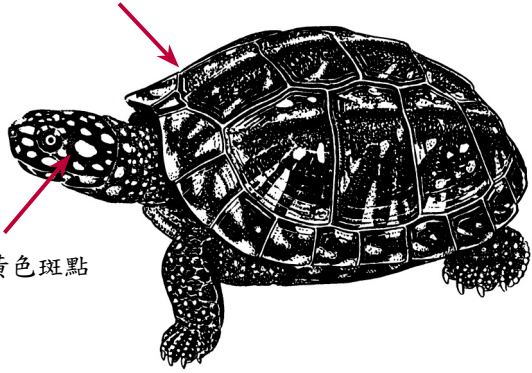

黑色並具有黃色斑點

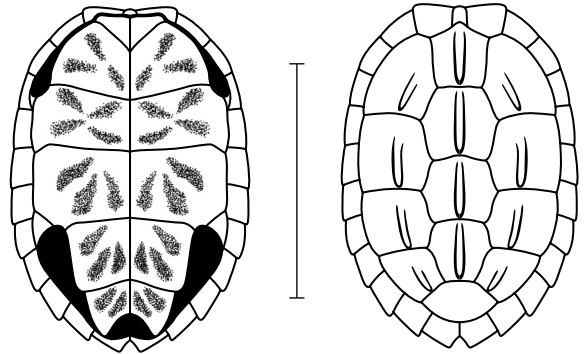

呈黃色並具有深色輻射狀花紋

🚶 *Geoclemys hamiltonii*

灰色至橄欖色並具有黃色條紋 呈棕色、盾板間縫為深色

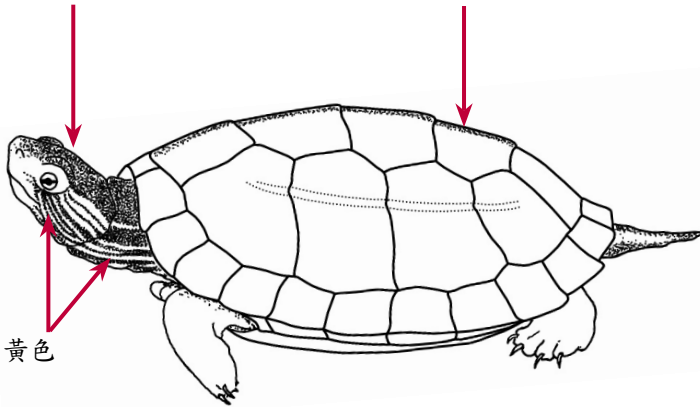

黃色

肋盾上稜脊隨年齡增長而消失

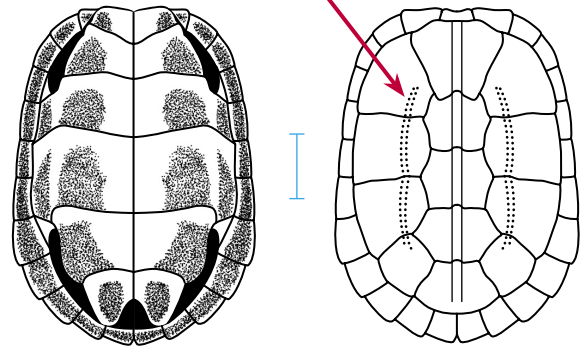

呈黃色至橘色並有黑色污斑

🚶 *Chinemys nigricans*

橄欖色至棕色並具有一道黃色條紋 稜脊旁顏色較深呈棕色

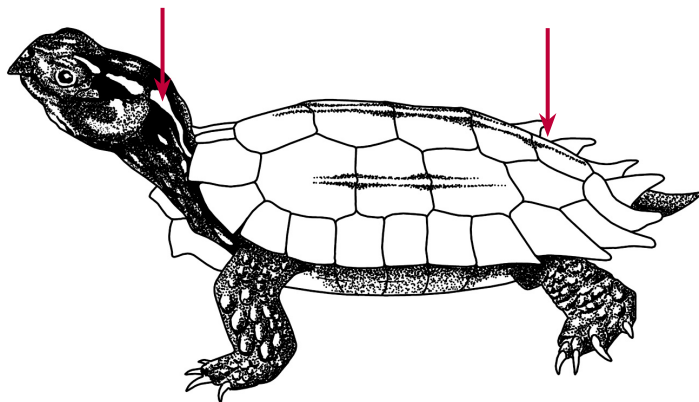

👉 呈棕色或黑色並鑲有黃邊

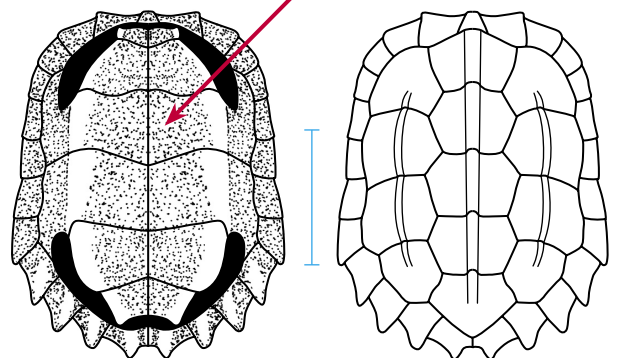

🚶 *Geoemyda spengleri*

Siebenrochiella crassicalis 亦有上述特徵 54



Emydidae 澤龜科：👤 12 Spp. I 或 II 🧑 82 Spp.

棕色至黑色 略帶紅的棕色至黑色並具有黃色至棕色的稜脊

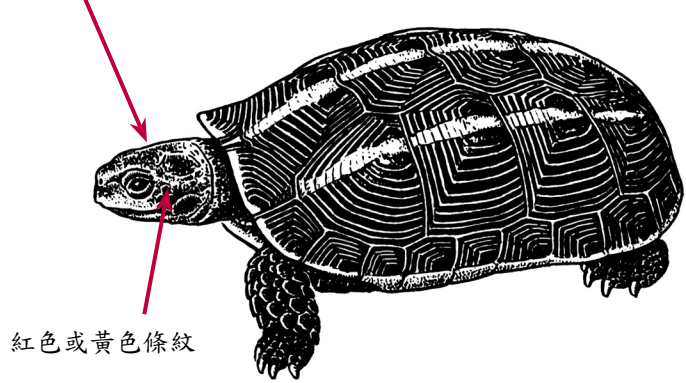

紅色或黃色條紋

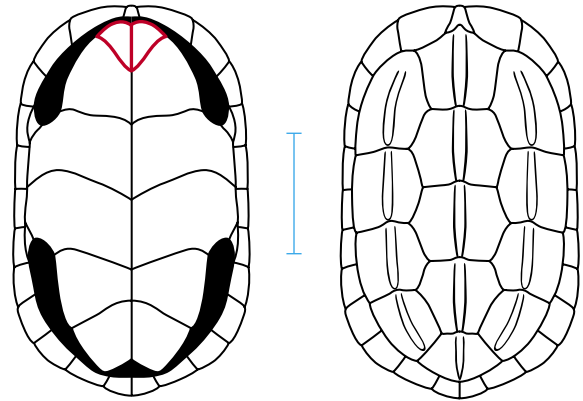

各趾間的蹼長至爪的部位 呈略帶黃色至橘色

👤 *Melanochelys tricarinata*

棕色至黑色並間有橘色或黃色斑點

呈略帶紅的棕色至黑色並具有黃色稜脊

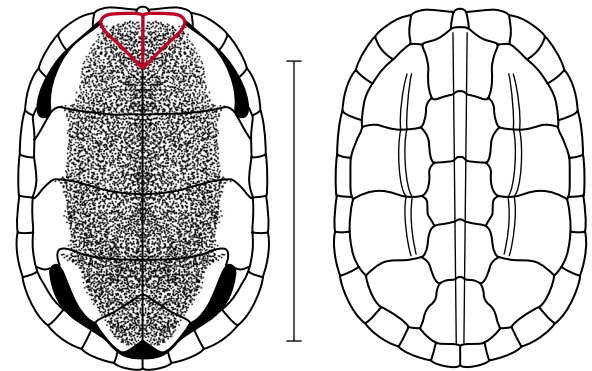
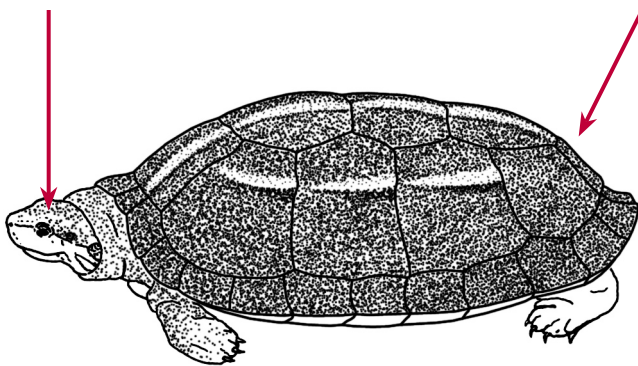

趾間部分有蹼

呈棕色或黑色，部分個體鑲有黃邊

🧑 *Melanochelys trijuga*



黑色並具有黃色條紋

呈棕色並鑲有淺色邊

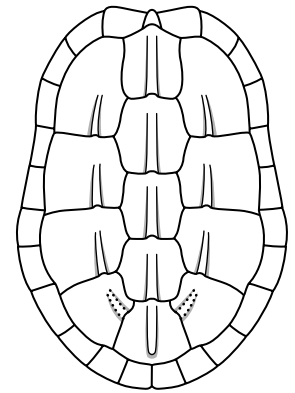
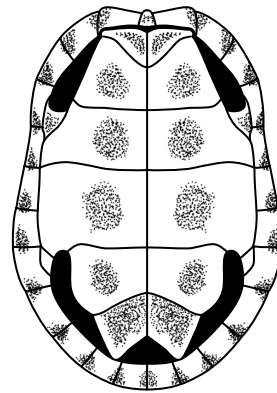
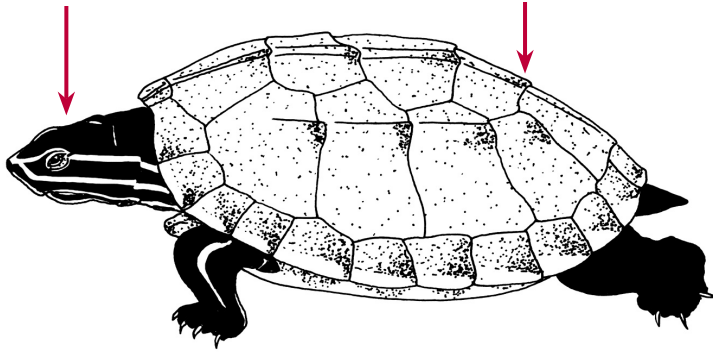

呈黃色或乳白色並具有深色污斑



Malayemys subtrijuga

棕色至黑色並有黃色條紋

稜脊旁顏色較深呈棕色

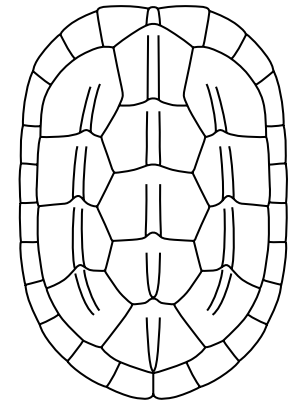
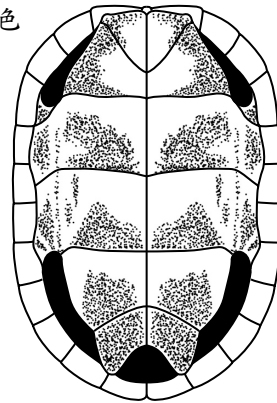
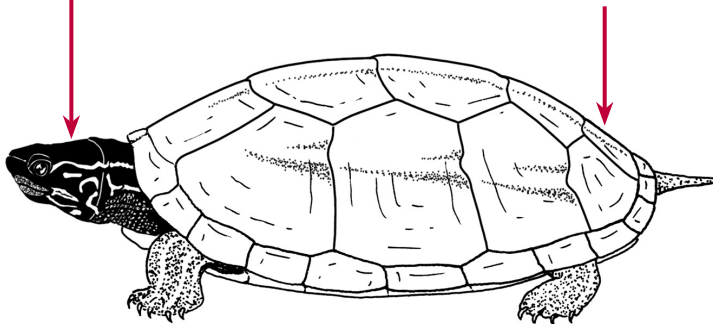

黃色並具有棕色污斑



Chinemys reevesii

棕色至黑色並有黃色條紋

呈深灰色至黑色

肋盾上稜脊隨年齡增長而消失

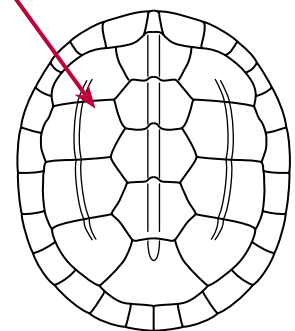
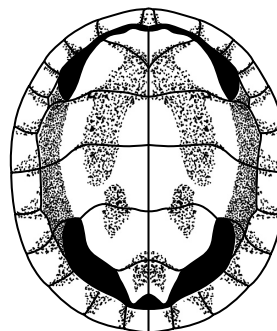
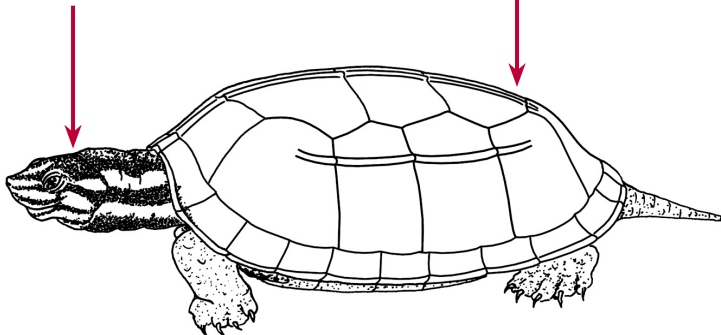

呈黃色至橘色並具有黑色污斑



Annamemys annamensis

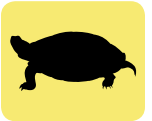

下列種類亦可能具有三道稜脊，
且無鋸齒狀突起

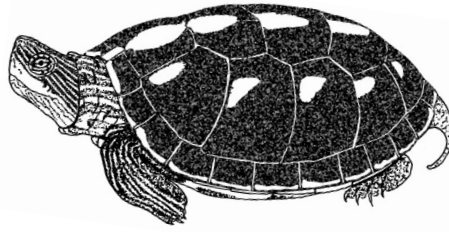

 *Ocadia sinensis* (juv.) 48

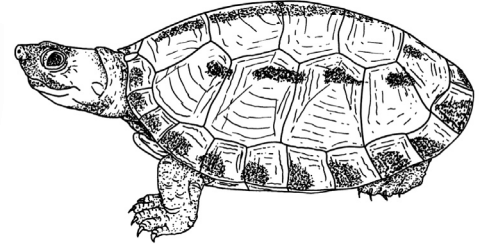

 *Callagur borneoensis* 48

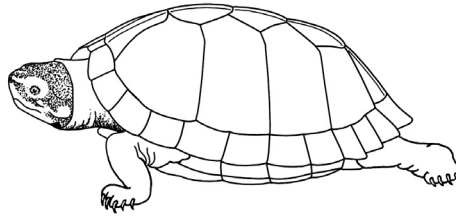

















 *Siebenrockiella crassicollis* (juv.) 54

Orange Section

橘色參考頁

橘色參考頁為需請專家鑑定的
龜類物種及本圖鑑未說明物種
的名錄。



- PE-1  Pelusios adansonii
- PE-2  Pelusios bechuanicus
- PE-3  Pelusios broadleyi
- PE-4  Pelusios carinatus
- PE-5  Pelusios castaneus
- PE-6  Pelusios castanoides
- PE-7  Pelusios chapini
- PE-8  Pelusios gabonensis
- PE-9  Pelusios nanus
- PE-10  Pelusios niger
- PE-11  Pelusios rhodesianus
- PE-12  Pelusios seychellensis
- PE-13  Pelusios sinuatus
- PE-14  Pelusios subniger
- PE-15  Pelusios upembae
- PE-16  Pelusios williamsi

本圖鑑未列入的物種

CHELIDAE

Chelodina expansa
Chelodina longicollis
Chelodina novaeguineae
Chelodina parkeri
Chelodina reimanni
Chelodina rugosa
Chelodina siebenrocki
Chelodina steindachneri

Elseya dentata
Elseya latisternum
Elseya novaeguineae

Emydura australis
Emydura krefftii
Emydura macquarrii
Emydura signata
Emydura victoriae

Phrynops dahli
Phrynops geoffroanus
Phrynops gibbus
Phrynops hilarii
Phrynops hoguei
Phrynops nasutus
Phrynops raniceps
Phrynops rufipes
Phrynops tuberculatus
Phrynops vanderhaegei
Phrynops williamsi
Phrynops zuliae
Pseudemydura umbrina

Rheodytes leukops

PELOMEDUSIDAE

Pelusios adansonii
Pelusios bechuanicus
Pelusios broadleyi
Pelusios carinatus
Pelusios castanoides
Pelusios chapini
Pelusios gabonensis
Pelusios nanus
Pelusios niger
Pelusios rhodesianus
Pelusios seychellensis
Pelusios sinuatus
Pelusios subniger
Pelusios upembae
Pelusios williamsi

EMYDIDAE: BATAGURINAE

Annamemys annamensis

Cuora aurocapitata
Cuora mccordi
Cuora pani
Cuora yunnanensis
Cuora zhoui

Geoemyda silvatica

Hardella thurjii

Heosemys depressa
Heosemys grandis
Heosemys leytenensis
Heosemys spinosa

Kachuga dhongoka
Kachuga kachuga
Kachuga smithii
Kachuga sylhetensis
Kachuga tentoria

Mauremys caspica
Mauremys iversoni
Mauremys japonica
Mauremys leprosa
Mauremys mutica

Ocadia philippeni

Rhinoclemmys annulata
Rhinoclemmys areolata
Rhinoclemmys diademata
Rhinoclemmys funerea
Rhinoclemmys melanosterna
Rhinoclemmys nasuta
Rhinoclemmys pulcherrima
Rhinoclemmys punctularia
Rhinoclemmys rubida

Sacalia bealei

EMYDIDAE: EMYDINAE

Graptemys barbouri
Graptemys caglei
Graptemys flavimaculata
Graptemys nigrinoda
Graptemys ouachitensis
Graptemys pulchra
Graptemys versa

Pseudemys alabamensis
Pseudemys concinna
Pseudemys nelsoni
Pseudemys texana

Trachemys decussata
Trachemys dorbigni

KINOSTERNIDAE

Kinosternon alamosae
Kinosternon angustipons
Kinosternon creaseri
Kinosternon depressum
Kinosternon dunni
Kinosternon herrerae
Kinosternon hirtipes
Kinosternon integrum
Kinosternon oaxacae
Kinosternon sonoriense

Claudius angustatus

Staurotypus salvinii
Staurotypus triporcatus

TESTUDINIDAE

Homopus bergeri
Cycloderma frenatum
Lissemys scutata

TRIONYCHIDAE

Rafetus swinhoei

Index A

附錄A

A

淺灰色附錄頁為附錄A。

附錄A提供本圖鑑內曾敘述的所有龜類物種之學名，學名乃依照字母的順序排列，並附有中英文名。

附錄A

學名

英文名

中文名

<i>Acanthochelys pallidipectoris</i>	Chaco Side-necked Turtle	加哥側頸龜
<i>Acanthochelys radiolata</i>	Brazilian Radiolated Swamp Turtle	巴西放射側頸龜
<i>Acanthochelys spixii</i>	Spiny-neck Turtle	棘頸側頸龜
<i>Amyda cartilaginea</i>	Asiantic Softshell Turtle	亞洲鱉
<i>Annamemys annamensis</i>	Annam Leaf Turtle	安南龜
<i>Apalone ferox</i>	Florida Softshell Turtle	佛羅里達鱉
<i>Apalone mutica</i>	Smooth Softshell Turtle	滑背鱉
<i>Apalone spinifera ater</i>	Black Spiny Softshell Turtle	黑棘鱉
<i>Apalone spinifera spinifera</i>	Eastern Spiny Softshell Turtle	東方棘鱉
<i>Aspideretes gangeticus</i>	Indian Softshell Turtle	印度鱉 (恆河鱉)
<i>Aspideretes hurum</i>	Indian Peacock Softshell Turtle	印度孔雀鱉
<i>Aspideretes leithii</i>	Leith's Softshell Turtle	來氏鱉
<i>Aspideretes nigricans</i>	Black Softshell Turtle	黑鱉
<i>Batagur baska</i>	Batagur	潮龜 (巴達庫爾龜)
<i>Callagur borneoensis</i>	Painted Terrapin	婆羅洲彩龜
<i>Caretta caretta</i>	Loggerhead	赤蠟龜
<i>Carettochelys insculpta</i>	Pig-nose Turtle	豬鼻龜
<i>Chelonia agassizii</i>	Pacific Green Turtle	黑海龜
<i>Chelonia mydas</i>	Common Green Turtle	綠蠟龜 (綠海龜)
<i>Chelus fimbriata</i>	Matamata	馬塔馬塔龜 (楓葉龜)
<i>Chelydra serpentina</i>	Common Snapping Turtle	平板鱷龜
<i>Chersina angulata</i>	South Africa Bowspirit Tortoise	南非陸龜
<i>Chinemys nigricans</i>	Red-necked Pond Turtle	黑頸烏龜
<i>Chinemys reevesii</i>	Reeves' Turtle	金龜 (烏龜)
<i>Chitra indica</i>	Narrow-headed Softshell Turtle	印度小頭鱉
<i>Chrysemys picta</i>	Painted Turtle	錦龜
<i>Clemmys guttata</i>	Spotted Turtle	斑點水龜
<i>Clemmys insculpta</i>	Wood Turtle	木雕水龜
<i>Clemmys marmorata</i>	Pacific Pond Turtle	石紋水龜
<i>Clemmys muhlenbergii</i>	Bog Turtle	牟氏水龜
<i>Cuora amboinensis</i>	Southeast Asian Box Turtle	安布閉殼龜
<i>Cuora flavomarginata</i>	Yellow-margined Box Turtle	食蛇龜 (黃緣閉殼龜)
<i>Cuora galbinifrons</i>	Indochinese Box Turtle	黃額閉殼龜
<i>Cuora trifasciata</i>	Chinese Three-striped Box Turtle	三線閉殼龜
<i>Cyclanorbis elegans</i>	Nubian Flapshell Turtle	努比亞緣板鱉
<i>Cyclanorbis senegalensis</i>	Senegal Flapshell Turtle	塞內加爾緣板鱉
<i>Cyclemys dentata</i>	Asian Leaf Turtle	齒緣攝龜
<i>Cyclemys tcheponensis</i>	Stripe-necked Leaf Turtle	條頸攝龜
<i>Cycloderma aubryi</i>	Aubry's Flapshell Turtle	歐氏圓鱉
<i>Deirochelys reticularia</i>	Chicken Turtle	網斑雞龜
<i>Dermatemys mawii</i>	Central American River Turtle	中美洲河龜
<i>Dermochelys coriacea</i>	Leatherback Turtle	革龜 (棱皮龜)
<i>Dogania subplana</i>	Malayan Softshell Turtle	馬來鱉
<i>Elseya novaeguineae</i>	New Guinea Snapping Turtle	新幾內亞蛇頸龜
<i>Emydoidea blandingii</i>	Blanding's Turtle	布氏擬龜
<i>Emydura subglobosa</i>	Red-bellied Short-necked Turtle	紅腹短頸龜
<i>Emys orbicularia</i>	European Pond Turtle	歐洲池龜
<i>Eretmochelys imbricata</i>	Hawksbill Turtle	玳瑁
<i>Erymnochelys madagascariensis</i>	Madagascan Big-headed Turtle	馬達加斯加大頭側頸龜
<i>Geochelone carbonaria</i>	Red-footed Tortoise	紅腿象龜
<i>Geochelone chilensis</i>	Chaco Tortoise	智利陸龜
<i>Geochelone denticulata</i>	South American Yellow-footed Tortoise	黃腿象龜
<i>Geochelone elegans</i>	Star Tortoise	印度星龜

A

附錄A

學名

英文名

中文名

<i>Geochelone gigantea</i>	Aldabra Tortoise	亞達伯陸龜
<i>Geochelone nigra</i>	Galapagos Tortoise	馬達加斯加象龜
<i>Geochelone pardalis</i>	Leopard Tortoise	豹紋陸龜
<i>Geochelone platynota</i>	Burmese Star Tortoise	緬甸陸龜
<i>Geochelone radiata</i>	Radiated Tortoise	射紋龜 (星龜)
<i>Geochelone sulcata</i>	African Spurred Tortoise	蘇卡達陸龜
<i>Geochelone yniphora</i>	Angonoka	北馬達加斯加陸龜
<i>Geoclemys hamiltonii</i>	Spotted Pond Turtle	斑點池龜
<i>Geoemyda spengleri</i>	Black-breasted Leaf Turtle	地龜 (黑胸葉龜)
<i>Gopherus agassizii</i>	Desert Tortoise	阿氏沙龜
<i>Gopherus berlandieri</i>	Berlandier's Tortoise	貝氏沙龜
<i>Gopherus flavomarginatus</i>	Bolson Tortoise	黃緣沙龜 (黑西哥哥法象龜)
<i>Gopherus polyphemus</i>	Florida Gopher Tortoise	佛羅里達沙龜
<i>Graptemys geographica</i>	Common Map Turtle	地圖龜
<i>Graptemys oculifera</i>	Ringed Map Turtle	眼斑圖龜
<i>Graptemys pseudogeographica</i>	False Map Turtle	偽圖龜
<i>Graptemys pseudogeographica kohnii</i>	Mississippi Map Turtle	密西西比圖龜
<i>Heosemys grandis</i>	Giant Asian Pond Turtle	亞洲巨龜
<i>Heosemys spinosa</i>	Spiny Turtle	刺地龜
<i>Hieremys annandalii</i>	Yellow-headed Temple Turtle	黃頭廟龜
<i>Homopus areolatus</i>	Beaked Cape Tortoise	鈎吻珍龜
<i>Homopus boulengeri</i>	Boulenger's Cape Tortoise	鮑氏珍龜
<i>Homopus femoralis</i>	Karoo Cape Tortoise	卡魯珍龜
<i>Homopus signatus</i>	Speckled Cape Tortoise	斑點珍龜
<i>Hydromedusa maximiliani</i>	Brazilian Snake-necked Turtle	巴西蛇頸龜
<i>Hydromedusa tectifera</i>	South American Snake-necked Turtle	南美蛇頸龜
<i>Indotestudo elongata</i>	Elongated Tortoise	緬甸陸龜 (黃頭象龜)
<i>Indotestudo forstenii</i>	Tranvancore Tortoise	特拉凡爾陸龜
<i>Kachuga tecta</i>	Indian Roofed Turtle	北印度稜背龜 (印度鋸背龜)
<i>Kachuga tentoria</i>	Indian Tent Turtle	南印度稜背龜
<i>Kachuga trivittata</i>	Burmese Roofed Turtle	緬甸稜背龜
<i>Kinixys belliana</i>	Bell's Hinge-back Tortoise	貝爾氏絞龜
<i>Kinixys erosa</i>	Serrated Hinge-back Tortoise	鋸緣絞龜
<i>Kinixys homeana</i>	Home's Hinge-back Tortoise	荷氏絞龜
<i>Kinixys natalensis</i>	Natal Hinge-back Tortoise	那塔耳絞龜
<i>Kinosternon acutum</i>	Tabasco Mud Turtle	斑紋泥龜
<i>Kinosternon baurii</i>	Striped Mud Turtle	紋斑泥龜
<i>Kinosternon carinatum</i>	Razor-backed Musk Turtle	稜背泥龜
<i>Kinosternon flavescens</i>	Yellow Mud Turtle	黃泥龜
<i>Kinosternon leucostomum</i>	White-lipped Mud Turtle	白唇泥龜
<i>Kinosternon scorpioides cruentatum</i>	Red-checked Mud Turtle	紅格泥龜
<i>Kinosternon scorpioides scorpioides</i>	Amazon Mud Turtle	亞馬遜泥龜
<i>Kinosternon subrubrum</i>	Common Mud Turtle	東方泥龜
<i>Lepidochelys kempii</i>	Kemp's Ridley Turtle	肯普氏海龜
<i>Lepidochelys olivacea</i>	Olive Ridley Turtle	欖蠟龜 (太平洋麗龜)
<i>Lissemys punctata</i>	Indian Flapshell Turtle	印度緣板鱉 (印度鱉)
<i>Macrolemys temminckii</i>	Alligator Snapping Turtle	真鱷龜
<i>Malaclemys terrapin</i>	Northern Diamondback Turtle	菱背龜
<i>Malacochersus tornieri</i>	African Pancake Tortoise	多氏陸龜
<i>Malayemys subtrijuga</i>	Malayan Snail-eating Turtle	馬來食螺龜
<i>Manouria emys</i>	Asian Brown Tortoise	亞洲棕龜
<i>Manouria impressa</i>	Impressed Tortoise	凹甲陸龜
<i>Melanochelys tricarinata</i>	Tricarinata Hill Turtle	三稜黑龜 (三龍骨龜)
<i>Melanochelys trijuga</i>	Indian Back Turtle	印度黑龜
<i>Morenia ocellata</i>		

A

附錄A

學名

英文名

中文名

學名	英文名	中文名
<i>Morenia ocellata</i>	Burmese Eyed Turtle	緬甸眼斑沼龜 (緬甸孔雀龜)
<i>Morenia petersi</i>	Indian Eyed Turtle	印度眼斑沼龜
<i>Natator depressa</i>	Flatback Turtle	平背海龜
<i>Nilssonia formosa</i>	Burmese Peacock Softshell Turtle	緬甸孔雀鱉
<i>Notochelys platynota</i>	Malayan Flat-shelled Turtle	馬來果龜
<i>Ocadia sinensis</i>	Chinese Stripe-necked Turtle	斑龜 (中華花龜)
<i>Orlitia borneensis</i>	Malaysian Giant Turtle	馬來西亞巨龜
<i>Palea steindachneri</i>	Wattle-necked Softshell Turtle	山瑞鱉
<i>Pelochelys bibroni</i>	Asian Giant Softshell Turtle	亞洲巨鱉 (龜)
<i>Pelodiscus sinensis</i>	Chinese Softshell Turtle	鱉 (中華鱉)
<i>Pelomedusa subrufa</i>	Helmeted Turtle	紅腹側頸龜
<i>Peltocephalus dumerillianus</i>	Big-headed Amazon River Turtle	亞馬遜大頭側頸龜
<i>Pelusios Spp.</i>	African Hinged Terrapins	非洲側頸龜
<i>Platemys platycephala</i>	Twist-necked Turtle	扁頭側頸龜
<i>Platysternon megacephalum</i>	Big-headed Turtle	大頭龜 (平胸龜)
<i>Podocnemis erythrocephala</i>	Red-headed River Turtle	南美紅頭側頸龜
<i>Podocnemis expansa</i>	South American River Turtle	南美巨側頸龜
<i>Podocnemis lewyana</i>	Magdalena River Turtle	馬格林達那河側頸龜
<i>Podocnemis sextuberculata</i>	Six-tubercled River Turtle	六疣側頸龜
<i>Podocnemis unifilis</i>	Yellow-spotted River Turtle	黃點側頸龜
<i>Podocnemis vogli</i>	Savanna Side-necked Turtle	草原側頸龜
<i>Psammobates geometricus</i>	Geometric Tortoise	幾何陸龜 (星叢龜)
<i>Psammobates oculiferus</i>	Serrated Tortoise	眼斑陸龜
<i>Psammobates tentorius</i>	Tent Tortoise	脊稜陸龜
<i>Pseudemydura umbrina</i>	Western Swamp Turtle	短頸龜 (澳洲短頸龜)
<i>Pseudemys floridana</i>	Common Cooter	佛羅里達彩龜
<i>Pseudemys rubriventris</i>	American Red-bellied Turtle	紅腹彩龜
<i>Pyxidea mouhotii</i>	Keeled Box Turtle	鋸緣攝龜
<i>Pyxis arachnoides</i>	Common Spider Tortoise	蛛龜
<i>Pyxis planicauda</i>	Flat-shelled Spider Tortoise	平背蛛龜
<i>Rafetus euphraticus</i>	Euphrates Softshell Turtle	幼發拉底河鱉
<i>Sacalia bealei</i>	Beal's-eyed Turtle	眼斑水龜
<i>Sacalia quadriocellata</i>	Four-eyed Turtle	四眼斑水龜
<i>Siebenrockiella crassicollis</i>	Black Marsh Turtle	粗頸龜
<i>Sternotherus minor</i>	Loggerhead Musk Turtle	大頭麝龜
<i>Stenotherus odoratus</i>	Common Musk Turtle	麝龜
<i>Terrapene carolina</i>	Common Box Turtle	卡羅萊那箱龜
<i>Terrapene coahuila</i>	Coahuila Box Turtle	沼澤箱龜
<i>Terrapene nelsoni</i>	Spotted Box Turtle	斑點箱龜
<i>Terrapene ornata</i>	Ornata Box Turtle	錦箱龜
<i>Testudo graeca</i>	Spur-thighed Tortoise	地中海陸龜
<i>Testudo hermanni</i>	Hermann's Tortoise	赫氏陸龜
<i>Testudo horsfieldii</i>	Central Asian Tortoise	四爪陸龜
<i>Testudo kleimanii</i>	Egyptian Tortoise	埃及陸龜 (克萊馬尼龜)
<i>Testudo marginata</i>	Marginated Tortoise	希臘陸龜
<i>Trachemys decorata</i>	Hispaniolan Slider	希斯培尼歐拉彩龜
<i>Trachemys scripta</i>	Common Slider	黃腹彩龜
<i>Trachemys stejnegeri</i>	Common Antillean Slider	安地列斯彩龜
<i>Trachemys terrapen</i>	Jamaican Slider	牙買加彩龜
<i>Trionyx triunguis</i>	African Softshell Turtle	非洲三爪鱉

A

Index B

附錄B

深灰色附錄頁為附錄B。

附錄B依英文字母排列
順序列出每一物種的學
名與英文名，及該物種
在圖鑑中出現的頁碼。

縮寫說明

N.C 非CITES物種

C CITES物種
(依據1997CITES物種名錄)

科名縮寫

CA	Carettochelyidae
CI	Chelidae
CH	Cheloniidae
CY	Chelydridae
DE	Dermatemydidae
DO	Dermochelyidae
EM	Emydidae
KI	Kinosternidae
PE	Pelomedusidae
PT	Platysternidae
TE	Testudinidae
TR	Trionychidae

*符號表示物種或亞種在本圖鑑未說明

見 **?-18**

附錄B

英文名	學名	管制,科名	藍	黃	橘
Abingdon Island Tortoise	<i>Geochelone nigra abingdonii</i>	C, TE		2*	
Acanthochelys pallidipectoris	<i>Acanthochelys pallidipectoris</i>	N.C, CI		26	
Acanthochelys radiolata	<i>Acanthochelys radiolata</i>	N.C, CI		26	
Acanthochelys spixii	<i>Acanthochelys spixii</i>	N.C, CI		26	
Acanthochelys Spp.	<i>Acanthochelys Spp.</i>	N.C, CI		26	
Acinisside	<i>Pyxis planicauda</i>	C, TE		18	
Acinixys planicauda	<i>Pyxis planicauda</i>	C, TE		18	
Adanson's Mud Turtle	<i>Pelusios adansonii</i>	C, PE-1		30*	1
Afghan Tortoise	<i>Testudo horsfieldii</i>	C, TE		17	
African Black Terrapin	<i>Pelusios niger</i>	C, PE-10		30*	1
African bungoma	<i>Cyclanorbis senegalensis</i>	N.C, TR	7		
African Dwarf Mud Turtle	<i>Pelusios nanus</i>	N.C, PE-9		30*	1
African Flap-shell Turtle(s)	<i>Cyclanorbis Spp.</i>	N.C, TR	7		
African Forest Tortoise(s)	<i>Kinixys Spp.</i>	C, TE	5		
African Forest Turtle	<i>Pelusios gabonensis</i>	C, PE-8		30*	1
African Helmeted Turtle	<i>Pelomedusa subrufa</i>	C, PE		30	
African Hinged Terrapin(s)	<i>Pelusios Spp.</i>	N.C-C, PE		30	1
African Keeled Mud Turtle	<i>Pelusios carinatus</i>	N.C, PE-4		30*	1
African Mud Turtle	<i>Pelusios castaneus</i>	C, PE-5		30	1
African Mud Turtle	<i>Pelusios subniger</i>	C, PE-14		30*	1
African Mud Turtle(s)	<i>Pelusios Spp.</i>	N.C-C, PE		30	1
African Pancake Tortoise	<i>Malacochersus tornieri</i>	C, TE		7	
African Serrated Tortoise	<i>Psammobates oculiferus</i>	C, TE		6	
African Side-neck Turtle	<i>Pelusios castaneus</i>	C, PE-5		30	1
African Side-necked Turtle(s)	<i>Pelusios Spp.</i>	N.C-C, PE		30	1
African Soft-shell Turtle	<i>Trionyx triunguis</i>	C, TR		23	
African Soft-shell Turtle(s)	<i>Cyclanorbis Spp.</i>	N.C, TR	7		
African Spur Thigh Tortoise	<i>Geochelone sulcata</i>	C, TE		10	
African Spurred Tortoise	<i>Geochelone sulcata</i>	C, TE		10	
African Tent Tortoise	<i>Psammobates tentorius</i>	C, TE		6	
Afro-American Side-necked Turtle(s)	<i>Pelusios Spp.</i>	N.C-C, PE		30 - 33	1
Albert Nile Mud Turtle	<i>Pelusios williamsii lutescens</i>	N.C, PE-16		30*	1
Albino Alligator Snapping Turtle	<i>Macroclemys temminckii</i>	N.C, CY	8		
Aldabra Tortoise	<i>Geochelone gigantea</i>	C, TE		2	
Aldabran Giant Tortoise	<i>Geochelone gigantea</i>	C, TE		2	
Alligator Snapper	<i>Macroclemys temminckii</i>	N.C, CY	8		
Alligator Snapping Turtle	<i>Macroclemys temminckii</i>	N.C, CY	8		
Amazon Mud Turtle	<i>Kinosternon scorpioides scorpioides</i>	N.C, KI		38	
American Freshwater Turtle(s)	<i>Clemmys Spp.</i>	N.C-C, EM		49, 54	
American Mud Turtle(s)	<i>Kinosternon Spp.</i>	N.C, KI		34 - 38	
American Musk Turtle(s)	<i>Kinosternon Spp.</i>	N.C, KI		34 - 38	
American Pond Turtle(s)	<i>Clemmys Spp.</i>	N.C-C, EM		49, 54	
American Pond Turtle	<i>Emydoidea blandingii</i>	N.C, EM		45	
American Red-bellied Turtle	<i>Pseudemys rubriventris</i>	N.C, EM		46	
American River Turtle(s)	<i>Podocnemis Spp.</i>	C, PE		32, 33	
American Soft-shelled Turtle	<i>Apalone spinifera</i>	N.C, TR		13	
Amyda cartilaginea	<i>Amyda cartilaginea</i>	N.C, TR		23	
Amyda ferox	<i>Apalone ferox</i>	N.C, TR		24	
Anamurum Spur-thighed Tortoise	<i>Testudo graeca anamurensis</i>	C, TE		16*	
Angonoka Radiated Tortoise	<i>Geochelone yniphora</i>	C, TE		13	
Angonoka	<i>Geochelone yniphora</i>	C, TE		13	
Angulated Tortoise	<i>Chersina angulata</i>	C, TE		19	
Annam Leaf Turtle	<i>Annamemys annamensis</i>	N.C, EM		62	
Annamemys annamensis	<i>Annamemys annamensis</i>	N.C, EM		62	
Annandal's Turtle	<i>Hieremys annandalii</i>	N.C, EM		56	
Antillean Slider	<i>Chrysemys picta</i>	N.C, EM		50	
Apalone ater	<i>Apalone spinifera ater</i>	C, TR		24	
Apalone ferox	<i>Apalone ferox</i>	N.C, TR		24	
Apalone mutica	<i>Apalone mutica</i>	N.C, TR		25	
Apalone spinifera ater	<i>Apalone spinifera ater</i>	C, TR		24	
Apalone spinifera	<i>Apalone spinifera</i>	N.C, TR		13	
Apalone Spp.	<i>Apalone Spp.</i>	N.C-C, TR		24, 25	
Aquatic Box Turtle	<i>Terrapene coahuila</i>	C, EM		43	
Areolated Tortoise	<i>Homopus areolatus</i>	C, TE		14	
Argentine Land Tortoise	<i>Geochelone chilensis</i>	C, TE		11	
Argentine Mud Turtle	<i>Kinosternon scorpioides seriei</i>	N.C, KI		38*	
Argentine Snake-necked Terrapin	<i>Hydromedusa tectifera</i>	N.C, CI		28	
Argentine Snake-necked Turtle	<i>Hydromedusa tectifera</i>	N.C, CI		28	

*符號表示物種或亞種在本圖鑑未說明

附錄B

英文名	學名	管制,科名	藍	黃	橘
Argentine Tortoise	<i>Geochelone chilensis</i>	C, TE		11	
Argentinian Tortoise	<i>Geochelone chilensis</i>	C, TE		11	
Arizona Mud Turtle	<i>Kinosternon flavescens arizonense</i>	N.C, KI		34*	
Arrau River Turtle	<i>Podocnemis expansa</i>	C, PE		32	
Arrau Sideneck	<i>Podocnemis expansa</i>	C, PE		32	
Arrau Turtle	<i>Podocnemis expansa</i>	C, PE		32	
Arrau Turtle(s)	<i>Podocnemis Spp.</i>	C, PE		32, 33	
Arrau	<i>Podocnemis expansa</i>	C, PE		32	
Asia Minor Spur-thighed Tortoise	<i>Testudo graeca iberica</i>	C, TE		16*	
Asian Box Turtle	<i>Cuora amboinensis</i>	N.C, EM		42	
Asian Box Turtle(s)	<i>Cuora Spp.</i>	N.C, EM		41, 42	
Asian Brown Tortoise	<i>Manouria emys</i>	C, TE		13	
Asian Giant Softshell Turtle	<i>Pelochelys bibroni</i>	N.C, TR		25	
Asian Giant Soft-shelled Turtle	<i>Pelochelys bibroni</i>	N.C, TR		25	
Asian Leaf Turtle	<i>Cyclemys dentata</i>	N.C, EM		40	
Asian Leaf Turtle(s)	<i>Cyclemys Spp.</i>	N.C, EM		40, 54	
Asian Tortoise(s)	<i>Indotestudo Spp.</i>	C, TE		10, 17	
Asiatic Geoemyda	<i>Melanochelys trijuga</i>	N.C, EM		61	
Asiatic Softshell Turtle	<i>Amyda cartilaginea</i>	N.C, TR		23	
Aspideretes gangeticus	<i>Aspideretes gangeticus</i>	C, TR		21	
Aspideretes hurum	<i>Aspideretes hurum</i>	C, TR		21	
Aspideretes leithii	<i>Aspideretes leithii</i>	N.C, TR		21	
Aspideretes nigricans	<i>Aspideretes nigricans</i>	C, TR		22	
Aspideretes Spp.	<i>Aspideretes Spp.</i>	N.C-C, TR		21, 22	
Astrochelys hyniphora	<i>Geochelone yniphora</i>	C, TE		13	
Astrochelys radiata	<i>Geochelone radiata</i>	C, TE		5	
Astrochelys Spp.	<i>Geochelone Spp.</i>	C, TE		5, 13	
Astrochelys yniphora	<i>Geochelone yniphora</i>	C, TE		13	
Atlantic Green Turtle	<i>Chelonia mydas</i>	C, CH	2		
Atlantic Hawksbill Turtle	<i>Eretmochelys imbricata imbricata</i>	C, CH	2		
Atlantic Hawksbill	<i>Eretmochelys imbricata</i>	C, CH	2		
Atlantic Leatherback	<i>Dermochelys coriacea</i>	C, DO	4		
Atlantic Loggerhead	<i>Caretta caretta</i>	C, CH	3		
Atlantic Ridley	<i>Lepidochelys kempii</i>	C, CH	3		
Aubry's Flapshell Turtle	<i>Cycloderma aubryi</i>	N.C, TR	6		
Aubry's Soft-shell Turtle	<i>Cycloderma aubryi</i>	N.C, TR	6		
Austral River Turtle(s)	<i>Elseya Spp.</i>	N.C, CI		29	
Australian Short-necked Turtle(s)	<i>Emydura Spp.</i>	N.C, CI		29	
Australian Snapping Turtle(s)	<i>Elseya Spp.</i>	N.C, CI		29	
Australo-American Side-necked Turtle(s)	<i>Acanthochelys Spp.</i>	N.C-C, CI		26 - 29	
Austro-American Side-necked Turtle(s)	<i>Acanthochelys Spp.</i>	N.C-C, CI		26 - 29	
B					
Baby Red Ear Slider	<i>Trachemys scripta</i>	N.C, EM		52	
Baja California Slider	<i>Trachemys scripta nebulosa</i>	N.C, EM		52*	
Bastard Turtle	<i>Lepidochelys kempii</i>	C, CH	3		
Batacle	<i>Dermochelys coriacea</i>	C, DO	4		
Batagur	<i>Batagur baska</i>	C, EM		47	
Beaked Cape Tortoise	<i>Homopus areolatus</i>	C, TE		14	
Beal's-eyed Turtle	<i>Sacalia bealei</i>	N.C, EM		57	
Beale's eyed Turtle	<i>Sacalia bealei</i>	N.C, EM		57	
Bell's Hinged-backed Turtle	<i>Kinixys belliana</i>	C, TE	5		
Bell's Eastern Hinged Tortoise	<i>Kinixys belliana</i>	C, TE	5		
Bell's Hinge-back Tortoise	<i>Kinixys belliana</i>	C, TE	5		
Bells Hinge-backed Tortoise	<i>Kinixys belliana</i>	C, TE	5		
Bell's Hinged Tortoise	<i>Kinixys belliana</i>	C, TE	5		
Bengal Black Turtle	<i>Melanochelys trijuga indopeninsularis</i>	N.C, EM		61*	
Bengal Eyed Terrapin	<i>Morenia ocellata</i>	C, EM		58	
Berlandier's Tortoise	<i>Gopherus berlandieri</i>	C, TE		12	
Bibron's Trionychine Turtle	<i>Pelochelys bibroni</i>	N.C, TR		25	
Bicallosite Softshell Turtle	<i>Rafetus euphraticus</i>	N.C, TR		22	
Bicallosite Softshell Turtle	<i>Rafetus Spp.</i>	N.C, TR		22	
Big Bend Slider	<i>Trachemys scripta gaigeae</i>	N.C, EM		52*	
Big Bend Turtle	<i>Trachemys scripta</i>	N.C, EM		52	
Big-headed Amazon River Turtle	<i>Peltocephalus dumerilianus</i>	C, PE		31	
Big-headed River Turtle	<i>Platysternon megacephalum</i>	N.C, PT	9		
Big-headed Sideneck	<i>Peltocephalus dumerilianus</i>	C, PE		31	
Big-headed Turtle	<i>Platysternon megacephalum</i>	N.C, PT	9		
Black Giant Tortoise	<i>Manouria emys</i>	C, TE		13	

*符號表示物種或亞種在本圖鑑未說明

附錄B

英文名	學名	管制,科名	藍	黃	橘
Black Helmeted Turtle	<i>Pelomedusa subrufa nigra</i>	C, PE		30*	
Black Marsh Turtle	<i>Siebenrockiella crassicollis</i>	N.C, EM		54	
Black Pelomedusid Turtle	<i>Pelusios niger</i>	C, PE-10		30*	1
Black Pond Turtle	<i>Geoclemys hamiltonii</i>	C, EM		60	
Black Pond Turtle	<i>Siebenrockiella crassicollis</i>	N.C, EM		54	
Black Soft-shell Turtle	<i>Apalone spinifera ater</i>	C, TR		24	
Black Softshell Turtle	<i>Aspideretes nigricans</i>	C, TR		22	
Black Spine-neck Swamp Turtle	<i>Acanthochelys spixii</i>	N.C, CI		26	
Black Spiny-necked Swamp Turtle	<i>Acanthochelys spixii</i>	N.C, CI		26	
Black Spiny Soft-shell Turtle	<i>Apalone spinifera ater</i>	C, TR		24	
Black Spotted Turtle	<i>Geoclemys hamiltonii</i>	C, EM		60	
Black Turtle	<i>Siebenrockiella crassicollis</i>	N.C, EM		54	
Black-backed Twist-necked Turtle	<i>Platemys platycephala melanonota</i>	N.C, CI		27*	
Black-bellied Terrapin	<i>Melanochelys trijuga</i>	N.C, EM		61	
Black-breasted Leaf Turtle	<i>Geoemyda spengleri</i>	N.C, EM		60	
Black-rayed Soft-shell Turtle	<i>Amyda cartilaginea</i>	N.C, TR		23	
Blak Side-necked Turtle	<i>Pelusios niger</i>	C, PE-10		30*	1
Blanding's Turtle	<i>Emydoidea blandingii</i>	N.C, EM		45	
Bog Turtle	<i>Clemmys muhlenbergii</i>	C, EM		49	
Bolson Tortoise	<i>Gopherus flavomarginatus</i>	C, TE		19	
Bornean River Turtle	<i>Orlitia borneensis</i>	N.C, EM		47	
Bostami Turtle	<i>Aspideretes nigricans</i>	C, TR		22	
Boulenger's Cape Tortoise	<i>Homopus boulengeri</i>	C, TE		3	
Bowsprit Tortoise	<i>Chersina angulata</i>	C, TE		19	
Box Turtle	<i>Terrapene carolina</i>	C, EM		43	
Box Turtle(s)	<i>Terrapene Spp.</i>	C, EM		43, 44	
Brasilian Snake-necked Turtle	<i>Hydromedusa maximiliani</i>	N.C, CI		28	
Brazilian Giant Tortoise	<i>Geochelone denticulata</i>	C, TE		9	
Brazilian Radiolated Swamp Turtle	<i>Acanthochelys radiolata</i>	N.C, CI		26	
Broadley's Mud Turtle	<i>Pelusios broadleyi</i>	N.C, PE-3		30*	1
Brown Pelomedusid Turtle	<i>Pelusios castaneus</i>	C, PE-5		30	1
Brown Tortoise	<i>Manouria emys emys</i>	C, TE		13	
Burma Big-headed Turtle	<i>Platysternon m. peguense</i>	N.C, PT	9*		
Burmese Black Tortoise	<i>Manouria emys phayrei</i>	C, TE		13*	
Burmese Black Turtle	<i>Melanochelys trijuga edeniana</i>	N.C, EM		61*	
Burmese Brown Tortoise	<i>Manouria emys</i>	C, TE		13	
Burmese Eyed Turtle	<i>Morenia ocellata</i>	C, EM		58	
Burmese Mountain Tortoise	<i>Manouria emys</i>	C, TE		13	
Burmese Peacock Softshell Turtle	<i>Nilssonina formosa</i>	N.C, TR		21, 23	
Burmese Roofed Turtle	<i>Kachuga trivittata</i>	N.C, EM		57	
Burmese Star Tortoise	<i>Geochelone platynota</i>	C, TE		5	
Burmese Starred Tortoise	<i>Geochelone platynota</i>	C, TE		5	
Burmese Swamp Turtle	<i>Morenia ocellata</i>	C, EM		58	
Burmese Tortoise	<i>Geochelone platynota</i>	C, TE		5	
C					
California Pond Turtle	<i>Clemmys marmorata</i>	N.C, EM		49	
Californian Desert Tortoise	<i>Gopherus agassizi</i>	C, TE		12	
Callagur borneoensis	<i>Callagur borneoensis</i>	N.C, EM		48	
Callagur Turtle	<i>Callagur borneoensis</i>	N.C, EM		48	
Canal	<i>Dermochelys coriacea</i>	C, DO	4		
Cape Berkeley Giant Tortoise	<i>Geochelone nigra becki</i>	C, TE		2*	
Cape Geometric Tortoise	<i>Psammobates geometricus</i>	C, TE		6	
Cape Terrapin	<i>Pelomedusa subrufa</i>	C, PE		30	
Cape Tortoise(s)	<i>Homopus Spp.</i>	C, TE		3, 14, 18	
Caretta caretta	<i>Caretta caretta</i>	C, CH	3		
Caretta(s)	<i>Lepidochelys Spp.</i>	C, CH	3		
Carey	<i>Eretmochelys imbricata</i>	C, CH	2		
Carolina Diamondback Terrapin	<i>Malaclemys terrapin centrata</i>	N.C, EM		58*	
Cartilaginous Soft-shell Turtle	<i>Amyda cartilaginea</i>	N.C, TR		23	
Celebes Tortoise	<i>Indotestudo forstenii</i>	C, TE		10	
Cental American River Turtle	<i>Dermatemys mawii</i>	C, DE		39	
Central African Flapshell Turtle(s)	<i>Cycloderma Spp.</i>	N.C, TR	6		
Central African Mud Turtle	<i>Pelusios chapini</i>	N.C, PE-7		30*	1
Central American Snapping Turtle	<i>Chelydra serpentina rosignoni</i>	N.C, CY	8*		
Central Antillean Slider	<i>Trachemys stejnegeri</i>	N.C, EM		56	
Central Asian Tortoise	<i>Testudo horsfieldii horsfieldii</i>	C, TE		17	
Central Chipas Mud Turtle	<i>Kinosternon scorpioides abaxillare</i>	N.C, KI		38*	
Central Turkey Pond Turtle	<i>Emys orbicularis luteofusca</i>	N.C, EM		45*	
Cerro Azul Giant Tortoise	<i>Geochelone nigra</i>	C, TE		2	

*符號表示物種或亞種在本圖鑑未說明

附錄B

英文名	學名	管制,科名	藍	黃	橘
Cerro Azul Tortoise	<i>Geochelone nigra nigra</i>	C, TE		2	
Ceylon Terrapin	<i>Melanochelys trijuga</i>	N.C, EM		61	
Chaco Sideneck Turtle	<i>Acanthochelys pallidipectoris</i>	N.C, CI		26	
Chaco Side-necked Turtle	<i>Acanthochelys pallidipectoris</i>	N.C, CI		26	
Chaco Tortoise	<i>Geochelone chilensis</i>	C, TE		11	
Chaco Twist-neck Turtle	<i>Acanthochelys pallidipectoris</i>	N.C, CI		26	
Chatham Island Giant Tortoise	<i>Geochelone nigra chathamensis</i>	C, TE		2*	
Chatham Island Tortoise	<i>Geochelone nigra chathamensis</i>	C, TE		2*	
Chelonia mydas	<i>Chelonia mydas</i>	C, CH	2		
Chelonia Spp.	<i>Chelonia Spp.</i>	C, CH	2		
Chelonoides carbonaria	<i>Geochelone carbonaria</i>	C, TE		9	
Chelonoides chilensis	<i>Geochelone chilensis</i>	C, TE		11	
Chelonoides denticulata	<i>Geochelone denticulata</i>	C, TE		9	
Chelus fimbriata	<i>Chelus fimbriata</i>	N.C, CI		29	
Chelydra serpentina	<i>Chelydra serpentina</i>	N.C, CY	8		
Chelydridae	<i>Chelydra Sp.</i>	N.C, CY	8		
Chersina angulata	<i>Chersina angulata</i>	C, TE		19	
Chersina	<i>Chersina angulata</i>	C, TE		19	
Chesnut Terrapin	<i>Pelusios castaneus</i>	C, PE-5		30	1
Chiapas Mud Turtle	<i>Kinosternon scorpioides abaxillare</i>	N.C, KI		38*	
Chicken Turtle	<i>Deirochelys reticularia</i>	N.C, EM		47	
Chilean Tortoise	<i>Geochelone chilensis</i>	C, TE		11	
Chine Three-striped	<i>Cuora trifasciata</i>	N.C, EM		41	
Chinemys nigricans	<i>Chinemys nigricans</i>	N.C, EM		60	
Chinemys reevesii	<i>Chinemys reevesii</i>	N.C, EM		62	
Chinese Big-headed Turtle	<i>Platysternon m. megacephalum</i>	N.C, PT	9		
Chinese Pond Turtle(s)	<i>Chinemys Spp.</i>	N.C, EM		60, 62	
Chinese Redneck Turtle(s)	<i>Chinemys Spp.</i>	N.C, EM		60, 62	
Chinese Soft-shell Turtle	<i>Pelodiscus sinensis</i>	N.C, TR		22	
Chinese Striped-neck Turtle	<i>Ocadia sinensis</i>	N.C, EM		48	
Chinese Striped-necked Turtle(s)	<i>Ocadia Spp.</i>	N.C, EM		48	
Chinese Swamp Turtle(s)	<i>Chinemys Spp.</i>	N.C, EM		60, 62	
Chinese Three-keeled Pond Turtle	<i>Chinemys reevesii</i>	N.C, EM		62	
Chinese Three-striped Box Turtle	<i>Cuora trifasciata</i>	N.C, EM		41	
Chinese Yellow-margined Box Turtle	<i>Cuora flavomarginata sinensis</i>	N.C, EM		42*	
Chitra indica	<i>Chitra indica</i>	N.C, TR		25	
Chittagong Soft-shell Turtle	<i>Aspideretes nigricans</i>	C, TR		22	
Chrysemys picta	<i>Chrysemys picta</i>	N.C, EM		50	
Chrysemys rubriventris	<i>Pseudemys rubriventris</i>	N.C, EM		46	
Clemmyde(s)	<i>Clemmys Spp.</i>	N.C-C, EM		49, 54	
Clemmys guttata	<i>Clemmys guttata</i>	N.C, EM		49	
Clemmys insculpta	<i>Clemmys insculpta</i>	C, EM		54	
Clemmys marmorata	<i>Clemmys marmorata</i>	N.C, EM		49	
Clemmys muhlenbergi	<i>Clemmys muhlenbergii</i>	C, EM		49	
Clemmys Spp.	<i>Clemmys Spp.</i>	N.C-C, EM		49, 54	
Coahuila Box Turtle	<i>Terrapene coahuila</i>	C, EM		43	
Coahuila Turtle	<i>Terrapene coahuila</i>	C, EM		43	
Coahuilan Box Turtle	<i>Terrapene coahuila</i>	C, EM		43	
Coal Tortoise	<i>Geochelone carbonaria</i>	C, TE		9	
Coastal Plain Turtle	<i>Pseudemys floridana</i>	N.C, EM		50	
Cochin Black Turtle	<i>Melanochelys trijuga coronata</i>	N.C, EM		61*	
Colombian Slider	<i>Trachemys scripta callirostris</i>	N.C, EM		52*	
Common African Helmeted Turtle	<i>Pelomedusa subrufa subrufa</i>	C, PE		30	
Common Batagur Turtle	<i>Batagur baska</i>	C, EM		47	
Common Black-breasted Leaf Turtle	<i>Geoemyda spengleri spengleri</i>	N.C, EM		60	
Common Box Turtle	<i>Terrapene carolina</i>	C, EM		43	
Common Cooter	<i>Pseudemys floridana floridana</i>	N.C, EM		50	
Common European Pond Turtle	<i>Emys orbicularis orbicularis</i>	N.C, EM		45	
Common Forest Tortoise	<i>Kinixys erosa</i>	C, TE	5		
Common Freshwater Turtle(s)	<i>Pseudemys Spp.</i>	N.C-C, EM		40 - 63	
Common Green Turtle	<i>Chelonia mydas</i>	C, CH	2		
Common Hinged Tortoise	<i>Kinixys erosa</i>	C, TE	5		
Common Map Turtle	<i>Graptemys geographica</i>	N.C, EM		51	
Common Mud Turtle	<i>Kinosternon subrubrum</i>	N.C, KI		35	
Common Musk Turtle	<i>Sternotherus odoratus</i>	N.C, KI		35	
Common Musk Turtle(s)	<i>Sternotherus Spp.</i>	N.C, KI		35, 36	
Common River Terrapin	<i>Batagur baska baska</i>	C, EM		47	
Common Slider	<i>Trachemys scripta</i>	N.C, EM		52	

*符號表示物種或亞種在本圖鑑未說明

附錄B

英文名	學名	管制,科名	藍	黃	橘
Common Snapping Turtle	<i>Chelydra serpentina serpentina</i>	N.C, CY	8		
Common Spider Tortoise	<i>Pyxis arachnoides arachnoides</i>	C, TE		7	
Common Tent Tortoise	<i>Psammobates tentorius tentorius</i>	C, TE		6	
Common Tortoise	<i>Testudo graeca</i>	C, TE		16	
Common Twist-necked Turtle	<i>Platemys platycephala platycephala</i>	N.C, CI		27	
Common Yellow-marginated Box Turtle	<i>Cuora flavomarginata flavomarginata</i>	N.C, EM		42	
Congo Pelomedusid Turtle	<i>Pelusios carinatus</i>	N.C, PE-4		30*	1
Cooter Turtle(s)	<i>Pseudemys Spp.</i>	N.C, EM		46, 50	
Cooter	<i>Chrysemys picta</i>	N.C, EM		50	
Cooter	<i>Pseudemys floridana</i>	N.C, EM		50	
Cooter(s)	<i>Pseudemys Spp.</i>	N.C, EM		46, 50	
Cotorra	<i>Lepidochelys kempii</i>	C, CH	3		
Crevice Tortoise	<i>Malacochersus tornieri</i>	C, TE		7	
Cryptopus Aubryi	<i>Cycloderma aubryi</i>	N.C, TR	6		
Cryptopus Senegalensis	<i>Cyclanorbis senegalensis</i>	N.C, TR	7		
Cuatro Cienegas Soft-shell Turtle	<i>Apalone spinifera ater</i>	C, TR		24	
Cuatrocieneegas Slider	<i>Trachemys scripta taylori</i>	N.C, EM		52*	
Cumberland Slider	<i>Trachemys scripta troostii</i>	N.C, EM		52*	
Cuora amboinensis	<i>Cuora amboinensis</i>	N.C, EM		42	
Cuora flavomarginata	<i>Cuora flavomarginata</i>	N.C, EM		42	
Cuora galbinifrons	<i>Cuora galbinifrons</i>	N.C, EM		41	
Cuora hainanensis	<i>Cuora galbinifrons hainensis</i>	N.C, EM		41*	
Cuora Spp.	<i>Cuora Spp.</i>	N.C, EM		41, 42	
Cuora trifasciata	<i>Cuora trifasciata</i>	N.C, EM		41	
Cupiso	<i>Podocnemis sextuberculata</i>	C, PE		33	
Cyclanorbis elegans	<i>Cyclanorbis elegans</i>	N.C, TR	7		
Cyclanorbis senegalensis	<i>Cyclanorbis senegalensis</i>	N.C, TR	7		
Cyclanorbis Spp.	<i>Cyclanorbis Spp.</i>	N.C, TR	7		
Cyclemyde(s)	<i>Cyclemys Spp.</i>	N.C, EM		40, 54	
Cyclemys dentata	<i>Cyclemys dentata</i>	N.C, EM		40	
Cyclemys Spp.	<i>Cyclemys Spp.</i>	N.C, EM		40, 54	
Cyclemys tchepouensis	<i>Cyclemys tchepouensis</i>	N.C, EM		54	
Cycloderma aubryi	<i>Cycloderma aubryi</i>	N.C, TR	6		
Cycloderma Spp.	<i>Cycloderma Spp.</i>	N.C, TR	6		
D					
Dark Soft-shell Turtle	<i>Aspideretes nigricans</i>	C, TR		22	
Deep-grooved Tortoise	<i>Homopus areolatus</i>	C, TE		14	
Deirochelys reticularia	<i>Deirochelys reticularia</i>	N.C, EM		47	
Dermatemide	<i>Dermatemys mawii</i>	C, DE		39	
Dermatemydidae	<i>Dermatemys mawii</i>	C, DE		39	
Dermatemys maiori	<i>Dermatemys mawii</i>	C, DE		39	
Dermatemys mawii	<i>Dermatemys mawii</i>	C, DE		39	
Dermochelide coriacea	<i>Dermochelys coriacea</i>	C, DO	4		
Dermochelys coriacea	<i>Dermochelys coriacea</i>	C, DO	4		
Desert Box Turtle	<i>Terrapene ornata luteola</i>	C, EM		44*	
Desert Tortoise	<i>Gopherus agassizi</i>	C, TE		12	
Diamondback Terrapin	<i>Malaclemys terrapin</i>	N.C, EM		58	
Dinner-plate Tortoise	<i>Palea steindachneri</i>	N.C, TR		23	
Dominican Slider	<i>Trachemys stejnegeri vicina</i>	N.C, EM		56*	
Donner-weer Tortoise	<i>Homopus boulengeri</i>	C, TE		3	
Dotted African Soft-shell Turtle(s)	<i>Cycloderma Spp.</i>	N.C, TR	6		
Duncan Island Giant Tortoise	<i>Geochelone nigra ephippium</i>	C, TE		2*	
Duncan Island Tortoise	<i>Geochelone nigra ephippium</i>	C, TE		2*	
Dura Turtle	<i>Kachuga tecta</i>	C, EM		57	
Durango Mud Turtle	<i>Kinosternon flavescens durangoense</i>	N.C, KI		34*	
E					
East African Black Mud Turtle	<i>Pelusios subniger subniger</i>	C, PE-14		30*	1
East African Mud Turtle	<i>Pelusios subniger</i>	C, PE-14		30*	1
East African Serrated Mud Turtle	<i>Pelusios sinuatus</i>	N.C, PE-13		30*	1
East African Yellow-bellied Mud Turtle	<i>Pelusios castaneus</i>	C, PE-5		30	1
East African Yellow-bellied Mud Turtle	<i>Pelusios castanoides castanoides</i>	N.C, PE-6		30*	1
East Indian Box Turtle	<i>Cuora amboinensis amboinensis</i>	N.C, EM		42	
Eastern American Box Turtle	<i>Terrapene carolina</i>	C, EM		43	
Eastern Box Turtle	<i>Terrapene carolina</i>	C, EM		43	
Eastern Chicken Turtle	<i>Deirochelys reticularia reticularia</i>	N.C, EM		47	
Eastern Common Box Turtle	<i>Terrapene carolina carolina</i>	C, EM		43	
Eastern Hermann's Tortoise	<i>Testudo hermanni boettgeri</i>	C, TE		16*	
Eastern Hinge-back Turtle	<i>Kinixys belliana belliana</i>	C, TE	5		
Eastern Leopard Tortoise	<i>Geochelone pardalis babcocki</i>	C, TE		10*	

*符號表示物種或亞種在本圖鑑未說明

附錄B

英文名	學名	管制,科名	藍	黃	橘
Eastern Mud Turtle	<i>Kinosternon subrubrum subrubrum</i>	N.C, KI		35	
Eastern Painted Turtle	<i>Chrysemys picta picta</i>	N.C, EM		50	
Eastern Spiny Soft-shell	<i>Apalone spinifera spinifera</i>	N.C, TR		13	
Egyptian Tortoise	<i>Testudo kleinmanni</i>	C, TE		17	
Elongated Tortoise	<i>Indotestudo elongata</i>	C, TE		17	
Elseya novaeguineae	<i>Elseya novaeguineae</i>	N.C, CI		29	
Elseya Spp.	<i>Elseya Spp.</i>	N.C, CI		29	
Emydura Spp.	<i>Emydura Spp.</i>	N.C, CI		29	
Emydura subglobosa	<i>Emydura subglobosa</i>	N.C, CI		29	
Eretmochelys imbricata	<i>Eretmochelys imbricata</i>	C, CH	2		
Eroded Hinge-backed Turtle	<i>Kinixys erosa</i>	C, TE	5		
Erymnochelys madagascariensis	<i>Erymnochelys madagascariensis</i>	C, PE		31	
Euphrates Softshell Turtle	<i>Rafetus euphraticus</i>	N.C, TR		22	
European Pond Terrapin	<i>Emys orbicularis</i>	N.C, EM		45	
European Pond Turtle	<i>Emys orbicularis</i>	N.C, EM		45	
European Tortoise	<i>Testudo hermanni</i>	C, TE		16	
Eyed Terrapin(s)	<i>Morenia Spp.</i>	N.C-C, EM		58	
Eyed Turtle	<i>Sacalia bealei</i>	N.C, EM		57	
Eyed Turtle(s)	<i>Morenia Spp.</i>	N.C-C, EM		58	
Eyed Turtle(s)	<i>Sacalia Spp.</i>	N.C, EM		57	
F					
False Map Turtle	<i>Graptemys p. pseudogeographica</i>	N.C, EM		51	
Fernandina Island Giant Tortoise	<i>Geochelone nigra phantastica</i>	C, TE		2*	
Fitzsimmons' Turtle	<i>Pelusios bechuanicus</i>	N.C, PE-2		30*	1
Flap-shell Turtle	<i>Lissemys punctata</i>	C, TR	6		
Flapshell Turtle(s)	<i>Cyclanorbis Spp.</i>	N.C, TR	7		
Flapshell Turtle(s)	<i>Cycloderma Spp.</i>	N.C, TR	6		
Flat Backed Spider Tortoise	<i>Pyxis planicauda</i>	C, TE		18	
Flatback Spider Tortoise	<i>Pyxis planicauda</i>	C, TE		18	
Flatback Tortoise	<i>Geochelone platynota</i>	C, TE		5	
Flatback Turtle	<i>Chelonia agassizii</i>	C, CH	2		
Flatback Turtle	<i>Natator depressa</i>	C, CH	2		
Flatback Turtle(s)	<i>Chelonia Spp.</i>	C, CH	2		
Flat-backed Tortoise	<i>Geochelone platynota</i>	C, TE		5	
Flat-shelled Spider Tortoise	<i>Pyxis planicauda</i>	C, TE		18	
Flat-shelled Turtle	<i>Palea steindachneri</i>	N.C, TR		23	
Flat-shelled Turtle	<i>Platemys platycephala</i>	N.C, CI		27	
Florida Box Turtle	<i>Terrapene carolina bauri</i>	C, EM		43*	
Florida Chicken Turtle	<i>Deirochelys reticularia chrysea</i>	N.C, EM		47*	
Florida Cooter	<i>Pseudemys floridana</i>	N.C, EM		50	
Florida East Coast Diamondback Terrapin	<i>Malaclemys terrapin tequesta</i>	N.C, EM		58*	
Florida Gopher Tortoise	<i>Gopherus polyphemus</i>	C, TE		12	
Florida Mud Turtle	<i>Kinosternon subrubrum steindachneri</i>	N.C, KI		35*	
Florida Snapper	<i>Chelydra serpentina</i>	N.C, CY	8		
Florida Snapping Turtle	<i>Chelydra serpentina osceola</i>	N.C, CY	8*		
Florida Snapping Turtle	<i>Chelydra serpentina</i>	N.C, CY	8		
Florida Soft-shell Turtle	<i>Apalone ferox</i>	N.C, TR		24	
Florida Softshell Turtle	<i>Apalone ferox</i>	N.C, TR		24	
Flower Back Box Turtle	<i>Cuora galbinifrons</i>	N.C, EM		41	
Flower's Spur-thighed Tortoise	<i>Testudo graeca terrestris</i>	C, TE		16*	
Fly River Turtle	<i>Carettochelys insculpta</i>	N.C, CA	4		
Forest Hingeback Tortoise	<i>Kinixys erosa</i>	C, TE	5		
Forest Tortoise	<i>Geochelone denticulata</i>	C, TE		9	
Forest Turtle(s)	<i>Heosemys Spp.</i>	N.C, EM		53	
Forsten's Tortoise	<i>Indotestudo forstenii</i>	C, TE		10	
Four Toed Terrapin	<i>Batagur baska</i>	C, EM		47	
Four-eyed Turtle	<i>Sacalia quadriocellata</i>	N.C, EM		57	
Four-toed Tortoise	<i>Testudo horsfieldii</i>	C, TE		17	
Freshwater Turtle(s)	<i>Pseudemys Spp.,...</i>	N.C-C, EM		40 - 63	
Fuerte Slider	<i>Trachemys scripta hiltoni</i>	N.C, EM		52*	
G					
Gabon Terrapin	<i>Pelusios gabonensis</i>	C, PE-8		30*	1
Gabon Turtle	<i>Pelusios gabonensis</i>	C, PE-8		30*	1
Gaguama	<i>Lepidochelys kempii</i>	C, CH	3		
Galapago	<i>Kinosternon leucostomum</i>	N.C, KI		34	
Galapago	<i>Kinosternon scorpioides scorpioides</i>	N.C, KI		38	
Galapagos Giant Tortoise	<i>Geochelone nigra</i>	C, TE		2	
Galapagos Tortoise	<i>Geochelone nigra abingdonii</i>	C, TE		2*	

*符號表示物種或亞種在本圖鑑未說明

附錄B

英文名	學名	管制,科名	藍	黃	橘
Galapagos Tortoise	<i>Geochelone nigra</i>	C, TE		2	
Ganges Soft-shell Turtle	<i>Aspideretes gangeticus</i>	C, TR		21	
Geochelone carbonaria	<i>Geochelone carbonaria</i>	C, TE		9	
Geochelone chilensis	<i>Geochelone chilensis</i>	C, TE		11	
Geochelone denticulata	<i>Geochelone denticulata</i>	C, TE		9	
Geochelone elegans	<i>Geochelone elegans</i>	C, TE		5	
Geochelone gigantea	<i>Geochelone gigantea</i>	C, TE		2	
Geochelone nigra	<i>Geochelone nigra</i>	C, TE		2	
Geochelone pardalis	<i>Geochelone pardalis</i>	C, TE		10	
Geochelone platynota	<i>Geochelone platynota</i>	C, TE		5	
Geochelone radiata	<i>Geochelone radiata</i>	C, TE		5	
Geochelone Spp.	<i>Geochelone Spp.</i>	C, TE		2 - 20	
Geochelone sulcata	<i>Geochelone sulcata</i>	C, TE		10	
Geochelone yniphora	<i>Geochelone yniphora</i>	C, TE		13	
Geoclemys hamiltoni	<i>Geoclemys hamiltonii</i>	C, EM		60	
Geoclemys hamiltonii	<i>Geoclemys hamiltonii</i>	C, EM		60	
Geoemyda japonica	<i>Geoemyda spengleri japonica</i>	N.C, EM		60*	
Geoemyda spengleri	<i>Geoemyda spengleri</i>	N.C, EM		60	
Geoemyda Spp.	<i>Geoemyda Spp.</i>	N.C, EM		60	
Geometric Tortoise	<i>Psammobates geometricus</i>	C, TE		6	
Geometric Tortoise(s)	<i>Psammobates Spp.</i>	C, TE		6	
Giant Asian Pond Turtle	<i>Heosemys grandis</i>	N.C, EM		53	
Giant South American River Turtle	<i>Podocnemis expansa</i>	C, PE		32	
Gopher Tortoise	<i>Gopherus polyphemus</i>	C, TE		12	
Gopher Tortoise(s)	<i>Gopherus Spp.</i>	C, TE		12	
Gopher	<i>Gopherus berlandieri</i>	C, TE		12	
Gopherus agassizi	<i>Gopherus agassizi</i>	C, TE		12	
Gopherus agassizii	<i>Gopherus agassizii</i>	C, TE		12	
Gopherus berlandieri	<i>Gopherus berlandieri</i>	C, TE		12	
Gopherus flavomarginatus	<i>Gopherus flavomarginatus</i>	C, TE		19	
Gopherus polyphemus	<i>Gopherus polyphemus</i>	C, TE		12	
Gopherus Spp.	<i>Gopherus Spp.</i>	C, TE		12	
Graptemys geographica	<i>Graptemys geographica</i>	N.C, EM		51	
Graptemys oculifera	<i>Graptemys oculifera</i>	N.C, EM		51	
Graptemys pseudogeographica	<i>Graptemys pseudogeographica</i>	N.C, EM		51	
Graptemys Spp.	<i>Graptemys Spp.</i>	N.C, EM		51	
Gray's Slider	<i>Trachemys scripta grayi</i>	N.C, EM		52*	
Great Yellow Mexican Tortoise	<i>Gopherus flavomarginatus</i>	C, TE		19	
Greater Padloper	<i>Homopus femoralis</i>	C, TE		3	
Greek Tortoise	<i>Testudo graeca</i>	C, TE		16	
Greek Tortoise	<i>Testudo hermanni</i>	C, TE		16	
Green Turtle	<i>Chelonia mydas</i>	C, CH	2		
Green Turtle(s)	<i>Chelonia Spp.</i>	C, CH	2		
Griechische Landschildkröte	<i>Testudo hermanni</i>	C, TE		16	
Grooved Mountain Tortoise	<i>Homopus areolatus</i>	C, TE		14	
Grooved Tortoise	<i>Geochelone sulcata</i>	C, TE		10	
Guadalupe Spiny Softshell Turtle	<i>Apalone spinifera guadalupensis</i>	N.C, TR		13*	
Guadalupe Spiny Soft-shell	<i>Apalone spinifera</i>	N.C, TR		13	
Gulf Coast Box Turtle	<i>Terrapene carolina major</i>	C, EM		43*	
Gulf Coast Smooth Softshell Turtle	<i>Apalone mutica calvata</i>	N.C, TR		25*	
Gulf Coast Spiny Softshell	<i>Apalone spinifera aspera</i>	N.C, TR		13*	
Gulf Ridley Turtle	<i>Lepidochelys kempii</i>	C, CH	3		
Gulf Ridley	<i>Lepidochelys kempii</i>	C, CH	3		
H					
Hainan Box Turtle	<i>Cuora galbinifrons hainanensis</i>	N.C, EM		41*	
Hainan Serrated Box Turtle	<i>Cuora galbinifrons serrata</i>	N.C, EM		41*	
Haitian Slider	<i>Trachemys decorata</i>	N.C, EM		50	
Hard-shelled Terrapin	<i>Melanochelys trijuga</i>	N.C, EM		61	
Hawksbill Turtle	<i>Eretmochelys imbricata</i>	C, CH	2		
Hellenic Pond Turtle	<i>Emys orbicularis hellenica</i>	N.C, EM		45*	
Helmeted Terrapin	<i>Pelomedusa subrufa</i>	C, PE		30	
Helmeted Turtle	<i>Pelomedusa subrufa</i>	C, PE		30	
Heosemys grandis	<i>Heosemys grandis</i>	N.C, EM		53	
Heosemys spinosa	<i>Heosemys spinosa</i>	N.C, EM		53	
Heosemys Spp.	<i>Heosemys Spp.</i>	N.C, EM		53	
Hercules Tortoise	<i>Geochelone denticulata</i>	C, TE		9	
Hermann's Tortoise	<i>Testudo hermanni</i>	C, TE		16	
Hidden-neck Turtle(s)	<i>Pelusios Spp.</i>	N.C-C, PE		30 - 33	1

*符號表示物種或亞種在本圖鑑未說明

附錄B

英文名	學名	管制,科名	藍	黃	橘
Hieremys annandalei	Hieremys annandalii	N.C, EM		56	
Hieremys annandalii	Hieremys annandalii	N.C, EM		56	
Hinge-back Tortoise(s)	Kinixys Spp.	C, TE	5		
Hinge-backed Tortoise(s)	Kinixys Spp.	C, TE	5		
Hinged Tortoise(s)	Kinixys Spp.	C, TE	5		
Hispaniolan Elegant Slider	Trachemys decorata	N.C, EM		50	
Hispaniolan Slider	Trachemys decorata	N.C, EM		50	
Home's Hinge-back Tortoise	Kinixys homeana	C, TE	5		
Home's Hinged Tortoise	Kinixys homeana	C, TE	5		
Homopode(s)	Homopus Spp.	C, TE		3, 14, 18	
Homopus areolatus	Homopus areolatus	C, TE		14	
Homopus boulengeri	Homopus boulengeri	C, TE		3	
Homopus femoralis	Homopus femoralis	C, TE		3	
Homopus signatus	Homopus signatus	C, TE		18	
Homopus Spp.	Homopus Spp.	C, TE		3, 14, 18	
Hood Island Giant Tortoise	Geochelone nigra hoodensis	C, TE		2*	
Hood Island Tortoise	Geochelone nigra hoodensis	C, TE		2*	
Hooked Beaked Terrapin	Pelusios niger	C, PE-10		30*	1
Horsfield's Tortoise	Testudo horsfieldii	C, TE		17	
Huastecan Slider	Trachemys scripta cataspila	N.C, EM		52*	
Hydromedusa maximiliani	Hydromedusa maximiliani	N.C, CI		28	
Hydromedusa Spp.	Hydromedusa Spp.	N.C, CI		28	
Hydromedusa tectifera	Hydromedusa tectifera	N.C, CI		28	
I					
Iberian Tortoise	Testudo graeca	C, TE		16	
Iguana Cove Tortoise	Geochelone nigra vicina	C, TE		2*	
Illinois Mud Turtle	Kinosternon flavescens	N.C, KI		34	
Impressed Tortoise	Manouria impressa	C, TE		18	
Impression Tortoise	Manouria impressa	C, TE		18	
Inagua Slider	Trachemys stejnegeri malonei	N.C, EM		56*	
Indefatigable Island Giant Tortoise	Geochelone nigra nigrita	C, TE		2*	
Indefatigable Island Tortoise	Geochelone nigra nigrita	C, TE		2*	
Indian Black Turtle	Melanochelys trijuga	N.C, EM		61	
Indian Black Turtle(s)	Melanochelys Spp.	N.C-C, EM		61	
Indian Cyclanorbine	Lissemys punctata	C, TR	6		
Indian Eyed Turtle	Morenia petersi	N.C, EM		58	
Indian Flapshell Turtle	Lissemys punctata punctata	C, TR	6		
Indian Flapshell Turtle(s)	Lissemys Spp.	N.C-C, TR	6		
Indian Ocean Giant Tortoise	Geochelone gigantea	C, TE		2	
Indian Peacock Soft-shell Turtle	Aspideretes hurum	C, TR		21	
Indian Pond Turtle	Kachuga tecta	C, EM		57	
Indian Roofed Turtle	Kachuga tecta	C, EM		57	
Indian Roofed Turtle(s)	Kachuga Spp.	N.C-C, EM		57	
Indian Sawback Turtle	Kachuga tecta	C, EM		57	
Indian Softshell Turtle	Aspideretes gangeticus	C, TR		21	
Indian Softshell Turtle(s)	Aspideretes Spp.	N.C-C, TR		21, 22	
Indian Soft-shelled Turtle	Lissemys punctata	C, TR	6		
Indian Star Tortoise	Geochelone elegans	C, TE		5	
Indian Starred Tortoise	Geochelone elegans	C, TE		5	
Indian Tent Turtle	Kachuga tecta	C, EM		57	
Indian Tent Turtle	Kachuga tentoria tentoria	N.C, EM		57	
Indochinese Box Turtle	Cuora galbinifrons	N.C, EM		41	
Indochinese Tortoise(s)	Manouria Spp.	C, TE		13, 18	
Indo-Gangetic Flapshell Turtle	Lissemys punctata andersoni	C, TR	6*		
Indo-Gangetic Flap-shell	Lissemys punctata andersoni	C, TR	6*		
Indonesian Box Turtle	Cuora amboinensis	N.C, EM		42	
Indonesian Tortoise	Indotestudo forstenii	C, TE		10	
Indotestudo elongata	Indotestudo elongata	C, TE		17	
Indotestudo forstenii	Indotestudo forstenii	C, TE		10	
Indotestudo Spp.	Indotestudo Spp.	C, TE		10, 17	
Iranian Spur-thighed Tortoise	Testudo graeca zarudnyi	C, TE		16*	
J					
Jaboty Tortoise	Geochelone denticulata	C, TE		9	
Jagged-shell Turtle	Pyxidea mouhotii	N.C, EM		40	
Jamaican Slider	Trachemys terrapen	N.C, EM		52	
James Island Tortoise	Geochelone nigra darwini	C, TE		2*	
James Island Giant Tortoise	Geochelone nigra darwini	C, TE		2*	
K					
Kachuga Spp.	Kachuga Spp.	N.C-C, EM		57	

*符號表示物種或亞種在本圖鑑未說明

附錄B

英文名	學名	管制,科名	藍	黃	橘
Kachuga tecta	Kachuga tecta	C, EM		57	
Kachuga tentoria	Kachuga tentoria	N.C, EM		57	
Kachuga trivittata	Kachuga trivittata	N.C, EM		57	
Kachuga(s)	Kachuga Spp.	N.C-C, EM		57	
Karoo Cape Tortoise	Homopus femoralis	C, TE		3	
Karoo Tortoise	Homopus femoralis	C, TE		3	
Kazakhstan Tortoise	Testudo horsfieldii kazachstanica	C, TE		17*	
Keel-backed Musk Turtle	Kinosternon carinatum	N.C, KI		36	
Keelbacked Terrapin	Pyxidea mouhotii	N.C, EM		40	
Keeled Box Turtle	Pyxidea mouhotii	N.C, EM		40	
Keeled-back Musk Turtle	Kinosternon carinatum	N.C, KI		36	
Kemp's Ridley Turtle	Lepidochelys kempii	C, CH	3		
Khasi Hill Tortoise	Cyclemys dentata	N.C, EM		40	
Kinixys belliana	Kinixys belliana	C, TE	5		
Kinixys erosa	Kinixys erosa	C, TE	5		
Kinixys homeana	Kinixys homeana	C, TE	5		
Kinixys natalensis	Kinixys natalensis	C, TE	5		
Kinixys Spp.	Kinixys Spp.	C, TE	5		
Kinosternon acutum	Kinosternon acutum	N.C, KI		37	
Kinosternon bauri	Kinosternon baurii	N.C, KI		34	
Kinosternon baurii	Kinosternon baurii	N.C, KI		34	
Kinosternon carinatum	Kinosternon carinatum	N.C, KI		36	
Kinosternon flavescens	Kinosternon flavescens	N.C, KI		34	
Kinosternon leucostomum	Kinosternon leucostomum	N.C, KI		34	
Kinosternon scorpioides cruentatum	Kinosternon scorpioides cruentatum	N.C, KI		38	
Kinosternon scorpioides scorpioides	Kinosternon scorpioides scorpioides	N.C, KI		38	
Kinosternon subrubrum	Kinosternon subrubrum	N.C, KI		35	
Kleinmann's Tortoise	Testudo kleinmanni	C, TE		17	
Knobby Geometric Tortoise	Psammobates tentorius	C, TE		6	
Kopet-Dag Tortoise	Testudo horsfieldii rustamovi	C, TE		17*	
Kuhl's Tortoise	Psammobates oculiferus	C, TE		6	
L					
Lake Albert Mud Turtle	Pelusios williamsi lutescens	N.C, PE-16		30*	1
Lake Turkana Mud Turtle	Pelusios broadleyi	N.C, PE-3		30*	1
Lake Victoria Mud Turtle	Pelusios williamsi williamsi	N.C, PE-16		30*	1
Land-dwelling Turtle(s)	Testudo Spp.	C, TE	5	2 - 20	
Leaf Turtle	Cyclemys dentata	N.C, EM		40	
Leaf Turtle(s)	Cyclemys Spp.	N.C, EM		40, 54	
Leaf Turtle(s)	Geoemyda Spp.	N.C, EM		60	
Leatherback Turtle	Dermochelys coriacea	C, DO	4		
Leatherback	Dermochelys coriacea	C, DO	4		
Leathery Turtle	Dermochelys coriacea	C, DO	4		
Leith's Softshell Turtle	Aspideretes leithii	N.C, TR		21	
Leith's Tortoise	Testudo kleinmanni	C, TE		17	
Leopard Tortoise	Geochelone pardalis	C, TE		10	
Lepidochelys kempii	Lepidochelys kempii	C, CH	3		
Lepidochelys olivacea	Lepidochelys olivacea	C, CH	3		
Lepidochelys Spp.	Lepidochelys Spp.	C, CH	3		
Lissemys punctata	Lissemys punctata	C, TR	6		
Lissemys Spp.	Lissemys Spp.	N.C-C, TR	6		
Llanos Sideneck Turtle	Podocnemis vogli	C, PE		32	
Lobatse Hinge-back Turtle	Kinixys belliana lobatsiana	C, TE	5*		
Loggerhead Musk Turtle	Sternotherus minor minor	N.C, KI		36	
Loggerhead Turtle	Caretta caretta	C, CH	3		
M					
Macroclemys temminckii	Macroclemys temminckii	N.C, CY	8		
Madagascan Big-headed Side-necked Turtle	Erymnochelys madagascariensis	C, PE		31	
Madagascan Big-headed Turtle	Erymnochelys madagascariensis	C, PE		31	
Madagascan Flat-tailed Tortoise	Pyxis planicauda	C, TE		18	
Madagascan Spider Tortoise	Pyxis arachnoides	C, TE		7	
Madagascan Tortoise	Geochelone yniphora	C, TE		13	
Madagascar Angulated Tortoise	Geochelone yniphora	C, TE		13	
Madagascar Big Headed Turtle	Erymnochelys madagascariensis	C, PE		31	
Madagascar Flat-shelled Tortoise	Pyxis planicauda	C, TE		18	
Madagascar Sideneck Turtle	Erymnochelys madagascariensis	C, PE		31	
Madagascar Spurred Tortoise	Geochelone yniphora	C, TE		13	
Madagascar Tortoise(s)	Geochelone Spp.	C, TE		5, 13	
Magdalena River Turtle	Podocnemis lewyana	C, PE		32	
Magrab Pond Turtle	Emys orbicularis occidentalis	N.C, EM		45*	

*符號表示物種或亞種在本圖鑑未說明

附錄B

英文名	學名	管制,科名	藍	黃	橘
Malaclemys terrapin	Malaclemys terrapin	N.C, EM		58	
Malacochersus tornieri	Malacochersus tornieri	C, TE		7	
Malayan Box Turtle	Cuora amboinensis	N.C, EM		42	
Malayan Flat-shelled Turtle	Notochelys platynota	N.C, EM		40	
Malayan Snail-eating Turtle	Malayemys subtrijuga	N.C, EM		62	
Malayan Softshell Turtle	Dogania subplana	N.C, TR		24	
Malayemys subtrijuga	Malayemys subtrijuga	N.C, EM		62	
Malaysian Giant Turtle	Orlitia borneensis	N.C, EM		47	
Mangrove Diamondback Terrapin	Malaclemys terrapin rhizophorarum	N.C, EM		58*	
Manouria emys	Manouria emys	C, TE		13	
Manouria impressa	Manouria impressa	C, TE		18	
Manouria Spp.	Manouria Spp.	C, TE		13, 18	
Map Turtle	Graptemys geographica	N.C, EM		51	
Map Turtle(s)	Graptemys Spp.	N.C, EM		51	
Marginated Tortoise	Testudo marginata	C, TE		14	
Margined Tortoise	Testudo marginata	C, TE		14	
Marine Turtle(s)	Caretta Sp.,....	C, CH	2, 3		
Marsh Terrapin	Pelomedusa subrufa	C, PE		30	
Marsh Turtle(s)	Pseudemys Spp.,....	N.C-C, EM		40 - 63	
Matamata Turtle	Chelus fimbriata	N.C, CI		29	
Maximilian's Snake-headed Turtle	Hydromedusa maximiliani	N.C, CI		28	
Mediterranean Spur-thighed Tortoise	Testudo graeca graeca	C, TE		16	
Mediterranean Tortoise	Testudo hermanni	C, TE		16	
Melanochelys Spp.	Melanochelys Spp.	N.C-C, EM		61	
Melanochelys tricarinata	Melanochelys tricarinata	C, EM		61	
Melanochelys trijuga	Melanochelys trijuga	N.C, EM		61	
Meso-American Slider	Trachemys scripta venusta	N.C, EM		52*	
Mesopotamian Soft-shelled Turtle	Rafetus euphraticus	N.C, TR		22	
Mexican Black Soft-shell	Apalone spinifera ater	C, TR		24	
Mexican Box Turtle	Terrapene carolina mexicana	C, EM		43*	
Mexican Giant Gopher	Gopherus flavomarginatus	C, TE		19	
Mexican Giant Tortoise	Gopherus flavomarginatus	C, TE		19	
Mexican Gopher Tortoise	Gopherus flavomarginatus	C, TE		19	
Mexican Ridley	Lepidochelys kempii	C, CH	3		
Middle East Spur-thighed Tortoise	Testudo graeca terrestris	C, TE		16*	
Midland Painted Turtle	Chrysemys picta marginata	N.C, EM		50*	
Midland Smooth Softshell Turtle	Apalone mutica mutica	N.C, TR		25	
Mississippi Diamondback Terrapin	Malaclemys terrapin pileata	N.C, EM		58*	
Mississippi Map Turtle	Graptemys pseudogeographica kohnii	N.C, EM		51	
Mississippi Mud Turtle	Kinosternon subrubrum hippocrepis	N.C, KI		35*	
Mississippi Mud Turtle	Kinosternon subrubrum	N.C, KI		35	
Mississippi Must Turtle	Kinosternon carinatum	N.C, KI		36	
Mississippi Sawback Turtle	Graptemys pseudogeographica kohnii	N.C, EM		51	
Missouri-Slider	Pseudemys floridana	N.C, EM		50	
Mobile Turtle	Pseudemys floridana	N.C, EM		50	
Moorish Tortoise	Testudo graeca	C, TE		16	
Morenia ocellata	Morenia ocellata	C, EM		58	
Morenia petersi	Morenia petersi	N.C, EM		58	
Morenia Spp.	Morenia Spp.	N.C-C, EM		58	
Mountain Tortoise	Geochelone pardalis	C, TE		10	
Mud Turtle(s)	Kinosternon Spp.,....	N.C, KI		34 - 38	
Mud Turtle(s)	Pelusios Spp.	N.C-C, PE		30	
Muhlenberg's Turtle	Clemmys muhlenbergii	C, EM		49	
Musk Turtle	Sternotherus odoratus	N.C, KI		35	
Musk Turtle(s)	Kinosternon Spp.,....	N.C, KI		34 - 38	
Musk Turtle(s)	Sternotherus Spp.	N.C, KI		35, 36	
N					
Narborough Island Tortoise	Geochelone nigra phantastica	C, TE		2*	
Narrow-headed Soft-shell Turtle	Chitra indica	N.C, TR		25	
Natal Hinge-back Tortoise	Kinixys natalensis	C, TE	5		
Natal Hinged Tortoise	Kinixys natalensis	C, TE	5		
Nayarit Box Turtle	Terrapene nelsoni	C, EM		44	
Nazas Slider	Trachemys scripta hartwegi	N.C, EM		52*	
Nelson's Box Turtle	Terrapene nelsoni	C, EM		44	
New Guinea Plateless Turtle	Carettochelys insculpta	N.C, CA	4		
New Guinea Snapping Turtle	Elseya novaeguineae	N.C, CI		29	
Nicaraguan Slider	Trachemys scripta emolli	N.C, EM		52*	
Nicaraguan Slider	Trachemys scripta	N.C, EM		52	
Nikolsky's Spur-thighed Tortoise	Testudo graeca nikolskii	C, TE		16*	

*符號表示物種或亞種在本圖鑑未說明

附錄B

英文名	學名	管制,科名	藍	黃	橘
Nile Soft-shell Turtle	<i>Trionyx triunguis</i>	C, TR		23	
Nilssonina formosa	<i>Nilssonina formosa</i>	N.C, TR		21, 23	
Nilssonina formosus	<i>Nilssonina formosa</i>	N.C, TR		21, 23	
North African Helmeted Turtle	<i>Pelomedusa subrufa olivacea</i>	C, PE		30*	
North American Softshell Turtle(s)	<i>Apalone Spp.</i>	N.C-C, TR		24, 25	
North American Wood Turtle	<i>Clemmys insculpta</i>	C, EM		54	
Northern Diamondback Turtle	<i>Malaclemys terrapin terrapin</i>	N.C, EM		58	
Northern Pacific Pond Turtle	<i>Clemmys marmorata marmorata</i>	N.C, EM		49	
Northern Speckled Cape Tortoise	<i>Homopus signatus signatus</i>	C, TE		18	
Northern Spider Tortoise	<i>Pyxis arachnoides brygooi</i>	C, TE		7*	
Northern Spotted Box Turtle	<i>Terrapene nelsoni klauberi</i>	C, EM		44*	
Northern Tent Tortoise	<i>Psammobates tentorius verroxii</i>	C, TE		6*	
Northern White-lipped Mud Turtle	<i>Kinosternon leucostomum leucostomum</i>	N.C, KI		34	
Notochelys platynota	<i>Notochelys platynota</i>	N.C, EM		40	
Nubian Flapshell Turtle	<i>Cyclanorbis elegans</i>	N.C, TR	7		
Nubian Soft-shell Turtle	<i>Cyclanorbis elegans</i>	N.C, TR	7		
O					
Obst Pond Turtle	<i>Emys orbicularis fritzjuergenobsti</i>	N.C, EM		45*	
Ocadia sinensis	<i>Ocadia sinensis</i>	N.C, EM		48	
Ocadia Spp.	<i>Ocadia Spp.</i>	N.C, EM		48	
Ocellated Peacock Turtle	<i>Morenia ocellata</i>	C, EM		58	
Okavango Mud Turtle	<i>Pelusios bechuanicus</i>	N.C, PE-2		30*	1
Okinawa Black-breasted Leaf Turtle	<i>Geoemyda spengleri japonica</i>	N.C, EM		60*	
Olive Ridley Turtle	<i>Lepidochelys olivacea</i>	C, CH	3		
Orinoco Turtle	<i>Podocnemis vogli</i>	C, PE		32	
Orlitia borneensis	<i>Orlitia borneensis</i>	N.C, EM		47	
Ornate Box Turtle	<i>Terrapene ornata ornata</i>	C, EM		44	
Ornate Diamondback Terrapin	<i>Malaclemys terrapin macrospilota</i>	N.C, EM		58*	
Ornate Diamondback Terrapin	<i>Malaclemys terrapin</i>	N.C, EM		58	
Ornate Slider	<i>Trachemys scripta ornata</i>	N.C, EM		52*	
Ornate Slider	<i>Trachemys scripta</i>	N.C, EM		52	
P					
Pacific Green Turtle	<i>Chelonia agassizii</i>	C, CH	2		
Pacific Hawksbill Turtle	<i>Eretmochelys imbricata bissa</i>	C, CH	2*		
Pacific Pond Turtle	<i>Clemmys marmorata</i>	N.C, EM		49	
Pacific Ridley	<i>Lepidochelys olivacea</i>	C, CH	3		
Painted Terrapin	<i>Callagur borneoensis</i>	N.C, EM		48	
Painted Turtle	<i>Chrysemys picta</i>	N.C, EM		50	
Palea steindachneri	<i>Palea steindachneri</i>	N.C, TR		23	
Palaearctic Tortoise(s)	<i>Testudo Spp.</i>	C, TE		14 - 17	
Pallid Spiny Softshell Turtle	<i>Apalone spinifera pallida</i>	N.C, TR		13*	
Pancake Tortoise	<i>Malacochersus tornieri</i>	C, TE		7	
Parker's Black Turtle	<i>Melanochelys trijuga parkeri</i>	N.C, EM		61*	
Parrot-beaked Tortoise	<i>Homopus areolatus</i>	C, TE		14	
Pastel Red Ear Slider	<i>Trachemys scripta</i>	N.C, EM		52	
Peacock Soft-shell Turtle	<i>Aspideretes hurum</i>	C, TR		21	
Peacock Turtle	<i>Morenia ocellata</i>	C, EM		58	
Peacock Turtle(s)	<i>Morenia Spp.</i>	N.C-C, EM		58	
Peacock-marked Soft-shell Turtle	<i>Aspideretes hurum</i>	C, TR		21	
Pelochelys bibroni	<i>Pelochelys bibroni</i>	N.C, TR		25	
Pelodiscus sinensis	<i>Pelodiscus sinensis</i>	N.C, TR		22	
Pelomedusa subrufa	<i>Pelomedusa subrufa</i>	C, PE		30	
Pelomedusid Turtle(s)	<i>Pelusios Spp.</i>	N.C-C, PE		30	1
Peltocephalus dumeriliana	<i>Peltocephalus dumerilianus</i>	C, PE		31	
Peltocephalus dumerilianus	<i>Peltocephalus dumerilianus</i>	C, PE		31	
Pelusios adansonii	<i>Pelusios adansonii</i>	C, PE-1		30*	1
Pelusios bechuanicus	<i>Pelusios bechuanicus</i>	N.C, PE-2		30*	1
Pelusios broadleyi	<i>Pelusios broadleyi</i>	N.C, PE-3		30*	1
Pelusios carinatus	<i>Pelusios carinatus</i>	N.C, PE-4		30*	1
Pelusios castaneus	<i>Pelusios castaneus</i>	C, PE-5		30	1
Pelusios castanoides	<i>Pelusios castanoides</i>	N.C, PE-6		30*	1
Pelusios chapini	<i>Pelusios chapini</i>	N.C, PE-7		30*	1
Pelusios gabonensis	<i>Pelusios gabonensis</i>	C, PE-8		30*	1
Pelusios nanus	<i>Pelusios nanus</i>	N.C, PE-9		30*	1
Pelusios niger	<i>Pelusios niger</i>	C, PE-10		30*	1
Pelusios seychellensis	<i>Pelusios seychellensis</i>	N.C, PE-12		30*	1
Pelusios sinuatus	<i>Pelusios sinuatus</i>	N.C, PE-13		30*	1

*符號表示物種或亞種在本圖鑑未說明

附錄B

英文名	學名	管制,科名	藍	黃	橘
Pelusios Spp.	Pelusios Spp.	N.C-C, PE		30	1
Pelusios subniger	Pelusios subniger	C, PE-14		30*	1
Pelusios upembae	Pelusios upembae	N.C, PE-15		30*	1
Pelusios williamsi	Pelusios williamsi	N.C, PE-16		30*	1
Peninsula Cooter	Pseudemys floridana peninsularis	N.C, EM		50*	
Peninsular Black Turtle	Melanochelys trijuga trijuga	N.C, EM		61	
Pentonyx gabonensis	Pelusios gabonensis	C, PE-8		30*	1
Peter's Peacock Turtle	Morenia petersi	N.C, EM		58	
Pig-nose Turtle	Carettochelys insculpta	N.C, CA	4		
Pineapple Tortoise	Indotestudo elongata	C, TE		17	
Pink-ringed Tent Turtle	Kachuga tentoria circumdata	N.C, EM		57*	
Pink-ringed Tent Turtle	Kachuga tentoria	N.C, EM		57	
Pitted-shell Turtle	Carettochelys insculpta	N.C, CA	4		
Plateless Turtle	Carettochelys insculpta	N.C, CA	4		
Platemys platycephala	Platemys platycephala	N.C, CI		27	
Platysternon megacephalum	Platysternon megacephalum	N.C, PT	9		
Ploughshare Tortoise	Geochelone yniphora	C, TE		13	
Podocnemis dumeriliana	Peltocephalus dumerilianus	C, PE		31	
Podocnemis erythrocephala	Podocnemis erythrocephala	C, PE		33	
Podocnemis expansa	Podocnemis expansa	C, PE		32	
Podocnemis lewyana	Podocnemis lewyana	C, PE		32	
Podocnemis madagascariensis	Erymnochelys madagascariensis	C, PE		31	
Podocnemis sextuberculata	Podocnemis sextuberculata	C, PE		33	
Podocnemis Spp.	Podocnemis Spp.	C, PE		32, 33	
Podocnemis unifilis	Podocnemis unifilis	C, PE		33	
Podocnemis vogli	Podocnemis vogli	C, PE		32	
Pond Turtle	Clemmys marmorata	N.C, EM		49	
Pond Turtle(s)	Clemmys Spp.	N.C-C, EM		49, 54	
Pond Turtle(s)	Pseudemys Spp.,....	N.C-C, EM		40 - 63	
Prince Maximilians Turtle	Hydromedusa maximiliani	N.C, CI		28	
Psammobate geometrico	Psammobates geometricus	C, TE		6	
Psammobates geometricus	Psammobates geometricus	C, TE		6	
Psammobates oculiferus	Psammobates oculiferus	C, TE		6	
Psammobates Spp.	Psammobates Spp.	C, TE		6	
Psammobates tentorius	Psammobates tentorius	C, TE		6	
Pseudemys umbrina	Pseudemys umbrina	C, CI		27	
Pseudemys floridana	Pseudemys floridana	N.C, EM		50	
Pseudemys rubriventris	Pseudemys rubriventris	N.C, EM		46	
Pseudemys Spp.	Pseudemys Spp.	N.C, EM		46, 50	
Puerto Rican Slider	Trachemys stejnegeri stejnegeri	N.C, EM		56	
Purple-bellied Terrapin	Notochelys platynota	N.C, EM		40	
Pyxidea mouhoti	Pyxidea mouhotii	N.C, EM		40	
Pyxidea mouhotii	Pyxidea mouhotii	N.C, EM		40	
Pyxis arachnoides	Pyxis arachnoides	C, TE		7	
Pyxis planicauda	Pyxis planicauda	C, TE		18	
Pyxis Spp.	Pyxis Spp.	C, TE		7, 18	
R					
Radiated Tortoise	Geochelone radiata	C, TE		5	
Rafetus euphraticus	Rafetus euphraticus	N.C, TR		22	
Rafetus Spp.	Rafetus Spp.	N.C, TR		22	
Ranong River Terrapin	Batagur baska ranongensis	C, EM		47*	
Razorback Musk Turtle	Kinosternon carinatum	N.C, KI		36	
Razor-backed Musk Turtle	Kinosternon carinatum	N.C, KI		36	
Red Ear Slider	Trachemys scripta	N.C, EM		52	
Red Foot Tortoise	Geochelone carbonaria	C, TE		9	
Red-bellied Short-necked Turtle	Emydura subglobosa	N.C, CI		29	
Red-bellied Turtle	Pseudemys rubriventris	N.C, EM		46	
Redbelly Turtle	Pseudemys rubriventris	N.C, EM		46	
Red-checked Mud Turtle	Kinosternon scorpioides cruentatum	N.C, KI		38	
Red-eared Slider	Trachemys scripta elegans	N.C, EM		52*	
Red-eared Turtle	Trachemys scripta	N.C, EM		52	
Red-footed Tortoise	Geochelone carbonaria	C, TE		9	
Red-headed Amazon River Turtle	Podocnemis erythrocephala	C, PE		33	
Red-headed Amazon River Turtle	Podocnemis erythrocephala	C, PE		33	
Red-headed Amazon Side-necked Turtle	Podocnemis erythrocephala	C, PE		33	
Red-headed Amazon Turtle	Podocnemis erythrocephala	C, PE		33	
Red-headed River Turtle	Podocnemis erythrocephala	C, PE		33	
Red-headed Sideneck	Podocnemis erythrocephala	C, PE		33	
Red-legged Tortoise	Geochelone carbonaria	C, TE		9	

*符號表示物種或亞種在本圖鑑未說明

附錄B

英文名	學名	管制,科名	藍	黃	橘
Red-necked Mud Turtle	<i>Kinosternon scorpioides cruentatum</i>	N.C, KI		38	
Red-necked Pond Turtle	<i>Chinemys nigricans</i>	N.C, EM		60	
Red-nosed Tortoise	<i>Indotestudo elongata</i>	C, TE		17	
Reeve's Turtle	<i>Chinemys reevesii</i>	N.C, EM		62	
Ridley Turtle(s)	<i>Lepidochelys Spp.</i>	C, CH	3		
Ridley(s)	<i>Lepidochelys Spp.</i>	C, CH	3		
Ringed Map Turtle	<i>Graptemys oculifera</i>	N.C, EM		51	
Ringed Sawback	<i>Graptemys oculifera</i>	N.C, EM		51	
Rio Magdalena River Turtle	<i>Podocnemis lewyana</i>	C, PE		32	
River Soft-shell	<i>Chitra indica</i>	N.C, TR		25	
River Terecay	<i>Podocnemis unifilis</i>	C, PE		33	
River Terrapin	<i>Batagur baska</i>	C, EM		47	
River Turtle	<i>Dermatemys mawii</i>	C, DE		39	
River Turtle(s)	<i>Pelusios Spp.</i>	N.C-C, PE		30 - 33	1
Robert Mertens Tortoise	<i>Testudo horsfieldii</i>	C, TE		17	
Roofed Turtle	<i>Kachuga tecta</i>	C, EM		57	
Roofed Turtle(s)	<i>Kachuga Spp.</i>	N.C-C, EM		57	
Russian Tortoise	<i>Testudo horsfieldii</i>	C, TE		17	
Ryukyu Yellow-margined Box Turtle	<i>Cuora flavomarginata evelynae</i>	N.C, EM		42*	
S					
Sabanera	<i>Podocnemis vogli</i>	C, PE		32	
Sacalia bealei	<i>Sacalia bealei</i>	N.C, EM		57	
Sacalia quadriocellata	<i>Sacalia quadriocellata</i>	N.C, EM		57	
Sacalia Spp.	<i>Sacalia Spp.</i>	N.C, EM		57	
Sacred Black Mud Turtle	<i>Aspideretes nigricans</i>	C, TR		22	
Sahelian Terrapin	<i>Pelusios adansonii</i>	C, PE-1		30*	1
Savanna Side-necked Turtle	<i>Podocnemis vogli</i>	C, PE		32	
Schweigger's Hinge-back Tortoise	<i>Kinixys erosa</i>	C, TE	5		
Schweigger's Hinged Tortoise	<i>Kinixys erosa</i>	C, TE	5		
Schweiggers Terrapin	<i>Pelusios castaneus</i>	C, PE-5		30	1
Scorpion Mud Turtle	<i>Kinosternon scorpioides cruentatum</i>	N.C, KI		38	
Scorpion Mud Turtle	<i>Kinosternon scorpioides scorpioides</i>	N.C, KI		38	
Sea Turtle(s)	<i>Caretta Sp.</i>	C, CH	2, 3		
Senegal Flapshell Turtle	<i>Cyclanorbis senegalensis</i>	N.C, TR	7		
Senegal Soft-shell Turtle	<i>Cyclanorbis senegalensis</i>	N.C, TR	7		
Serrated Geometric Tortoise	<i>Psammobates oculiferus</i>	C, TE		6	
Serrated Hinge-back Tortoise	<i>Kinixys erosa</i>	C, TE	5		
Serrated Hinge-back Turtle	<i>Kinixys erosa</i>	C, TE	5		
Serrated Hinged Tortoise	<i>Kinixys erosa</i>	C, TE	5		
Serrated Mud Turtle	<i>Pelusios sinuatus</i>	N.C, PE-13		30*	1
Serrated Star Tortoise	<i>Psammobates oculiferus</i>	C, TE		6	
Serrated Terrapin	<i>Pelusios sinuatus</i>	N.C, PE-13		30*	1
Serrated Tortoise	<i>Psammobates oculiferus</i>	C, TE		6	
Serrated Turtle	<i>Pelusios sinuatus</i>	N.C, PE-13		30*	1
Seychelles Black Mud Turtle	<i>Pelusios subniger parietalis</i>	C, PE-14		30*	1
Seychelles Black Terrapin	<i>Pelusios seychellensis</i>	N.C, PE-12		30*	1
Seychelles Giant Tortoise	<i>Geochelone gigantea</i>	C, TE		2	
Seychelles Mud Turtle	<i>Pelusios seychellensis</i>	N.C, PE-12		30*	1
Seychelles Yellow-bellied Mud Turtle	<i>Pelusios castanoides intergularis</i>	N.C, PE-6		30*	1
Sharp-nosed Mud Turtle	<i>Kinosternon acutum</i>	N.C, KI		37	
Short-necked Turtle(s)	<i>Emydura Spp.</i>	N.C, CI		29	
Siamese Temple Turtle	<i>Siebenrockiella crassicolis</i>	N.C, EM		54	
Side-neck Turtle(s)	<i>Pelusios Spp.</i>	N.C-C, PE		30	1
Side-neck Turtle(s)	<i>Podocnemis Spp.</i>	C, PE		32, 33	
Side-necked Turtle	<i>Podocnemis erythrocephala</i>	C, PE		33	
Side-necked Turtle	<i>Podocnemis unifilis</i>	C, PE		33	
Side-necked Turtle(s)	<i>Acanthochelys Spp.</i>	N.C-C, CI		26 - 29	
Side-necked Turtle(s)	<i>Pelusios Spp.</i>	N.C-C, PE		30 - 33	1
Siebenrockiella crassicolis	<i>Siebenrockiella crassicolis</i>	N.C, EM		54	
Sierra Negra Giant Tortoise	<i>Geochelone nigra guntheri</i>	C, TE		2*	
Sierra Negra Tortoise	<i>Geochelone nigra guntheri</i>	C, TE		2*	
Six-footed Turtle	<i>Manouria emys</i>	C, TE		13	
Six-legged Tortoise	<i>Manouria emys</i>	C, TE		13	
Six-tubercled Amazon River Turtle	<i>Podocnemis sextuberculata</i>	C, PE		33	
Six-tubercled Amazonian Side-neck	<i>Podocnemis sextuberculata</i>	C, PE		33	
Six-tubercled River Turtle	<i>Podocnemis sextuberculata</i>	C, PE		33	
Skillpot Turtle	<i>Sternotherus odoratus</i>	N.C, KI		35	

*符號表示物種或亞種在本圖鑑未說明

附錄B

英文名	學名	管制,科名	藍	黃	橘
Slider Turtle	<i>Trachemys scripta</i>	N.C, EM		52	
Slider Turtle(s)	<i>Trachemys</i> Spp.	N.C, EM		50, 52, 56	
Slider(s)	<i>Pseudemys</i> Spp.	N.C, EM		46, 50	
Smooth Softshell Turtle	<i>Apalone mutica</i>	N.C, TR		25	
Snail-eating Turtle	<i>Malayemys subtrijuga</i>	N.C, EM		62	
Snake-eating Turtle	<i>Cuora flavomarginata</i>	N.C, EM		42	
Snake-neck Turtle(s)	<i>Hydromedusa</i> Spp.	N.C, CI		28	
Snake-necked Turtle(s)	<i>Acanthochelys</i> Spp.	N.C-C, CI		26 - 29	
Snapper(s)	<i>Elseya</i> spp.	N.C, CI		29	
Snapping Turtle	<i>Chelydra serpentina</i>	N.C, CY	8		
Snapping Turtle(s)	<i>Chelydra</i> Sp.	N.C, CY	8		
Snapping Turtle(s)	<i>Elseya</i> spp.	N.C, CI		29	
Softshell Turtle(s)	<i>Trionyx</i> Spp.	N.C-C, TR	6, 7	21 - 25	
Soft-shelled Tortoise	<i>Malacochersus tornieri</i>	C, TE		7	
Soft-shelled Turtle(s)	<i>Trionyx</i> Spp.	N.C-C, TR	6, 7	21 - 25	
South African Bowsprit Tortoise	<i>Chersina angulata</i>	C, TE		19	
South African Hinge-backed Tortoise	<i>Kinixys belliana</i>	C, TE	5		
South African Star Tortoise(s)	<i>Psammobates</i> Spp.	C, TE		6	
South African Starred Tortoise(s)	<i>Psammobates</i> Spp.	C, TE		6	
South African Tent Tortoise	<i>Psammobates tentorius</i>	C, TE		6	
South American Forest Tortoise	<i>Geochelone denticulata</i>	C, TE		9	
South American River Turtle	<i>Podocnemis expansa</i>	C, PE		32	
South American River Turtle	<i>Podocnemis unifilis</i>	C, PE		33	
South American River Turtle(s)	<i>Podocnemis</i> Spp.	C, PE		32, 33	
South American Side-necked Swamp Turtle(s)	<i>Acanthochelys</i> Spp.	N.C, CI		26	
South American Side-necked River Turtle(s)	<i>Podocnemis</i> Spp.	C, PE		32, 33	
South American Side-necked Turtle(s)	<i>Acanthochelys</i> Spp.	N.C, CI		26	
South American Side-necked	<i>Podocnemis</i> Spp.	C, PE		32, 33	
South American Snake-headed Turtle	<i>Hydromedusa tectifera</i>	N.C, CI		28	
South American Snake-necked Turtle	<i>Hydromedusa tectifera</i>	N.C, CI		28	
South American Snapping Turtle	<i>Chelydra serpentina acutirostris</i>	N.C, CY	8*		
South American Tortoise	<i>Geochelone denticulata</i>	C, TE		9	
South American Yellow-footed Tortoise	<i>Geochelone denticulata</i>	C, TE		9	
South-American Snake-neck Turtle(s)	<i>Hydromedusa</i> Spp.	N.C, CI		28	
Southeast Asian Box Turtle	<i>Cuora amboinensis</i>	N.C, EM		42	
Southeast Asian Box Turtle	<i>Cuora amboinensis kamaroma</i>	N.C, EM		42*	
Southeastern Hinge-back Turtle	<i>Kinixys belliana zombensis</i>	C, TE	5*		
Southern Pacific Pond Turtle	<i>Clemmys marmorata pallida</i>	N.C, EM		49*	
Southern Painted Turtle	<i>Chrysemys picta dorsalis</i>	N.C, EM		50*	
Southern Saltwater Terrapin	<i>Batagur baska</i>	C, EM		47	
Southern Soft-shell Turtle	<i>Apalone ferox</i>	N.C, TR		24	
Southern Speckled Cape Tortoise	<i>Homopus signatus cafer</i>	C, TE		18*	
Southern Spider Tortoise	<i>Pyxis arachnoides oblonga</i>	C, TE		7*	
Southern Spotted Box Turtle	<i>Terrapene nelsoni nelsoni</i>	C, EM		44	
Southern White-lipped Mud Turtle	<i>Kinosternon leucostomum postinguinale</i>	N.C, KI		34*	
Southern Wood Tortoise	<i>Geochelone chilensis</i>	C, TE		11	
Speckled Cape Tortoise	<i>Homopus signatus</i>	C, TE		18	
Speckled Tortoise	<i>Homopus signatus</i>	C, TE		18	
Speke's Hinge-back Turtle	<i>Kinixys belliana spekii</i>	C, TE	5*		
Spider Tortoise	<i>Pyxis arachnoides</i>	C, TE		7	
Spider Tortoise(s)	<i>Pyxis</i> Spp.	C, TE		7, 18	
Spineless Soft-shell	<i>Apalone mutica</i>	N.C, TR		25	
Spiny Soft-shell Turtle	<i>Apalone spinifera</i>	N.C, TR		13	
Spiny Turtle	<i>Heosemys spinosa</i>	N.C, EM		53	
Spiny-neck Turtle	<i>Acanthochelys spixii</i>	N.C, CI		26	
Spiny-necked Turtle	<i>Acanthochelys spixii</i>	N.C, CI		26	
Spix's Sideneck Turtle	<i>Acanthochelys spixii</i>	N.C, CI		26	
Spotted Box Turtle	<i>Terrapene nelsoni</i>	C, EM		44	
Spotted Pond Turtle	<i>Geoclemys hamiltonii</i>	C, EM		60	
Spotted Turtle	<i>Clemmys guttata</i>	N.C, EM		49	
Spur Thigh Tortoise	<i>Geochelone sulcata</i>	C, TE		10	
Spurred Tortoise	<i>Geochelone sulcata</i>	C, TE		10	
Spur-thighed Tortoise	<i>Testudo graeca</i>	C, TE		16	
Sri Lanka Black Turtle	<i>Melanochelys trijuga thermalis</i>	N.C, EM		61*	
Star Tortoise	<i>Geochelone elegans</i>	C, TE		5	
Steppe Tortoise	<i>Testudo horsfieldii</i>	C, TE		17	
Sternotherus derbianus	<i>Pelusios castaneus</i>	C, PE-5		30	1
Sternotherus sinuatus	<i>Pelusios sinuatus</i>	N.C, PE-13		30*	1
Sternotherus minor	<i>Sternotherus minor</i>	N.C, KI		36	

*符號表示物種或亞種在本圖鑑未說明

附錄B

英文名	學名	管制,科名	藍	黃	橘
Sternotherus odoratus	Sternotherus odoratus	N.C, KI		35	
Sternotherus Spp.	Sternotherus Spp.	N.C, KI		35, 36	
Stinking Jim Turtle	Sternotherus odoratus	N.C, KI		35	
Stinkpot Turtle	Sternotherus odoratus	N.C, KI		35	
Stripe Neck Wood Turtle	Cyclemys tcheponensis	N.C, EM		54	
Stripe-backed Side-necked Turtle	Pelusios gabonensis	C, PE-8		30*	1
Striped Mud Turtle	Kinosternon baurii	N.C, KI		34	
Stripe-necked Leaf Turtle	Cyclemys tcheponensis	N.C, EM		54	
Stripe-necked Musk Turtle	Sternotherus minor peltifer	N.C, KI		36*	
Stripe-necked Musk Turtle	Sternotherus minor	N.C, KI		36	
Sub-saharan Flapshell Turtle(s)	Cyclanorbis Spp.	N.C, TR	7		
Subsahelian Flapshell Turtle	Cyclanorbis elegans	N.C, TR	7		
Swamp Tortoise(s)	Acanthochelys Spp.....	N.C-C, CI		26 - 29	
Swamp turtle	Emys orbicularis	N.C, EM		45	
Swamp Turtle	Morenia ocellata	C, EM		58	
Swamp Turtle(s)	Acanthochelys Spp.....	N.C-C, CI		26 - 29	
T					
Tabasco Central American River Turtle	Dermatemys mawii	C, DE		39	
Tabasco Mud Turtle	Kinosternon acutum	N.C, KI		37	
Temple Softshell	Aspideretes nigricans	C, TR		22	
Tent Tortoise	Psammobates tentorius	C, TE		6	
Tent Turtle	Kachuga tecta	C, EM		57	
Terecay Turtle	Podocnemis unifilis	C, PE		33	
Terrapene carolina	Terrapene carolina	C, EM		43	
Terrapene coahuila	Terrapene coahuila	C, EM		43	
Terrapene nelsoni	Terrapene nelsoni	C, EM		44	
Terrapene ornata	Terrapene ornata	C, EM		44	
Terrapene Spp.	Terrapene Spp.	C, EM		43, 44	
Testudo hermanni	Testudo hermanni	C, TE		16	
Testudo kleinmanni	Testudo kleinmanni	C, TE		17	
Testudo marginata	Testudo marginata	C, TE		14	
Testudo mydas	Chelonia mydas	C, CH	2		
Testudo polyphemus	Gopherus polyphemus	C, TE		12	
Testudo scripta	Trachemys scripta	N.C, EM		52	
Testudo Spp.	Testudo Spp.	C, TE		14, 16, 17	
Testudo yniphora	Geochelone yniphora	C, TE		13	
Texas Diamondback Terrapin	Malaclemys terrapin littoralis	N.C, EM		58*	
Texas Gopher Tortoise	Gopherus berlandieri	C, TE		12	
Texas Spiny Softshell Turtle	Apalone spinifera emoryi	N.C, TR		13*	
Texas Tortoise	Gopherus berlandieri	C, TE		12	
Texas-Gopherschildkröte	Gopherus berlandieri	C, TE		12	
Thailand Big-headed Turtle	Platysternon m. vogeli	N.C, PT	9*		
Thailand Black Turtle	Melanochelys trijuga wiroti	N.C, EM		61*	
Three-banded Box Turtle	Cuora trifasciata	N.C, EM		41	
Three-keeled Box Turtle	Cuora trifasciata	N.C, EM		41	
Three-keeled Indian Terrapin	Melanochelys tricarinata	C, EM		61	
Three-keeled Land Tortoise	Melanochelys tricarinata	C, EM		61	
Three-lined Box Turtle	Cuora trifasciata	N.C, EM		41	
Three-striped Box Turtle	Cuora trifasciata	N.C, EM		41	
Three-toed Box Turtle	Terrapene carolina triunguis	C, EM		43*	
Tobasco Mud Turtle	Kinosternon acutum	N.C, KI		37	
Toobasco Turtle	Dermatemys mawii	C, DE		39	
Toothed Cape Tortoise	Psammobates oculiferus	C, TE		6	
Tornier's Tortoise	Malacochersus tornieri	C, TE		7	
Tortoise(s)	Testudo Spp.....	C, TE	5	2 - 20	
True Land Tortoise(s)	Testudo Spp.....	C, TE	5	2 - 20	
True Tortoise(s)	Testudo Spp.....	C, TE	5	2 - 20	
Trunkback Turtle	Dermochelys coriacea	C, DO	4		
Turkey Pond Turtle	Emys orbicularis luteofusca	N.C, EM		45*	
Turtle(s)	Testudo Spp.....	C, TE	5	2 - 20	
Twist-neck Turtle	Platemys platycephala	N.C, CI		27	
Twist-necked Turtle	Platemys platycephala	N.C, CI		27	
Typical Tortoise(s)	Geochelone Spp.	C, TE		2 - 20	
U					
Ukerewe Island Mud Turtle	Pelusios williamsi laurenti	N.C, PE-16		30*	1
Unechte Karettschildkröte	Caretta caretta	C, CH	3		
Upemba Mud Turtle	Pelusios upembae	N.C, PE-15		30*	1
V					
Variable Mud Turtle	Pelusios rhodesianus	N.C, PE-11		30*	1

*符號表示物種或亞種在本圖鑑未說明

附錄B

英文名	學名	管制,科名	藍	黃	橘
Venezuelan Slider	<i>Trachemys scripta chichiriviche</i>	N.C, EM		52*	
Vietnam Big-headed Turtle	<i>Platysternon m. shiui</i>	N.C, PT	9*		
Vietnam Box Turtle	<i>Cuora galbinifrons galbinifrons</i>	N.C, EM		41	
Vietnamese Box Turtle	<i>Cuora galbinifrons galbinifrons</i>	N.C, EM		41	
Vietnamese Leaf Turtle	<i>Annamemys annamensis</i>	N.C, EM		62	
Volcan Alcedo Tortoise	<i>Geochelone nigra vandenburghi</i>	C, TE		2*	
Volcan Darwin Giant Tortoise	<i>Geochelone nigra microphyes</i>	C, TE		2*	
Volcan Darwin Tortoise	<i>Geochelone nigra microphyes</i>	C, TE		2*	
Volcan Wolf Tortoise	<i>Geochelone nigra becki</i>	C, TE		2*	
W					
Water Box Turtle	<i>Terrapene coahuila</i>	C, EM		43	
Wattle-necked Softshell Turtle	<i>Palea steindachneri</i>	N.C, TR		23	
West African Black Turtle	<i>Pelusios niger</i>	C, PE-10		30*	1
West African Hinged Tortoise	<i>Kinixys belliana</i>	C, TE	5		
West African Mud Turtle	<i>Pelusios castaneus</i>	C, PE-5		30	1
West Indonesian Box Turtle	<i>Cuora amboinensis couro</i>	N.C, EM		42*	
Western Box Turtle	<i>Terrapene ornata</i>	C, EM		44	
Western Chicken Turtle	<i>Deirochelys reticularia miaria</i>	N.C, EM		47*	
Western Gopher Tortoise	<i>Gopherus agassizi</i>	C, TE		12	
Western Hermann's Tortoise	<i>Testudo hermanni hermanni</i>	C, TE		16	
Western Hinge-back Turtle	<i>Kinixys belliana nogueyi</i>	C, TE	5*		
Western Leopard Tortoise	<i>Geochelone pardalis pardalis</i>	C, TE		10	
Western Painted Turtle	<i>Chrysemys picta bellii</i>	N.C, EM		50*	
Western Pond Turtle	<i>Clemmys marmorata</i>	N.C, EM		49	
Western Short-necked Turtle	<i>Pseudemys umbrina</i>	C, CI		27	
Western Spiny Softshell Turtle	<i>Apalone spinifera hartwegi</i>	N.C, TR		13*	
Western Swamp Tortoise	<i>Pseudemys umbrina</i>	C, CI		27	
Western Swamp Turtle	<i>Pseudemys umbrina</i>	C, CI		27	
Western Tent Tortoise	<i>Psammobates tentorius trimeni</i>	C, TE		6*	
White-breasted Side-necked Turtle	<i>Pelusios adansonii</i>	C, PE-1		30*	1
White-fronted Box Turtle	<i>Cuora galbinifrons</i>	N.C, EM		41	
White-lipped Mud Turtle	<i>Kinosternon leucostomum</i>	N.C, KI		34	
White-throated Mud Turtle	<i>Kinosternon scorpioides albogulare</i>	N.C, KI		38*	
William's African Mud Turtle	<i>Pelusios williamsi</i>	N.C, PE-16		30*	1
William's Mud Turtle	<i>Pelusios williamsi</i>	N.C, PE-16		30*	1
William's Pelomedusid Turtle	<i>Pelusios williamsi</i>	N.C, PE-16		30*	1
William's Side-necked Turtle	<i>Pelusios williamsi</i>	N.C, PE-16		30*	1
Wood Tortoise	<i>Geochelone carbonaria</i>	C, TE		9	
Wood Turtle	<i>Clemmys insculpta</i>	C, EM		54	
X					
Y					
Yaqui Slider	<i>Trachemys scripta yaquia</i>	N.C, EM		52*	
Yellow and Black Giant Tortoise	<i>Manouria emys</i>	C, TE		13	
Yellow Bellied Turtle	<i>Trachemys scripta</i>	N.C, EM		52	
Yellow Bordered Tortoise	<i>Gopherus flavomarginatus</i>	C, TE		19	
Yellow Mud Turtle	<i>Kinosternon flavescens flavescens</i>	N.C, KI		34	
Yellow Tortoise	<i>Indotestudo elongata</i>	C, TE		17	
Yellow-bellied Mud Turtle	<i>Pelusios castanoides</i>	N.C, PE-6		30*	1
Yellow-bellied Slider	<i>Trachemys scripta scripta</i>	N.C, EM		52	
Yellow-bellied Tent Turtle	<i>Kachuga tentoria flaviventer</i>	N.C, EM		57*	
Yellow-bellied Tent Turtle	<i>Kachuga tentoria</i>	N.C, EM		57	
Yellow-foot Tortoise	<i>Geochelone denticulata</i>	C, TE		9	
Yellow-footed Tortoise	<i>Geochelone denticulata</i>	C, TE		9	
Yellow-headed Box Turtle	<i>Cuora flavomarginata</i>	N.C, EM		42	
Yellow-headed Sideneck	<i>Podocnemis unifilis</i>	C, PE		33	
Yellow-headed Temple Turtle	<i>Hieremys annandalii</i>	N.C, EM		56	
Yellow-headed Tortoise	<i>Indotestudo elongata</i>	C, TE		17	
Yellow-margined Box Turtle	<i>Cuora flavomarginata</i>	N.C, EM		42	
Yellow-spotted River Turtle	<i>Podocnemis unifilis</i>	C, PE		33	
Yellow-spotted Amazon River Turtle	<i>Podocnemis unifilis</i>	C, PE		33	
Yellow-spotted Amazon Turtle	<i>Podocnemis unifilis</i>	C, PE		33	
Yellow-spotted Sideneck Turtle	<i>Podocnemis unifilis</i>	C, PE		33	
Yucatan Box Turtle	<i>Terrapene carolina yucatanana</i>	C, EM		43*	
Yunnan Big-headed Turtle	<i>Platysternon m. tristernalis</i>	N.C, PT	9*		

*符號表示物種或亞種在本圖鑑未說明

Index C

附錄C

深灰色附錄頁為附錄C。

附錄C 為常見藥用龜板來源物種表，學名乃依照字母的順序排列，並附有中英文名。

附錄C 常見藥用龜板來源物種表

學名	中英名	出現頁碼	CITES名錄	野保法保育類 野生動物名錄
<i>Chinemys reevesii</i>	金龜 (烏龜) Reeves' turtle	62		珍貴稀有
<i>Cuora amboinensi</i>	安布閉殼龜 Malayan box turtle	42		
<i>Cuora flavomarginata</i>	食蛇龜 (黃緣閉殼龜) Yellow-margined box turtle	42		
<i>Cuora galbinifrons</i>	黃額閉殼龜 Indochinese box turtle	41		
<i>Cuora trifasciata</i>	三線閉殼龜 Chinese three-striped box turtle	41		
<i>Cyclemys dentata</i>	齒緣攝龜 Asian leaf turtle	40		
<i>Geochelone elegans</i>	印度星龜 Indian star tortoise	5	附錄II	珍貴稀有
<i>Geochelone pardalis</i>	豹紋陸龜 Leopard tortoise	10	附錄II	珍貴稀有
<i>Geoemyda spengleri</i>	黑胸地龜 Black-breasted leaf turtle	60		
<i>Heosemys grandis</i>	亞洲巨龜 Giant Asian pond turtle	53		
<i>Hieremys annandalei</i>	黃頭廟龜 Temple turtle	56		
<i>Indotestudo elongata</i>	緬甸陸龜 (黃頭象龜) Elongated tortoise	17	附錄II	珍貴稀有
<i>Kachuga tecta</i>	印度鋸背龜 Indian roofed turtle (Indian pond turtle)	57	附錄 I	瀕臨絕種
<i>Malayemys subtrijuga</i>	馬來食螺龜 Malayan snail-eating turtle	62		
<i>Manouria emys</i>	亞洲棕龜 Asian brown tortoise	13	附錄 II	珍貴稀有
<i>Manouria impressa</i>	凹甲陸龜 Impressed tortoise	18	附錄 II	珍貴稀有
<i>Morenia ocellata</i>	緬甸眼斑沼龜 (緬甸孔雀龜) Burmese eyed turtle	58	附錄 I	瀕臨絕種
<i>Notochelys platynota</i>	馬來果龜 Malayan flat-shelled turtle	40		
<i>Ocadia sinensis</i>	斑龜 Chinese stripe-necked turtle	48		
<i>Orlitia borneensis</i>	馬來巨龜 Malaysian giant turtle	47		
<i>Platysternum megacephalum</i>	大頭龜 (平胸龜) Big-headed turtle	9		
<i>Pyxidea mouhotii</i>	鋸緣攝龜 Keeled box turtle	40		
<i>Siebenrockiella crassicollis</i>	粗頸龜 Black marsh turtle	54		

註一：所列CITES名錄乃依據1997年CITES第十次大會決議的名錄。

註二：所列野生動物保育法保育類野生動物名錄係依據行政院農業委員會84年12月23日(84)農林字第4030817A號公告辦理。

註三：此表係根據中國醫藥學院(台灣台中)張賢哲教授所著之常見藥用龜板圖鑑所列。

國家圖書館出版品預行編目資料

CITES辨識圖鑑—龜類／拉夫爾 (Yvan Lafleur)
等著；陳添喜、陳楊文譯—初版—台北市：
農委會，1999民88
面：公分-- (農委會林業特刊：第64號)
含索引
譯自：CITES Identification Guide: Turtles and
Tortoises
ISBN 957-02-5259-6 (平裝)
1. 龜—圖錄
388.791 88017367



書名：CITES辨識圖鑑—龜類
原書名：CITES Identification Guide: Turtles and Tortoises
著者：拉夫爾 (Yvan Lafleur)，嘉勒哥 (Flor Amparo Leyva Gallegos)，
夏綠蒂 (Richard Charette)，馬理巴爾 (Tamara Malippaard)
譯者：陳添喜、陳楊文
編輯：湯曉虞、方國運、李芬蘭、陳楊文、曾詩琴
編譯：台北野生貿易研究委員會 (TRAFFIC East Asia-Taipei)、
自然生態保育協會
發行人：林享能
出版者：行政院農業委員會
地址：100台北市南海路37號
電話：02-23812291
印刷：自然國有限公司
初版一刷：1999年12月
GPN 025037880019
ISBN 957-02-5259-6 (平裝)

農委會林業特刊第64號
版權所有，請勿翻印